



# PRESSURE RELIEF VALVE ENGINEERING HANDBOOK

# PRESSURE RELIEF VALVE ENGINEERING HANDBOOK

## FORWARD

---

Copyright © 2012, 2021 Emerson. All rights reserved. No part of this publication may be reproduced or distributed in any form or by any means, or stored in a database or retrieval system, without written permission. Emerson provides the information herein in good faith but makes no representation as to its comprehensiveness or accuracy. Individuals using this information in this publication must exercise their independent judgment in evaluating product selection and determining product appropriateness for their particular purpose and system requirements. Emerson makes no representations or warranties, either express or implied, including without limitation any warranties of merchantability or fitness for a particular purpose with respect to the information set forth herein or the product(s) to which the information refers. Accordingly, Emerson will not be responsible for damages (of any kind or nature, including incidental, direct, indirect, or consequential damages) resulting from the use of or reliance upon this information. Emerson reserves the right to change product designs and specifications without notice. All registered trademarks are the property of their respective owners. Printed in the USA.

# PRESSURE RELIEF VALVE ENGINEERING HANDBOOK

## CONTENTS

---

### TABLE OF CONTENTS

---

Chapter 1 - Introduction .....	1.1
Chapter 2 - Terminology .....	2.1
I. General.....	2.1
II. Types of Devices .....	2.1
III. Parts of Pressure Relief Devices .....	2.1
IV. Dimensional Characteristics - Pressure Relief Valves .....	2.2
V. Operational Characteristics - Pressure Relief Devices.....	2.3
VI. System Characteristics.....	2.4
Chapter 3 - Codes and Standards .....	3.1
I. Introduction .....	3.3
II. American Society of Mechanical Engineers (ASME) Boiler and Pressure Vessel Code .....	3.3
III. International Organization for Standardization (ISO).....	3.18
IV. European Union Directives .....	3.22
V. American Petroleum Institute (API).....	3.23
VI. National Fire Protection Agency (NFPA) .....	3.26
VII. National Board of Boiler and Pressure Vessel Inspectors .....	3.27
Chapter 4 - Design Fundamentals .....	4.1
I. Introduction .....	4.3
II. Direct Spring Operated Pressure Relief Valves .....	4.3
III. Pilot Operated Pressure Relief Valves.....	4.15
IV. Advantages and Limitations of Valve Types.....	4.27
Chapter 5 - Valve Sizing and Selection (USCS Units).....	5.1
I. Introduction .....	5.3
II. Gas/Vapor Sizing - Sonic Flow .....	5.4
III. Gas/Vapor Sizing - Subsonic Flow .....	5.5
IV. Steam Sizing.....	5.5
V. Liquid Sizing.....	5.11
VI. Fire Sizing .....	5.11
VII. Two-Phase Flow Sizing.....	5.18
VIII. Noise Level Calculations .....	5.25
IX. Reaction Forces.....	5.26
Chapter 6 - Valve Sizing and Selection (Metric Units).....	6.1
I. Introduction .....	6.3
II. Gas/Vapor Sizing - Sonic Flow .....	6.4
III. Gas/Vapor Sizing - Subsonic Flow .....	6.5
IV. Steam Sizing.....	6.6
V. Liquid Sizing.....	6.11
VI. Fire Sizing .....	6.13
VII. Two-Phase Flow Sizing.....	6.15
VIII. Noise Level Calculations .....	6.23
IX. Reaction Forces.....	6.24

# PRESSURE RELIEF VALVE ENGINEERING HANDBOOK

## CONTENTS

---

### TABLE OF CONTENTS (CONTINUED)

---

Chapter 7 - Engineering Support Information (USCS Units) .....	7.1
I. Compressibility Factor.....	7.3
II. Capacity Correction Factor for Back Pressure.....	7.4
III. Capacity Correction Factor for High Pressure Steam.....	7.31
IV. Capacity Correction Factor for Viscosity.....	7.31
V. Capacity Correction Factor for Superheat.....	7.33
VI. Ratio of Specific Heats and Coefficient C .....	7.35
VII. Typical Fluid Properties .....	7.36
VIII. Saturated Steam Pressure Table.....	7.40
IX. Orifice Area and Coefficient of Discharge for Anderson Greenwood and Crosby Pressure Relief Valves.....	7.41
X. Equivalentents and Conversion Factors .....	7.48
XI. Capacity Correction Factor for Rupture Disc/Pressure Relief Valve Combination .....	7.54
Chapter 8 - Engineering Support Information (Metric Units) .....	8.1
I. Compressibility Factor .....	8.3
II. Capacity Correction Factor for Back Pressure.....	8.4
III. Capacity Correction Factor for High Pressure Steam.....	8.31
IV. Capacity Correction Factor for Viscosity.....	8.31
V. Capacity Correction Factor for Superheat.....	8.33
VI. Ratio of Specific Heats and Coefficient C .....	8.35
VII. Typical Fluid Properties .....	8.36
VIII. Saturated Steam Pressure Table.....	8.40
IX. Orifice Area and Coefficient of Discharge for Anderson Greenwood and Crosby Pressure Relief Valves.....	8.41
X. Equivalentents and Conversion Factors .....	8.48
XI. Capacity Correction Factor for Rupture Disc/Pressure Relief Valve Combination .....	8.54

# PRESSURE RELIEF VALVE ENGINEERING HANDBOOK

## CHAPTER 1 - INTRODUCTION

---

The primary purpose of a pressure or vacuum relief valve is to protect life and property by venting process fluid from an overpressurized vessel or adding fluid (such as air) to prevent formation of a vacuum strong enough to cause a storage tank to collapse.

Proper sizing, selection, manufacture, assembly, testing, installation, and maintenance of a pressure relief valve are all critical for optimal protection of the vessel or system.

Please note that the brand names of pressure relief devices covered (Anderson Greenwood, Crosby, Whessoe and Varec) are of Emerson manufacture. A specific valve brand is selected, according to pressure range, temperature range, valve size, industry application and other applicable factors.

This manual has been designed to provide a service to Emerson customers by presenting reference data and technical recommendations based on over 125 years of pioneering research, development, design, manufacture and application of pressure relief valves. Sufficient data is supplied so that an individual will be able to use this manual as an effective aid to properly size and select Emerson-manufactured pressure relief devices for specific applications. Information covering terminology, standards, codes, basic design, sizing and selection are presented in an easy to use format.

The information contained in this manual is offered as a guide. The actual selection of valves and valve products is dependent on numerous factors and should be made only after consultation with qualified Emerson personnel. Those who utilize this information are reminded of the limitations of such publications and that there is no substitute for qualified engineering analysis.

Emerson pressure relief devices are manufactured in accordance with a controlled quality assurance program which meets or exceeds ASME Code quality control requirements. Capacities of valves with set pressures of 15 psig (1.03 barg), or higher, are certified by the National Board of Boiler and Pressure Vessel Inspectors. These attributes are assured by the presence of an ASME Code Symbol Stamp and the letters NB on each pressure relief valve nameplate. Lower set pressures are not addressed by either the National Board or ASME; however, capacities at lower set pressures have been verified by actual testing at Emerson's extensive flow lab facilities. Emerson's range of pressure relief valves are designed, manufactured, and tested in strict accordance with a quality management system approved to the International Standard Organization's ISO 9000 quality standard requirements. With proper sizing and selection, the user can thus be assured that Emerson's products are of the highest quality and technical standards in the world of pressure relief technology.

When in doubt as to the proper application of any particular data, the user is advised to contact the nearest Emerson sales office or sales representative. Emerson has a large staff of highly trained personnel strategically located throughout the world, who are available for your consultation.

Emerson has designed and has available to customers a computer sizing program for pressure relief valves, PRV2SIZE (Pressure Relief Valve and Vent Sizing Software). The use of this comprehensive program allows an accurate and documented determination of such parameters as pressure relief valve orifice area and maximum available flow.

This sizing program is a powerful tool, yet easy to use. Its many features include quick and accurate calculations, user-selected units of measurement, selection of pressure relief valve size and style, valve data storage, printed reports, valve specification sheets and outline drawings. Program control via pop-up windows, function keys, extensive on-line help facilities, easy-to-read formatted screens, flagging of errors, and easy editing of displayed inputs make the program easy to understand and operate.

It is assumed that the program user has a general understanding of pressure relief valve sizing calculations. The program user must remember they are responsible for the correct determination of service conditions and the various data necessary for input to the sizing program.

For download instructions for the latest PRV2SIZE please contact your sales representative or factory.

**The information in this manual is not to be used for ASME Section III nuclear applications. If you need assistance with pressure relief valves for ASME Section III service, please contact our nuclear industry experts at 508-384-3121.**

# PRESSURE RELIEF VALVE ENGINEERING HANDBOOK

## CHAPTER 2 - TERMINOLOGY

---

This chapter contains common and standardized terminology related to pressure relief devices used throughout this handbook and is in accordance with, and adopted from, ANSI/ASME Performance Test Code PTC-25-2008 and other widely accepted practices.

### I. GENERAL

---

#### Bench Testing

Testing of a pressure relief device on a test stand using an external pressure source with or without an auxiliary lift device to determine some or all of its operating characteristics.

#### Flow Capacity Testing

Testing of a pressure relief device to determine its operating characteristics including measured relieving capacity.

#### In-Place Testing

Testing of a pressure relief device installed on but not protecting a system, using an external pressure source, with or without an auxiliary lift device to determine some or all of its operating characteristics.

#### In-Service Testing

Testing of a pressure relief device installed on and protecting a system using system pressure or an external pressure source, with or without an auxiliary lift device to determine some or all of its operating characteristics.

#### Pressure Relief Device

A device designed to prevent pressure or vacuum from exceeding a predetermined value in a pressure vessel by the transfer of fluid during emergency or abnormal conditions.

### II. TYPES OF DEVICES

---

#### Pressure Relief Valve (PRV)

A pressure relief device designed to actuate on inlet static pressure and to reclose after normal conditions have been restored. It may be one of the following types and have one or more of the following design features.

- A. Restricted lift PRV: a pressure relief valve in which the actual discharge area is determined by the position of the disc.
- B. Full lift PRV: a pressure relief valve in which the actual discharge area is not determined by the position of the disc.
- C. Reduced bore PRV: a pressure relief valve in which the flow path area below the seat is less than the flow area at the inlet to the valve.
- D. Full bore PRV: a pressure relief valve in which the bore area is equal to the flow area at the inlet to the valve and there are no protrusions in the bore.
- E. Direct spring loaded PRV: a pressure relief valve in which the disc is held closed by a spring.
- F. Pilot operated PRV: a pressure relief valve in which a piston or diaphragm is held closed by system pressure and the holding pressure is controlled by a pilot valve actuated by system pressure.
- G. Conventional direct spring loaded PRV: a direct spring loaded pressure relief valve whose operational characteristics are directly affected by changes in the back pressure.

- H. Balanced direct spring loaded PRV: a direct spring loaded pressure relief valve which incorporates means of minimizing the effect of back pressure on the operational characteristics (opening pressure, closing pressure, and relieving capacity).
- I. Internal spring PRV: a direct spring loaded pressure relief valve whose spring and all or part of the operating mechanism is exposed to the system pressure when the valve is in the closed position.
- J. Temperature and pressure relief valve: a pressure relief valve that may be actuated by pressure at the valve inlet or by temperature at the valve inlet.
- K. Power actuated PRV: a pressure relief valve actuated by an externally powered control device.

#### Safety Valve

A pressure relief valve characterized by rapid opening or closing and normally used to relieve compressible fluids.

#### Relief Valve

A pressure relief valve characterized by gradual opening or closing generally proportional to the increase or decrease in pressure. It is normally used for incompressible fluids.

#### Safety Relief Valve

A pressure relief valve characterized by rapid opening or closing or by gradual opening or closing, generally proportional to the increase or decrease in pressure. It can be used for compressible or incompressible fluids.

### III. PARTS OF PRESSURE RELIEF DEVICES

---

**Adjusting Ring:** a ring assembled to the nozzle and/or guide of a direct spring valve used to control the opening characteristics and/or the reseal pressure.

**Adjustment Screw:** a screw used to adjust the set pressure or the reseal pressure of a reclosing pressure relief device.

**Backflow Preventer:** a part or a feature of a pilot operated pressure relief valve used to prevent the valve from opening and flowing backwards when the pressure at the valve outlet is greater than the pressure at the valve inlet.

**Bellows:** a flexible component of a balanced direct spring valve used to prevent changes in set pressure when the valve is subjected to a superimposed back pressure, or to prevent corrosion between the disc holder and guide.

**Blowdown Ring:** see adjusting ring.

**Body:** a pressure retaining or containing member of a pressure relief device that supports the parts of the valve assembly and has provisions(s) for connecting to the primary and/or secondary pressure source(s).

**Bonnet:** a component of a direct spring valve or of a pilot in a pilot operated valve that supports the spring. It may or may not be pressure containing.

**Cap:** a component used to restrict access and/or protect the adjustment screw in a reclosing pressure relief device. It may or may not be a pressure containing part.

**Diaphragm:** a flexible metallic, plastic, or elastomer member of a reclosing pressure relief device used to sense pressure or provide opening or closing force.

**Disc:** a moveable component of a pressure relief device that contains the primary pressure when it rests against the nozzle.

**Disc Holder:** a moveable component in a pressure relief device that contains the disc.

**Dome:** the volume of the side of the unbalanced moving member opposite the nozzle in the main relieving valve of a pilot operated pressure relief device.

**Field Test:** a device for in-service or bench testing of a pilot operated pressure relief device to measure the set pressure.

**Gag:** a device used on reclosing pressure relief devices to prevent the valve from opening.

**Guide:** a component in a direct spring or pilot operated pressure relief device used to control the lateral movement of the disc or disc holder.

**Huddling Chamber:** the annular pressure chamber between the nozzle exit and the disc or disc holder that produces the lifting force to obtain lift.

**Lift Lever:** a device to apply an external force to the stem of a pressure relief valve to manually operate the valve at some pressure below the set pressure.

**Main Relieving Valve:** that part of a pilot operated pressure relief device through which the rated flow occurs during relief.

**Nozzle:** a primary pressure containing component in a pressure relief valve that forms a part or all of the inlet flow passage.

**Pilot:** the pressure or vacuum sensing component of a pilot operated pressure relief valve that controls the opening and closing of the main relieving valve.

**Piston:** the moving element in the main relieving valve of a pilot operated, piston type pressure relief valve which contains the seat that forms the primary pressure containment zone when in contact with the nozzle.

**Pressure Containing Member:** a component which is exposed to and contains pressure.

**Pressure Retaining Member:** a component which holds one or more pressure containing members together but is not exposed to the pressure.

**Seat:** the pressure sealing surfaces of the fixed and moving pressure containing components.

**Spindle:** a part whose axial orientation is parallel to the travel of the disc. It may be used in one or more of the following functions:

- a. assist in alignment,
- b. guide disc travel, and
- c. transfer of internal or external forces to the seats.

**Spring:** the element in a pressure relief valve that provides the force to keep the disc on the nozzle.

**Spring Step:** a load transferring component in a pressure relief valve that supports the spring.

**Spring Washer:** see spring step.

**Spring Button:** see spring step.

**Stem:** see spindle.

**Yoke:** a pressure retaining component in a pressure relief device that supports the spring in a pressure relief valve but does not enclose the spring from the surrounding ambient environment.

#### IV. DIMENSIONAL CHARACTERISTICS - PRESSURE RELIEF VALVES

---

**Actual Discharge Area:** the measured minimum net area which determines the flow through a valve.

**Actual Orifice Area:** see actual discharge area.

**Bore Area:** the minimum cross-sectional flow area of a nozzle.

**Bore Diameter:** the minimum diameter of a nozzle.

**Curtain Area:** the area of the cylindrical or conical discharge opening between the seating surfaces created by the lift of the disc above the seat.

**Developed Lift:** the actual travel of the disc from closed position to the position reached when the valve is at flow rating pressure.

**Discharge Area:** see actual discharge area.

**Effective Discharge Area:** a nominal or computed area of flow through a pressure relief valve used with an effective discharge coefficient to calculate minimum required relieving capacity.

**Effective Orifice Area:** see effective discharge area.

**Inlet Size:** the nominal pipe size of the inlet of a pressure relief valve, unless otherwise designated.

**Lift:** the actual travel of the disc away from closed position when a valve is relieving.

**Nozzle Area, Nozzle Throat Area:** see bore area.

**Nozzle Diameter:** see bore diameter.

**Outlet Size:** the nominal pipe size of the outlet of a pressure relief valve, unless otherwise designated.

**Rated Lift:** the design lift at which a valve attains its rated relieving capacity.

**Seat Angle:** the angle between the axis of a valve and the seating surface. A flat-seated valve has a seat angle of 90 degrees.

**Seat Area:** the area determined by the seat diameter.

**Seat Diameter:** the smallest diameter of contact between the fixed and moving portions of the pressure containing elements of a valve.

**Seat Flow Area:** see curtain area.

**Throat Area:** see bore area.

**Throat Diameter:** see bore diameter.

### V. OPERATIONAL CHARACTERISTICS OF PRESSURE RELIEF DEVICES

---

**Back Pressure:** the static pressure existing at the outlet of a pressure relief device due to pressure in the discharge system. It is the sum of superimposed and built-up back pressure.

**Blowdown:** the difference between actual set pressure of a pressure relief valve and actual reseating pressure, expressed as a percentage of set pressure or in pressure units.

**Blowdown Pressure:** the value of decreasing inlet static pressure at which no further discharge is detected at the outlet of a pressure relief valve after the valve has been subjected to a pressure equal to or above the set pressure.

**Built-Up Back Pressure:** pressure existing at the outlet of a pressure relief device caused by the flow through that particular device into a discharge system.

**Chatter:** abnormal, rapid reciprocating motion of the moveable parts of a pressure relief valve in which the disc contacts the seat.

**Closing Pressure:** the value of decreasing inlet static pressure at which the valve disc re-establishes contact with the seat or at which lift becomes zero.

**Coefficient of Discharge:** the ratio of the measured relieving capacity to the theoretical relieving capacity.

**Cold Differential Test Pressure:** the inlet static pressure at which a pressure relief valve is adjusted to open on the test stand. This test pressure includes corrections for service conditions of superimposed back pressure and/or temperature. Abbreviated as CDTP and stamped on the nameplate of a pressure relief valve.

**Constant Back Pressure:** a superimposed back pressure which is constant with time.

**Cracking Pressure:** see opening pressure.

**Dynamic Blowdown:** the difference between the set pressure and closing pressure of a pressure relief valve when it is overpressured to the flow rating pressure.

**Effective Coefficient of Discharge:** a nominal value used with the effective discharge area to calculate the minimum required relieving capacity of a pressure relief valve.

**Flow Capacity:** see measured relieving capacity.

**Flow Rating Pressure:** the inlet stagnation pressure at which the relieving capacity of a pressure relief device is measured.

**Flutter:** abnormal, rapid reciprocating motion of the movable parts of a pressure relief valve in which the disc does not contact the seat.

**Leak Pressure:** see start-to-leak pressure.

**Leak Test Pressure:** the specified inlet static pressure at which a quantitative seat leakage test is performed in accordance with a standard procedure.

**Marked Set Pressure:** the value or values of pressure marked on a pressure relief device.

**Marked Relieving Capacity:** see rated relieving capacity.

**Measured Relieving Capacity:** the relieving capacity of a pressure relief device measured at the flow rating pressure, expressed in gravimetric or volumetric units.

**Opening Pressure:** the value of increasing static pressure of a pressure relief valve at which there is a measurable lift, or at which the discharge becomes continuous as determined by seeing, feeling, or hearing.

**Overpressure:** a pressure increase over the set pressure of a pressure relief valve, usually expressed as a percentage of set pressure.

**Popping Pressure:** the value on increasing inlet static pressure at which the disc moves in the opening direction at a faster rate as compared with corresponding movement at higher or lower pressures.

**Primary Pressure:** the pressure at the inlet in a pressure relief device.

**Rated Coefficient of Discharge:** the coefficient of discharge determined in accordance with the applicable code or regulation and is used with the actual discharge area to calculate the rated flow capacity of a pressure relief valve.

**Rated Relieving Capacity:** that portion of the measured relieving capacity permitted by the applicable code or regulation to be used as a basis for the application of a pressure relief device.



**Reference Conditions:** those conditions of a test medium which are specified by either an applicable standard or an agreement between the parties to the test, which may be used for uniform reporting of measured flow test results.

**Relieving Conditions:** the inlet pressure and temperature on a pressure relief device during an overpressure condition. The relieving pressure is equal to the valve set pressure plus the overpressure. (The temperature of the flowing fluid at relieving conditions may be higher or lower than the operating temperature.)

**Relieving Pressure:** set pressure plus overpressure.

**Resealing Pressure:** the value of decreasing inlet static pressure at which no further leakage is detected after closing. The method of detection may be a specified water seal on the outlet or other means appropriate for this application.

**Resealing Pressure:** see closing pressure.

**Seal-Off Pressure:** see resealing pressure.

**Secondary Pressure:** the pressure existing in the passage between the actual discharge area and the valve outlet in a safety, safety relief, or relief valve.

**Set Pressure:** the value of increasing inlet static pressure at which a pressure relief device displays one of the operational characteristics as defined under opening pressure, popping pressure or start-to-leak pressure. (The applicable operating characteristic for a specific device design is specified by the device manufacturer.)

**Simmer:** the audible or visible escape of fluid between the seat and disc at an inlet static pressure below the popping pressure and at no measurable capacity. It applies to safety or safety relief valves on compressible fluid service.

**Start-to-Discharge Pressure:** see opening pressure.

**Start-to-Leak Pressure:** the value of increasing inlet static pressure at which the first bubble occurs when a pressure relief valve is tested by means of air under a specified water seal on the outlet.

**Static Blowdown:** the difference between the set pressure and the closing pressure of a pressure relief valve when it is not overpressured to the flow rating pressure.

**Superimposed Back Pressure:** the static pressure existing at the outlet of a pressure relief device at the time the device is required to operate. It is the result of pressure in the discharge system from other sources and may be constant or variable.

**Test Pressure:** see relieving pressure.

**Theoretical Relieving Capacity:** the computed capacity expressed in gravimetric or volumetric units of a theoretically perfect nozzle having a minimum cross-sectional flow area equal to the actual discharge area of a pressure relief valve or net flow area of a non-reclosing pressure relief device.

**Vapor-Tight Pressure:** see resealing pressure.

**Variable Back Pressure:** a superimposed back pressure that will vary with time.

**Warn:** see simmer.

## VI. SYSTEM CHARACTERISTICS

---

**Accumulation:** is the pressure increase over the maximum allowable working pressure (MAWP) of the process vessel or storage tank allowed during discharge through the pressure relief device. It is expressed in pressure units or as a percentage of MAWP or design pressure. Maximum allowable accumulations are typically established by applicable codes for operating and fire overpressure contingencies.

**Design Pressure:** is the pressure of the vessel along with the design temperature that is used to determine the minimum permissible thickness or physical characteristic of each vessel component as determined by the vessel design rules. The design pressure is selected by the user to provide a suitable margin above the most severe pressure expected during normal operation at a coincident temperature. It is the pressure specified on the purchase order. This pressure may be used in place of the maximum allowable working pressure (MAWP) in all cases where the MAWP has not been established. The design pressure is equal to or less than the MAWP.

**Maximum Allowable Working Pressure:** is the maximum gauge pressure permissible at the top of a completed process vessel or storage tank in its normal operating position at the designated coincident temperature specified for that pressure. The pressure is the least of the values for the internal or external pressure as determined by the vessel design rules for each element of the vessel using actual nominal thickness, exclusive of additional metal thickness allowed for corrosion and loadings other than pressure. The maximum allowable working pressure (MAWP) is the basis for the pressure setting of the pressure relief devices that protect the vessel. The MAWP is normally greater than the design pressure but must be equal to the design pressure when the design rules are used only to calculate the minimum thickness for each element and calculations are not made to determine the value of the MAWP.

**Maximum Operating Pressure:** is the maximum pressure expected during normal system operation.

# PRESSURE RELIEF VALVE ENGINEERING HANDBOOK

## CHAPTER 3 - CODES AND STANDARDS

---

### THE FOLLOWING DATA IS INCLUDED IN THIS CHAPTER

---

I.	Introduction.....	3.3
II.	American Society of Mechanical Engineers (ASME) Boiler and Pressure Vessel Code .....	3.3
	Section I - Rules for Construction of Power Boilers.....	3.3
	Section VIII - Rules for Construction of Pressure Vessels .....	3.9
	PTC 25 - Performance Test Code.....	3.18
	B16.34 - Valves - Flanged, Threaded and Welded Ends.....	3.18
	B16.5 - Pipe Flanges and Flanges Fittings.....	3.18
III.	International Organization for Standardization (ISO).....	3.18
	ISO 4126 - Safety Devices for Protection Against Excessive Pressure.....	3.18
	ISO 23251 - Petroleum and Natural Gas Industries - Pressure Relieving and Depressurizing Systems .....	3.21
	ISO 28300 - Petroleum and Natural Gas Industries - Venting of Atmospheric and Low Pressure Storage Tanks .....	3.21
IV.	European Union Directives .....	3.22
	Pressure Equipment Directive (PED) 97/23/EC.....	3.22
	ATEX Directive 94/9/EC .....	3.23
V.	American Petroleum Institute (API).....	3.23
	API Standard/Recommended Practice 520 - Sizing, Selection and Installation of Pressure Relieving Devices in Refineries .....	3.23
	API Standard 521 - Guide to Pressure Relieving and Depressuring Systems.....	3.23
	API Standard 526 - Flanged Steel Pressure Relief Valves.....	3.24
	API Standard 527 - Seat Tightness of Pressure Relief Valves .....	3.24
	API Standard 2000 - Venting Atmospheric and Low Pressure Storage Tanks .....	3.24
	API Recommended Practice 576 - Inspection of Pressure Relief Devices .....	3.25
	API Standard 620 - Design and Construction of Large, Welded, Low Pressure Storage Tanks .....	3.25
	API Standard 625 - Tank Systems for Refrigerated Liquid Gas Storage .....	3.25
	API Standard 650 - Welded Steel Tanks for Oil Storage.....	3.26
VI.	National Fire Protection Agency (NFPA) .....	3.26
	NFPA 30 - Flammable and Combustible Liquids Code.....	3.26
	NFPA 58 - Liquefied Petroleum Gas Code .....	3.26
	NFPA 59A - Standard for the Production, Storage and Handling of Liquefied Natural Gas (LNG).....	3.27
VII.	National Board of Boiler and Pressure Vessel Inspectors.....	3.27
	National Board Inspection Code (NBIC) 23 .3.27 NB18 Pressure Relief Device Certifications.....	3.28

# PRESSURE RELIEF VALVE ENGINEERING HANDBOOK

## CHAPTER 3 - CODES AND STANDARDS

---

### THE FOLLOWING FIGURES ARE INCLUDED IN THIS CHAPTER

---

Figure 3-1	Typical Section I Single PRV Installation .....	3.4
Figure 3-2	Typical Section I Multiple PRV Installation .....	3.5
Figure 3-3	Direct Spring Operated PRV with Lift Lever .....	3.7
Figure 3-4	Pilot Operated PRV Field Test Assembly.....	3.7
Figure 3-5	Safety Selector Valve.....	3.8
Figure 3-6	Recommended ASME Section I Piping Arrangement .....	3.8
Figure 3-7	Typical Section VIII Single Device Installation (Non-Fire) - Set at the MAWP of the Vessel.....	3.10
Figure 3-8	Typical Section VIII Single Device Installation (Non-Fire) - Set below the MAWP of the Vessel .....	3.11
Figure 3-9	Typical Section VIII Single Device Installation (Fire) - Set at the MAWP of the Vessel.....	3.12
Figure 3-10	Typical Section VIII Multiple Valve (Non-Fire Case) Installation.....	3.13
Figure 3-11	Typical Section VIII Multiple Valve (Fire Case) Installation.....	3.14
Figure 3-12	Typical ASME Section VIII Nameplate.....	3.18
Figure 3-13	Isolation Valve Requirements.....	3.20
Figure 3-14	PRV Discharge Piping Example .....	3.21
Figure 3-15	API 527 Leak Test for Gas Service .....	3.24

### THE FOLLOWING TABLES ARE INCLUDED IN THIS CHAPTER

---

Table 3-1	Section I Set Pressure Tolerances .....	3.7
Table 3-2	ASME Section VIII Set Pressure Tolerance .....	3.16
Table 3-3	Design Basis for Sizing Downstream Piping.....	3.21
Table 3-4	API 527 Leakage Rate Acceptance for Metal Seated PRV (Gas Service).....	3.25

### I. INTRODUCTION

---

This section will provide highlights (please note this is not a complete review) of several commonly used global codes, standards and recommended practices that may be referenced when selecting pressure relief valves. The documents that are listed in this handbook are subject to revision and the user should be aware that the following information may not reflect the most current editions.

### II. AMERICAN SOCIETY OF MECHANICAL ENGINEERS (ASME) BOILER AND PRESSURE VESSEL CODE

---

There is information contained within various sections in the Code that provide rules for design, fabrication, testing, materials and certification of appurtenances, such as pressure relief valves that are used in the new construction of a boiler or pressure vessel. The scope of this handbook will limit this discussion to the Section I and Section VIII portion of the Code. The text is based upon the 2013 revision of the Code.

#### Section I - Rules for Construction of Power Boilers

##### Scope

The general requirements found in part PG of the Section I Code provides rules that are applicable to the construction of new boilers that generate steam at a pressure equal to or more than 15 psig (1.03 barg). In addition, these rules will apply to the construction of new hot water boilers that operate above 160 psig (11.0 barg) and/or when the operating temperature exceeds 250°F (120°C). For boilers that operate outside of these parameters, the user may wish to review Section IV of the Code that deals with rules for heating boilers.

##### Acceptable Valve Designs

ASME Section I traditionally allowed only the use of direct acting spring loaded pressure relief valves, but the use of self-actuated pilot operated pressure relief valves is now allowed. The use of power-actuated pressure relief valves can be used in some circumstances for a forced-flow steam generator. No other types of pressure relief valves or non-closing devices such as rupture disks can be used for this section of the Code.

##### Allowable Vessel Accumulation

One requirement in Section I is that the maximum accumulation allowed during an overpressure event must be limited to 6% when one pressure relief valve is used to provide protection. There are specific rules listed in Section I that will oftentimes require the use of two or more pressure relief valves to provide protection. More details on these multiple valve installation requirements are found in Chapter 5 (USCS units) or Chapter 6 (Metric units) that deal with sizing and selection. When multiple PRVs are used, the allowable accumulation for a fired vessel remains at 6%. For a single PRV installation, the Code will allow the highest set pressure to be equal to maximum allowable working pressure (MAWP).

Therefore, the design of this valve must allow adequate lift to obtain the needed capacity within 6% overpressure. Chapter 4 of the handbook will discuss how the design of a Section I valve provides this needed lift with minimal overpressure. Although most users desire this highest possible set pressure (equal to MAWP) to avoid unwanted cycles, the Code does allow this PRV to be set below the MAWP.

For a multiple PRV installation, the Code will allow for a staggered or variable set pressure regime for the valves. This helps to avoid interaction between the safety valves during their open and closing cycle. As noted above, the accumulation rule allows for 6% rise in pressure above the MAWP. One of the multiple valves, sometimes called the primary pressure relief valve, must still be set no higher than the MAWP but the additional or supplemental pressure relief valve can be set up to a maximum of 3% above the MAWP. In this case, the same valve design criteria, obtaining the needed valve lift with 3% overpressure, is still required. The Code requires that the overall range of set pressures for a multiple valve installation not exceed 10% of the highest set pressure PRV. Figures 3-1 and 3-2 help to illustrate the single and multiple valve installation.

#### Pressure Relief Valve Certification Requirements

The ASME organization itself does not do the actual inspection and acceptance of a pressure relief valve design to meet the requirements of the Code. Traditionally, it has been the National Board of Boiler and Pressure Vessel Inspectors (National Board) that has been designated by the ASME to perform this duty.

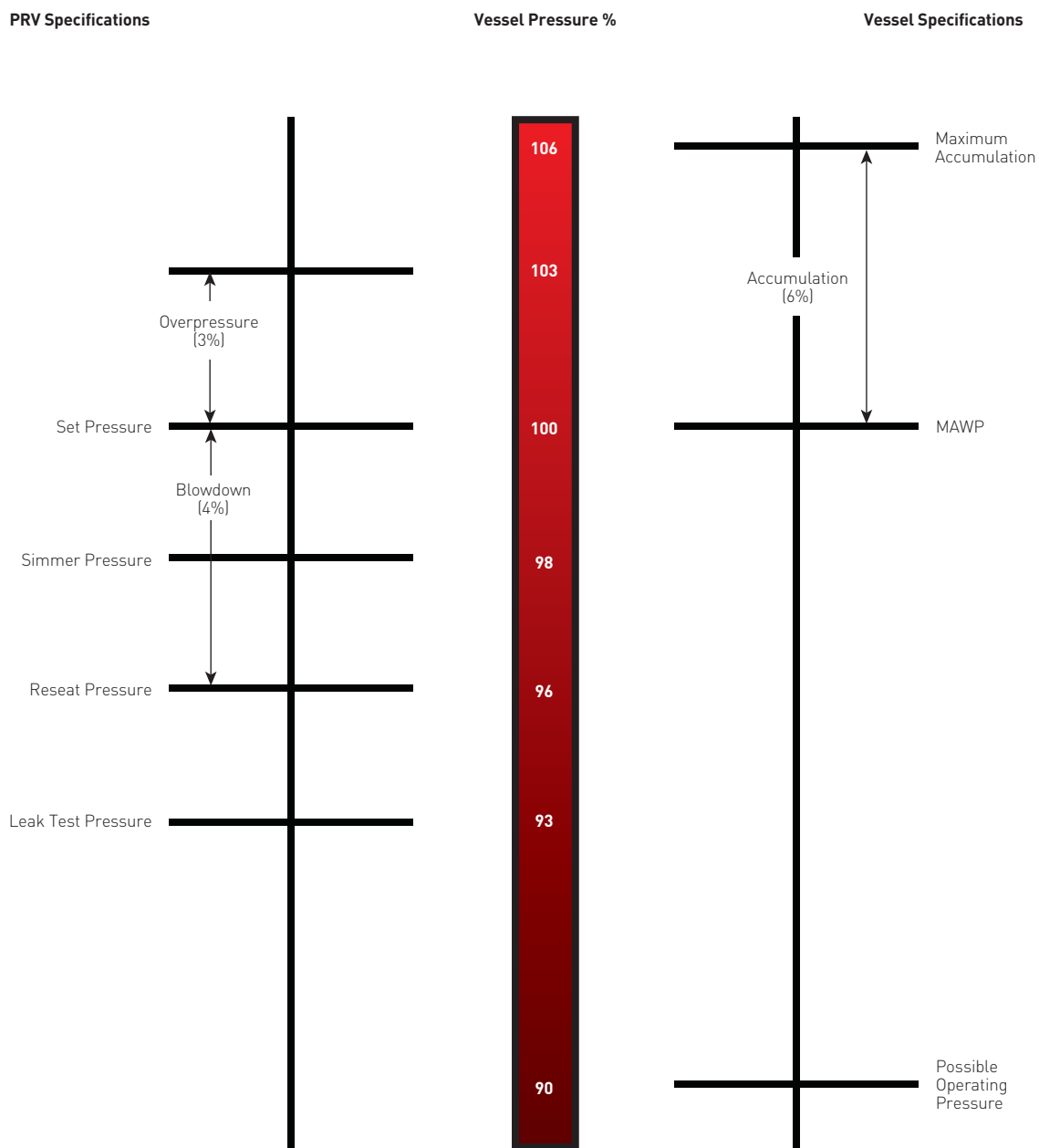
One test that is performed is to demonstrate that an individual valve will provide the capacity of steam that is expected when the valve is called upon to relieve. For each combination of valve and orifice size, valve design and set pressure, there are to be three valves tested to measure their capacity. These capacity certification tests are done with saturated steam at a flowing pressure using the greater of 3% or 2 psi (0.138 bar) overpressure. The requirement is that the measured capacity from any of the three valves must fall within a plus or minus 5% of the average capacity of the three valve test. If one valve were to fail to meet this criteria, then rules in the Code allow for two more valves to be tested. Now, all four valves must fall within a plus or minus 5% of the average capacity of all four valves now tested. If either of the two additional valves fail to meet this range, then valve certification is denied.

When the valve capacity certification is approved, this individual valve will be given a rated capacity that is 90% of the average capacity found during the testing. It is this rated capacity that is used to size and select valves per the ASME Section I procedures in Chapters 5 and 6.

# PRESSURE RELIEF VALVE ENGINEERING HANDBOOK

## CHAPTER 3 - CODES AND STANDARDS

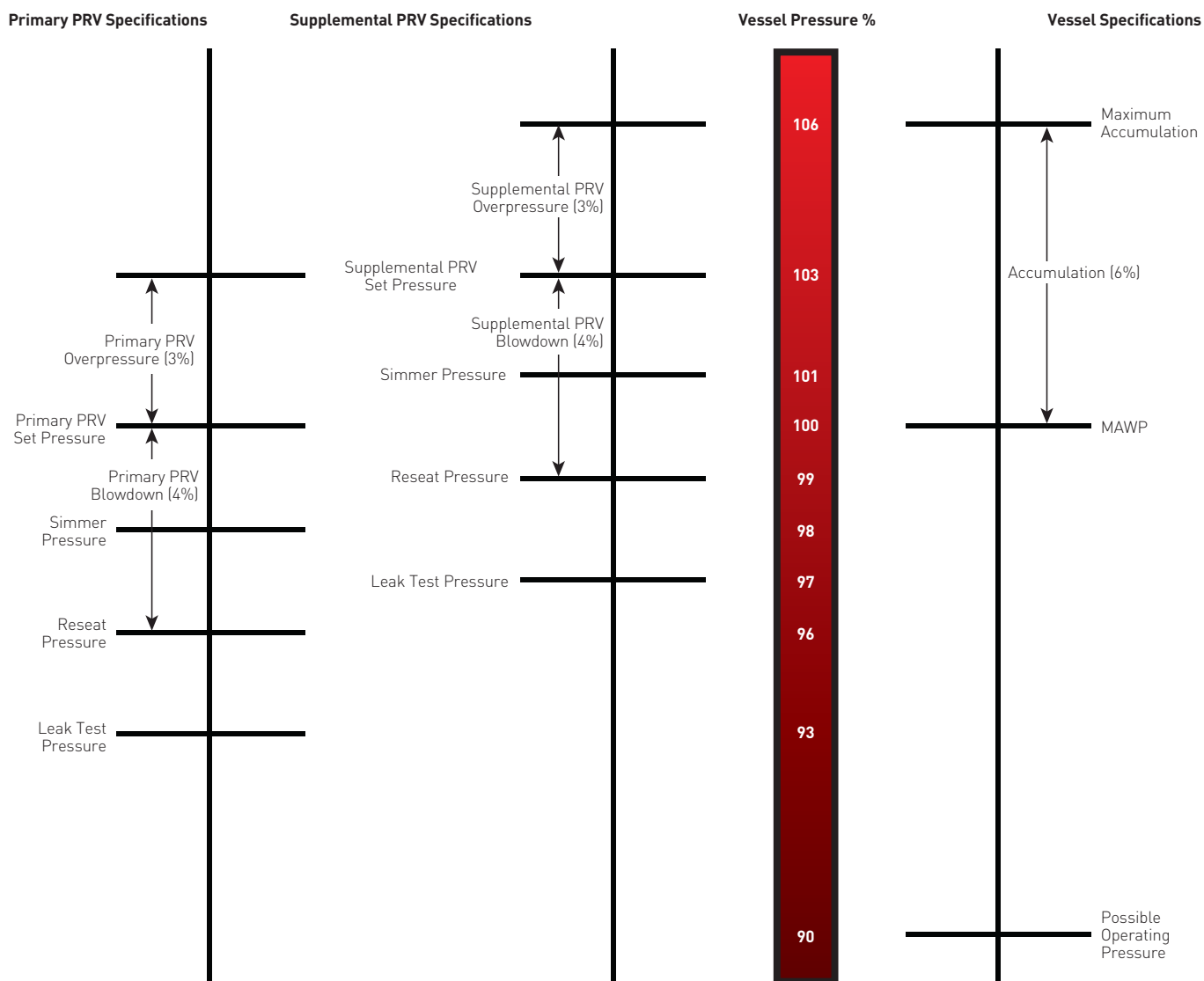
FIGURE 3-1  
Typical Section I Single PRV Installation



# PRESSURE RELIEF VALVE ENGINEERING HANDBOOK

## CHAPTER 3 - CODES AND STANDARDS

FIGURE 3-2  
Typical Section I Multiple PRV Installation



This three valve test is normally used for a very narrow, oftentimes non-standard, application. Please note that the set pressure cannot vary in order to provide a code stamp for the safety valve. If a safety valve will be used in multiple applications that have different set pressures, then another capacity certification test procedure can be used. A ratio of the measured capacity over the flowing pressure (using an overpressure of 3% or 2 psi (0.138 bar), whichever is greater) is established with testing four valves of the same connection and orifice size. These four valves are tested at different set pressures that would be representative of their expected application. This ratio is plotted to give a slope that will determine the straight line relationship between the capacity and the flowing pressure of the valve during relief.

All four valves tested must fall within plus or minus 5% of the average straight line slope. If one valve were to fall outside of this plus or minus 5% range, then two additional valves can be tested. No more than four additional valves can be tested or the certification will be denied.

When the valve capacity certification is approved then the rated slope, used to size and select valves, is limited to 90% of the average slope measured during testing.

A third, and frequently used, capacity certification test is available when the design of a safety valve encompasses many different sizes and set pressure requirements. One requirement for grouping different size safety valves as one specific design family is that the ratio of the valve bore diameter to the valve inlet diameter must not exceed the range of 0.15 to 0.75 when the nozzle of the valve controls the capacity. If the lift of the valve trim parts controls the capacity, then the lift to nozzle diameter (L/D) of the safety valves in the design family must be the same.

Once the design family is determined, then three valve sizes from the family and three valves for each size, for a total of nine valves, are tested to measure their capacity with steam. Once again, these flow tests are done with 3% or 2 psi (0.138 bar), whichever is greater. These measured values are compared to the expected theoretical capacity delivered through an ideal nozzle or flow area where there are no losses to reduce flow. A coefficient of discharge ( $K_d$ ) is denoted for each of the nine tests as follows:

$$K_d = \frac{\text{Actual Flow}}{\text{Theoretical Flow}}$$

Similar to the other two capacity tests above, each of the nine values of  $K_d$  must fall within plus or minus 5% of the average of the nine tests. If one valve falls outside of this range then two more valves may be tested, up to a limit of four total additional valves. When excluding the replaced valves, the  $K_d$  of all valves tested must fall in the plus or minus 5% of the overall average or the certification is denied.

If the capacity certification test is successful, then the rated coefficient of discharge (K) is established for the valve design family. The K is equal to 90% of the  $K_d$  value.

In addition to establishing the rated capacities, the certification testing will also require that the blowdown of any Section I valve be demonstrated not to exceed 4% when the certification set pressure is above 100 psig (6.90 barg) or not to exceed 4 psi (0.276 bar) when the certification set pressure is below 100 psig (6.90 barg).

If a pressure relief valve is to be used to protect an economizer (see Figure 5-2 or 6-1) then this device must be capacity certified on water as well as saturated steam. The same set pressure tolerances and maximum blowdown criteria that is required for steam as the test media is also required for water as the test media.

The Code requires that the manufacturer demonstrate that each individual pressure relief valve or valve design family tested per the above requirements also provide similar operational performance when built on the production line. Therefore, every six years, two production valves are chosen for each individual valve or valve design family for set pressure, capacity, and blowdown testing. As with the initial certification testing an ASME designated third party, such as the National Board, is present to witness these production valve tests.

**Pressure Relief Valve Design Criteria**

Each production PRV must have its set pressure demonstrated with the valve being tested on steam. When the testing equipment and valve configuration will allow, this set pressure test is done by the manufacturer prior to shipping. If the set pressure requirement is higher or the test drum volume requirement is larger than the capabilities that reside at the manufacturing facility, then the valve can be sent to the site, mounted on the boiler and tested. This in situ testing is rarely performed today due to safety concerns and possible damage to the safety valve and other equipment. The Code recognizes these concerns and will allow the manufacturer to use two alternative methods to demonstrate the set pressure on steam.

When there is limited capacity on the test stand, the rapid opening of a steam safety valve will deplete the force holding the seat in lift during testing. This can damage the seating surfaces during the reclosure of the valve. Therefore, one alternative method is to limit the lift of the safety valve seat when tested. This can be done by externally blocking the movement of the valve trim parts, such as the spindle assembly shown in Figure 3-3, that move upward when the safety valve opens. If this restricted lift test is performed, the manufacturer must mechanically confirm the actual required lift is met.

# PRESSURE RELIEF VALVE ENGINEERING HANDBOOK

## CHAPTER 3 - CODES AND STANDARDS

When the required set pressure exceeds the manufacturer’s test boiler capabilities, another acceptable alternate test method is to use what is called a lift assist device. These devices attach to the same spindle assembly discussed above. The safety valve is subjected to the steam pressure from the test boiler. Since the test boiler pressure is limited, the lift assist device must have the ability to add upward lifting force, typically via some hydraulically powered system, to overcome the spring compression. The lift assist device has instrumentation that can measure the upward force being applied. Using the safety valve seat dimensions and the operating pressure from the test boiler, the set pressure can be determined with minimal lift of the seat. As with the restricted lift test above, the manufacturer must mechanically confirm the actual required lift is met.

A recent change in the Section I Code does not require a demonstrated test of the valve blowdown for production safety valves. For example, the typical blowdown setting for a production Section I PRV is 4% for valves set above 375 psig (25.9 barg) and the valve adjustments are to be set per manufacturer’s instructions to reflect this blowdown.

Since the test stand accumulators are of limited volume in a valve manufacturing environment, there is no requirement to measure the capacity of a production safety valve. The initial certification and renewal testing of valve capacities are discussed above.

A seat leakage test is required at the maximum expected operating pressure, or at a pressure not exceeding the reseal pressure of the valve. The requirement is that there is to be no visible leakage.

Each production PRV will have its pressure containing components either hydrostatically tested at 1.5 times the design of the part or pneumatically tested at 1.25 times the design of the part. This proof test is now required even for non-cast pressure containing parts such as bar stock or forgings where the test pressures could exceed 50% of their allowable stress. A pressure containing part made in a cast or welded form will always be proof tested no matter what its allowable stress may be.

FIGURE 3-3  
Direct Spring Operated PRV with Lift Lever

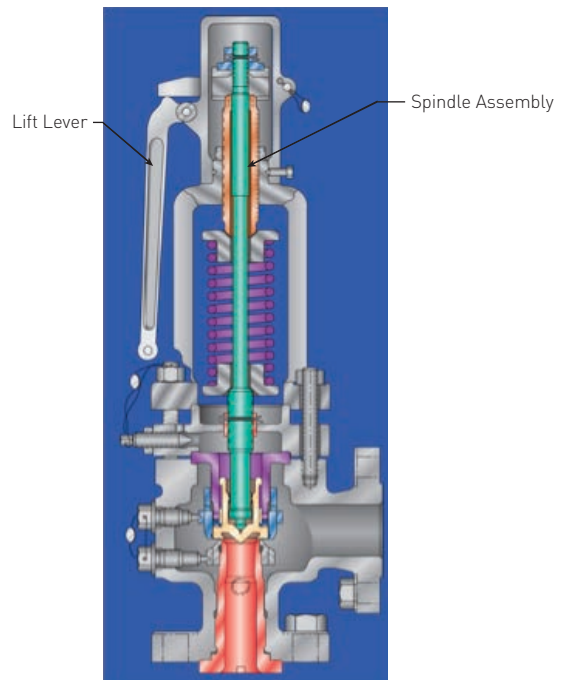


FIGURE 3-4  
Pilot Operated PRV Field Test Assembly

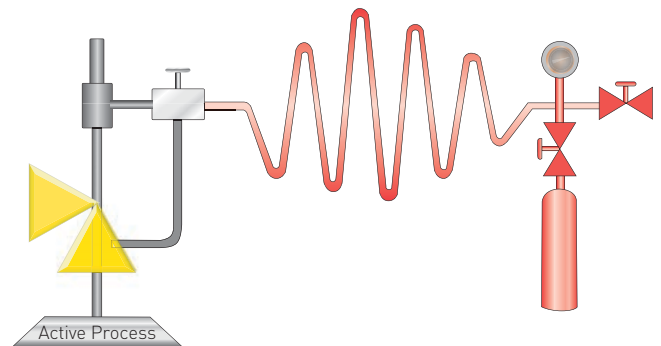


TABLE 3-1 - SECTION I SET PRESSURE TOLERANCES

Set Pressure, psig (barg)	Tolerance (plus or minus) from the set pressure
Less than or equal to 70 (4.82)	2 psi (0.137 bar)
More than 70 (4.82) and equal to or less than 300 (20.7)	3% of the set pressure
More than 300 (20.7) and equal to or less than 1000 (70.0)	10 psi (0.690 bar)
More than 1000 (70.0)	1% of the set pressure



A Section I PRV with an inlet that is equal to or greater than 3" (80 mm) in size must have a flanged or welded inlet connection. Any PRV with an inlet less than 3" (80 mm) can have a screwed, flanged or welded connection.

All pressure relief valves must have a device to check if the trim parts are free to move when the valve is exposed to a minimum of 75% of its set pressure. This device is normally a lift lever (see Figure 3-3) for a direct spring loaded or pilot operated valve. A pilot operated valve may also use what is called a field test connection, where an external pressure can be supplied to function the valve (see Figure 3-4).

**Pressure Relief Valve Installation**

There are specific maximum lengths of inlet piping specified by ASME Section I that mandate a close coupling of the safety valve to the vessel. The inlet and outlet piping shall have at least the area of the respective valve inlet or outlet area. If there are multiple valves mounted on one connection, then this connection must have an area at least as large as the two safety valves inlet connection areas in total. These installation requirements are extremely important for these safety valves that have very minimal blowdown settings. There will be more on this topic in Chapter 4.

There can be no intervening isolation valve between the vessel and the safety valve. There also cannot be any isolation valve downstream of the safety valve.

An exception to the mandate of no isolation valves for the inlet connection of a Section I safety valve lies in what is called an ASME Code Case. These code cases are not a part of the main body of the document as they are a vehicle to respond to inquiries asking for clarifications or alternatives to the rules. These code cases may be published as often as four times a year and their implementation is immediate when there is latitude that has been granted to modify a requirement. In some instances, a code case will become a part of the Code in some future revision.

Code Case 2254 allows the use of diverter, or changeover valves, when the steam drum has a MAWP of 800 psig (55.2 barg) or less. The Anderson Greenwood Safety Selector Valve (see Figure 3-5) is a diverter valve that will meet the requirements laid out in the code case. These requirements include that the diverter valve never be in a position where both safety valves could be blocked at the same time, there must be a positive indication of the active safety valve, vent valves to safely bleed pressure for a newly isolated safety valve are to be provided, and that a minimum flow coefficient ( $C_v$ ) is met. With any code case, the device, in this instance the diverter valve, must be marked with the Code Case 2254 on the nameplate.

FIGURE 3-5  
 Safety Selector Valve

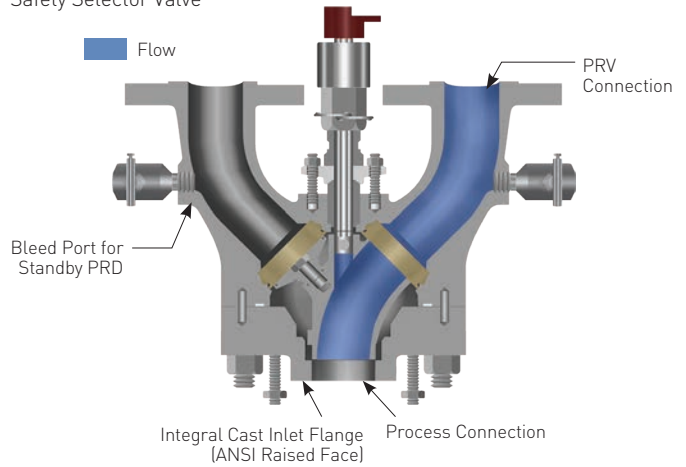
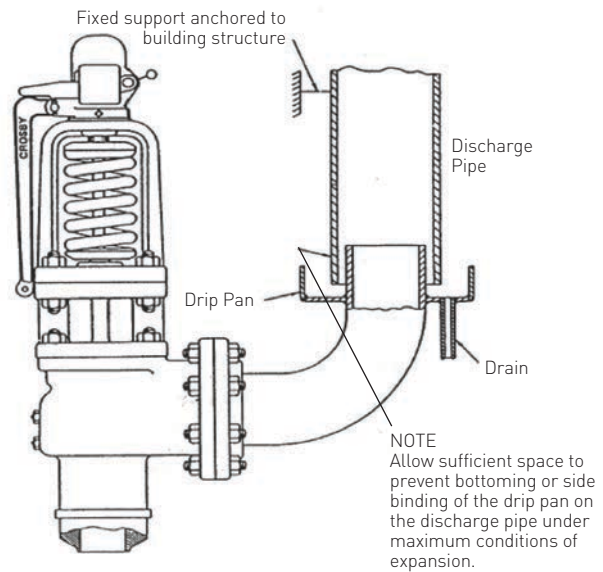


FIGURE 3-6  
 Recommended ASME Section I Piping Arrangement



The discharge piping is also required to be short and straight as possible and also designed to reduce stress on the safety valve body. It is not uncommon to find the outlet piping causing distortion of the valve body which in turn causes the seat and nozzle to not properly align, therefore causing leakage. The discharge piping should also be designed to eliminate condensation and water to gather in the discharge of the safety valve. Figure 3-6 illustrates an ideal installation with a short discharge angled tailpipe that is inserted into, but not attached to, an externally supported pipe riser.

### Assemblers

There is wording in the Code that defines a manufacturer as the entity that is responsible for meeting the design criteria to produce the valve components that can be put together to build a valve that has been certified by the testing requirements listed above. This approval by the ASME designee to produce valves with a Code stamp symbol is specific to the manufacturer's physical location.

To best serve the user community, the Code allows the manufacturer to designate other locations that will inventory valve components to efficiently build and test pressure relief valves that mirror those produced at the manufacturer's location. These organizations are called "assemblers," and are allowed to assemble, adjust, test and code stamp certified designs. They are required to use OEM parts to assemble valves, and can only purchase these parts direct from the manufacturer or another certified assembler. The assembler is required to use the same assembly and test procedures as the manufacturer and is not allowed to machine or fabricate parts. An assembler may be owned by the manufacturer, or be a separate entity.

As with the manufacturer's location, an assembler has their quality system reviewed and approved by an ASME designated third party, such as the National Board. The assembler most likely will not be able to produce all of the valves that are certified by the manufacturer per the Code and they must define in detail what valve designs they can assemble and what, if any limitations, there may be in the actions taken to configure these valve designs to meet the customer requirements.

As with the manufacturer, the Code requires that the assembler demonstrate that each individual pressure relief valve or valve design family where they are approved, be tested. Therefore, every six years, two assembler built valves are chosen for each individual valve or valve design family and are sent in for set pressure, capacity, and valve stability testing. As with the manufacturer production valve testing, an ASME designated third party, such as the National Board, is present to witness these production valve tests.

This assembler program is strictly to be used to provide new, not repaired, pressure relief valves.

### Nameplates

All pressure relief valves built in accordance with ASME Section I are required to have specific information contained on a nameplate that is attached to the valve. The manufacturer's name along with the assembler's name, if applicable, is to be shown. The rated capacity is to be shown in superheated steam for reheaters and superheaters (see Figures 5-2 or 6-1), water and saturated steam for economizers, and saturated steam for other Section I locations. Recall that this rated capacity is 90% of that measured during certification testing at a flowing pressure at 3% overpressure or 2 psi (0.138 bar) whichever is greater. The valve model number, set pressure and inlet size are also required fields for the nameplate.

You can identify a pressure relief valve that has been certified to ASME Section I by locating a "V" marked on the nameplate.

In addition to this nameplate identification, the PRV is required to have all parts used in the adjustment of the set pressure and blowdown to be sealed by the manufacturer or assembler. This seal will carry the identification of which authorized facility built and tested the PRV.

### Section VIII - Rules for Construction of Pressure Vessels

#### Scope

Division I of ASME Section VIII will provide rules for the new construction of vessels which contain pressure that is supplied via an external source or pressure generated by heat input or a combination of both. Since the designs of these vessels can be numerous, it may be easier to provide examples of what type of pressure containers might not be considered an ASME Section VIII vessel. Some common examples can include the following:

- Vessels having an inside diameter or cross section diagonal not exceeding 6" (152 mm) of any length at any design pressure.
- Vessels having a design pressure below 15 psig (1.03 barg).
- Fired tubular heaters.
- Components, such as pump casings or compressor cylinders, of a moving mechanical piece of equipment that are a part of the device and designed to meet the working conditions of the device.
- Piping systems that are required to transport gases or liquids between areas.

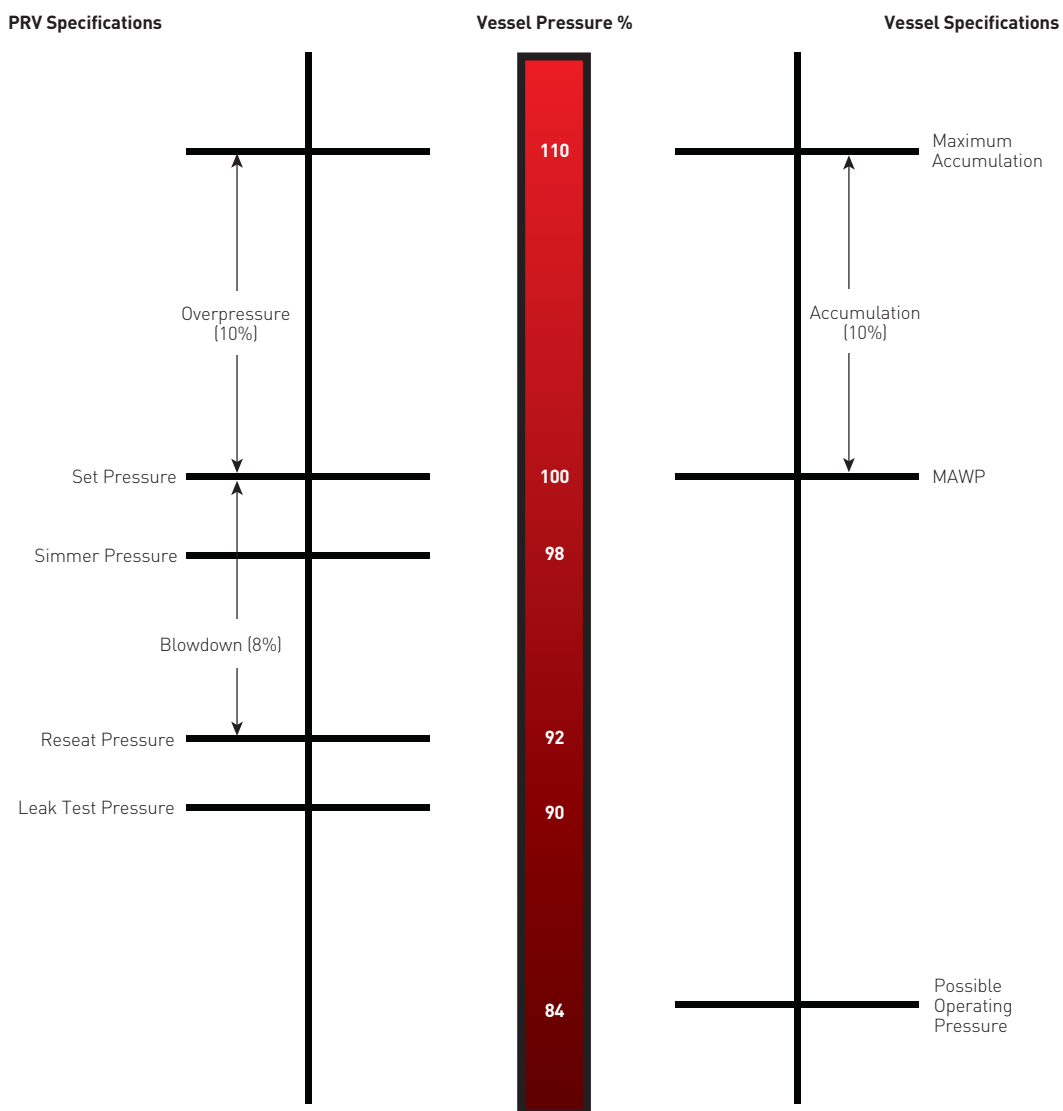
The reader should note that there may be local or country statutes that determine whether or not a certain vessel is to conform to the rules of ASME Section VIII.

The requirements for ASME Section VIII are less stringent than those in Section I. It is permissible to use a PRV certified for Section I in any Section VIII application provided that the design will meet all of the requirements of the application.

# PRESSURE RELIEF VALVE ENGINEERING HANDBOOK

## CHAPTER 3 - CODES AND STANDARDS

FIGURE 3-7  
Typical Section VIII Single Device Installation (Non-Fire) - Set at the MAWP of the Vessel



# PRESSURE RELIEF VALVE ENGINEERING HANDBOOK

## CHAPTER 3 - CODES AND STANDARDS

FIGURE 3-8  
 Typical Section VIII Single Device Installation (Non-Fire) - Set below the MAWP of the Vessel

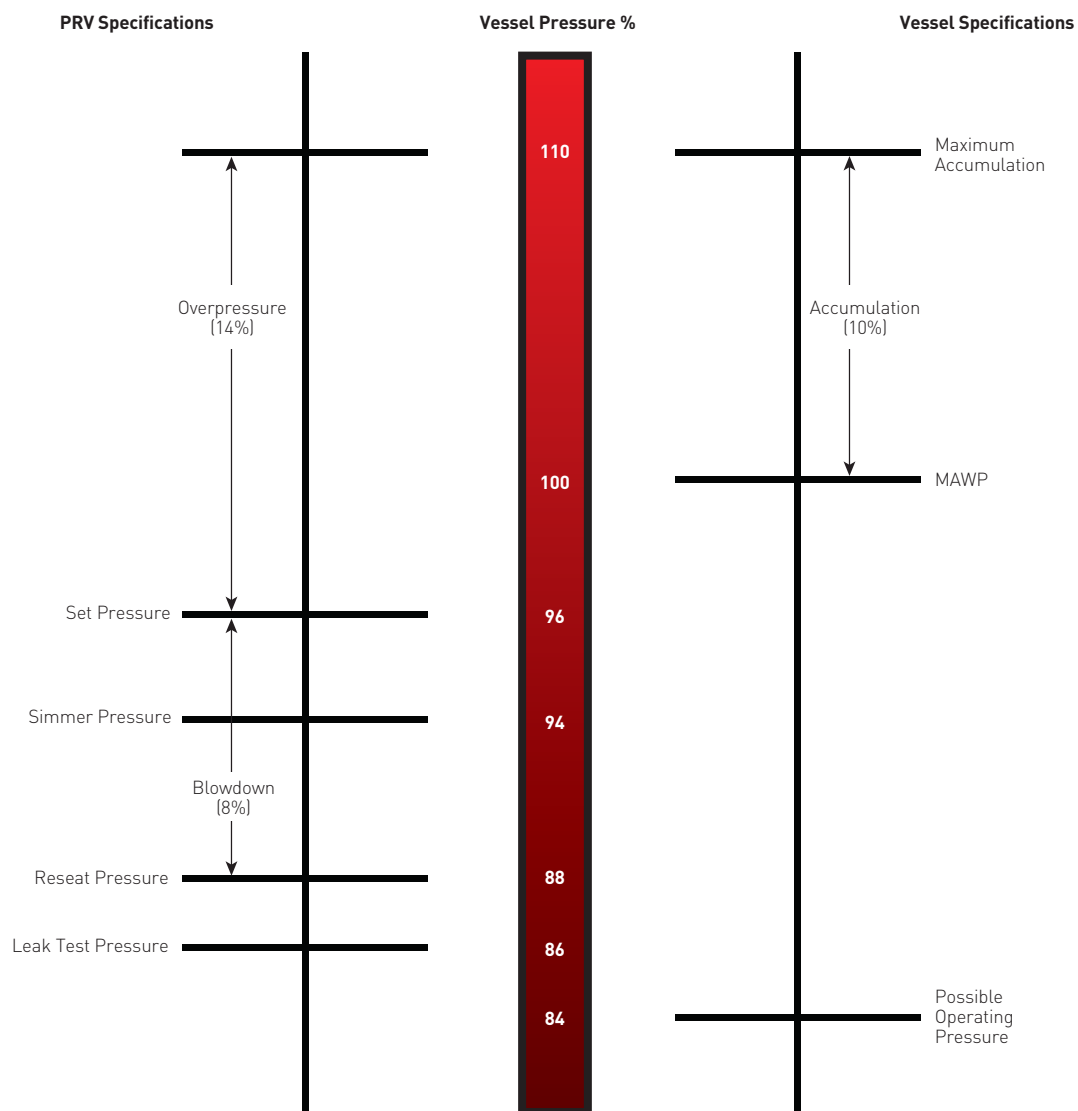
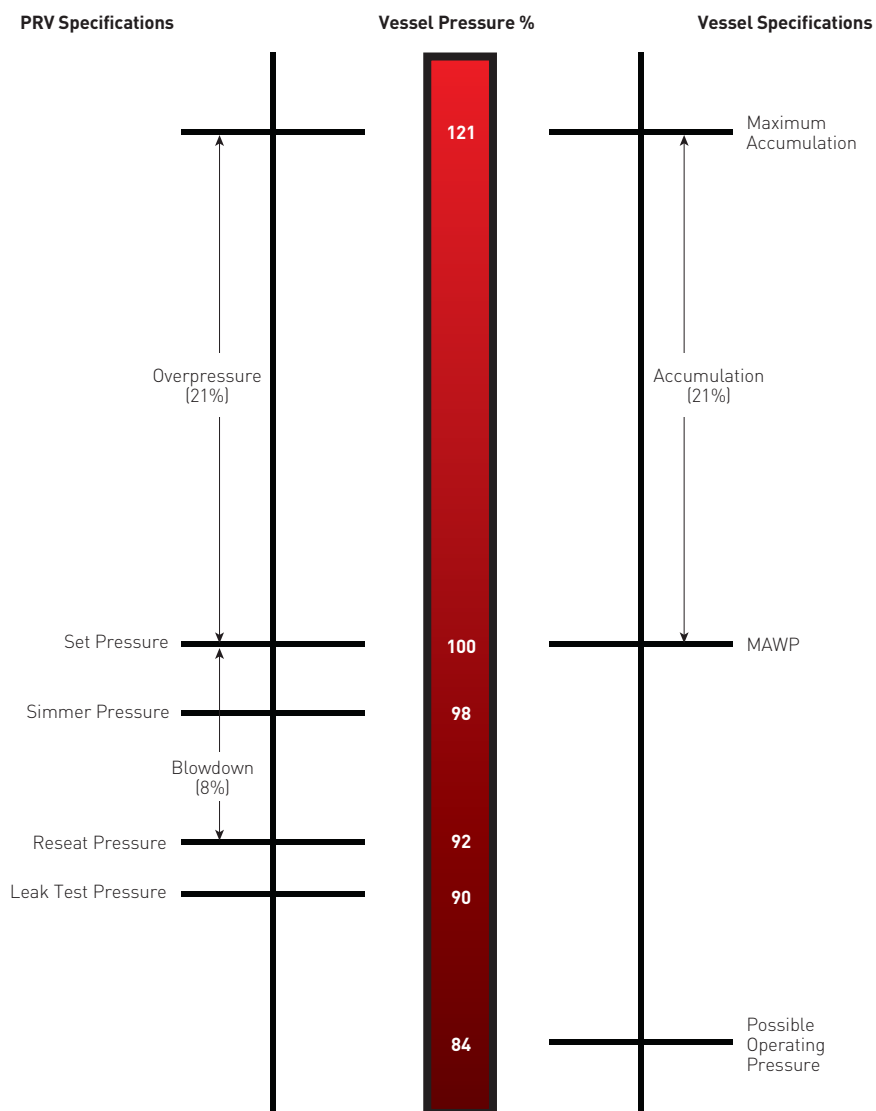


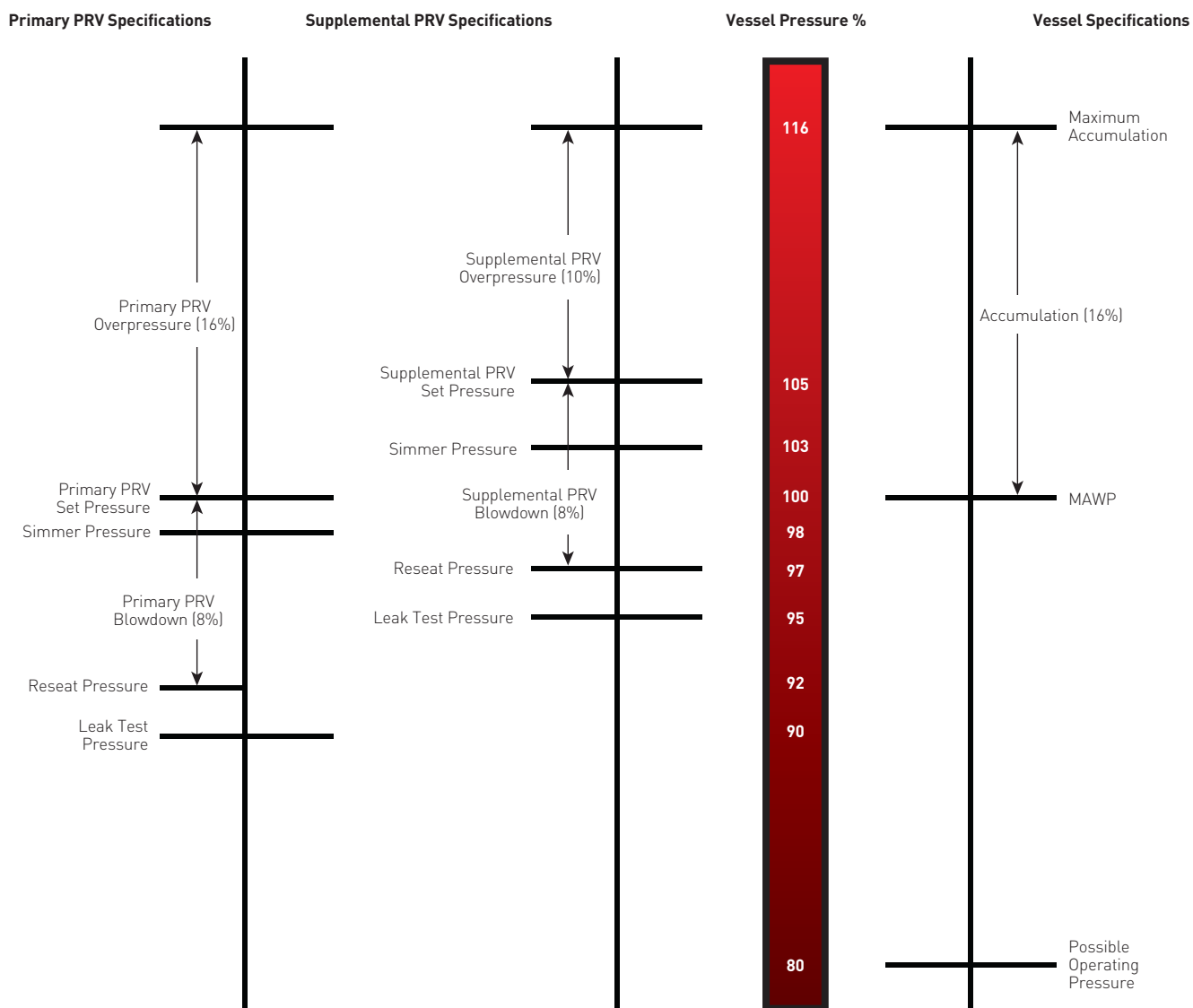
FIGURE 3-9  
 Typical Section VIII Single Device Installation (Fire) - Set at the MAWP of the Vessel



# PRESSURE RELIEF VALVE ENGINEERING HANDBOOK

## CHAPTER 3 - CODES AND STANDARDS

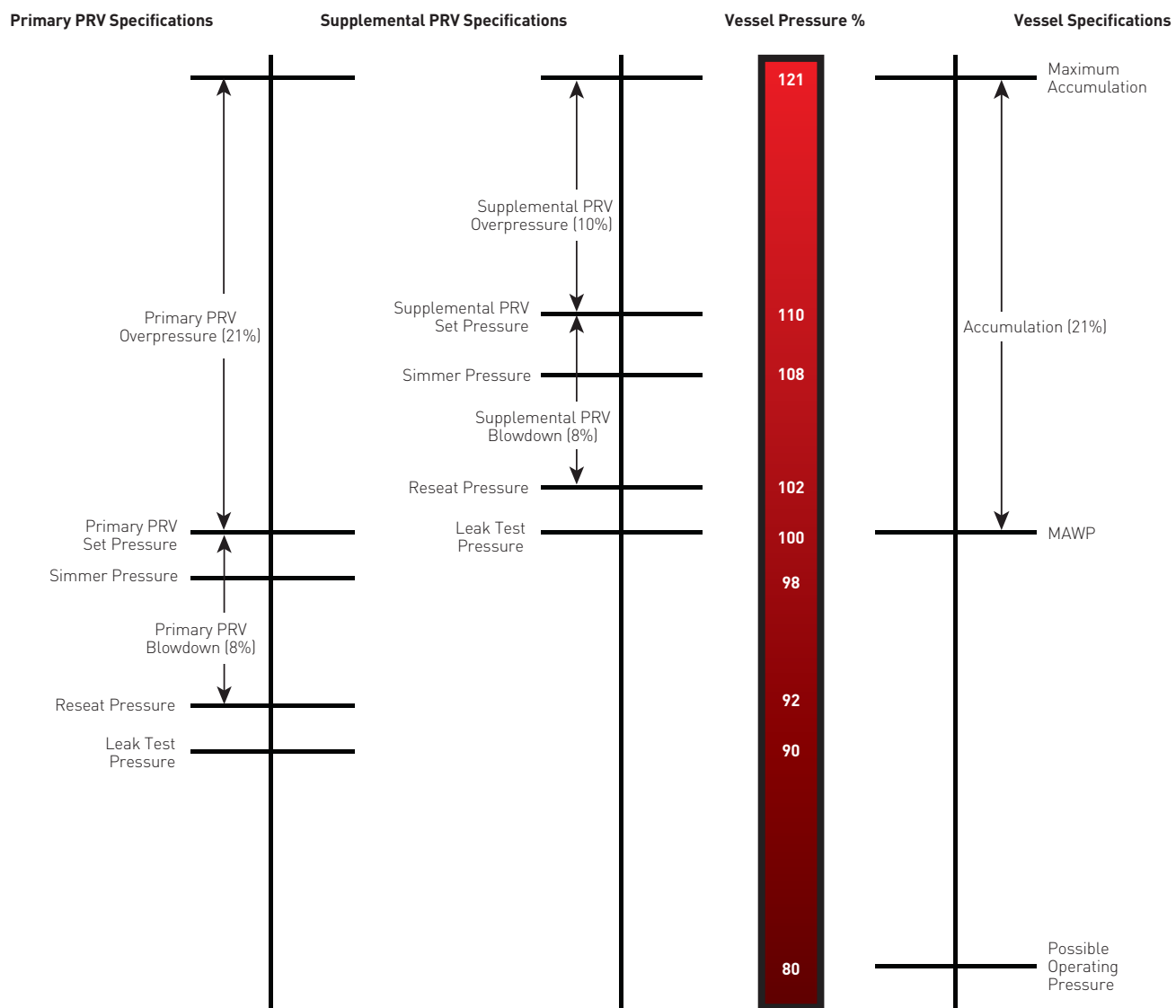
FIGURE 3-10  
Typical Section VIII Multiple Valve (Non-Fire Case) Installation



# PRESSURE RELIEF VALVE ENGINEERING HANDBOOK

## CHAPTER 3 - CODES AND STANDARDS

FIGURE 3-11  
Typical Section VIII Multiple Valve (Fire Case) Installation



### Acceptable Designs

As with ASME Section I, reclosing direct acting spring loaded and reclosing self-actuated pilot operated pressure relief valves can be used for Section VIII vessel protection. Unlike Section I, this part of the Code allows the use of non-reclosing devices such as rupture disks, non-closing direct acting spring loaded valves, and pin devices where the pin holds the pressure containing component closed. A combination of a non-reclosing device mounted in series with a reclosing device can also be an acceptable relieving system. There is also a choice to use simple openings that flow or vent away excessive pressure.

### Allowable Vessel Accumulation

There are different levels of accumulation that are permissible for a Section VIII vessel. When the source of overpressure is not being generated by an external fire and there is one pressure relieving device to be used, the vessel is allowed to experience an accumulation in pressure, during an upset condition, up to 10% over the maximum allowable working pressure (MAWP). Most users desire the highest possible set pressure to avoid unwanted PRV cycles. When a single pressure relieving device is used, the maximum set or burst pressure allowed is equal to the MAWP. In this case, the value of the vessel accumulation and the device's overpressure are the same (see Figure 3-7). Therefore, the design of a pressure relief valve must allow adequate lift to obtain the needed capacity within 10% overpressure. Chapter 4 of the handbook will discuss how the design of a Section VIII valve provides this needed lift with minimal overpressure.

The Code does allow this pressure relief device to be set below the MAWP. When the device is set to open below the MAWP, it may be sized using the overpressure (the difference between the set or burst pressure and the maximum allowable accumulation) as shown in Figure 3-8. When a pressure vessel can experience an external fire that would cause an overpressure condition, the Code allows for a maximum accumulation of 21%. The rule is the same as the non-fire condition, in that the maximum set or burst pressure for a single device installation cannot be higher than the MAWP of the vessel. If a pressure relief valve is selected, it typically will have the same operational characteristics as the one selected for a non-fire relieving case. An overpressure of 21% can be used to size this valve. See Figure 3-9.

There is no mandate in Section VIII that requires the use of multiple relieving devices. However, in some applications it may be that the required capacity to be relieved is too much for a single relieving device. If more than one device is needed, the accumulation, for a non-fire generated overpressure scenario, is to not exceed 16% above the MAWP. This additional accumulation will allow for the multiple pressure relief valves to be set at different pressures. As mentioned previously, this staggered set point regime will help to avoid interaction between the multiple PRVs. Similar to Section I, the rules are that a primary PRV can be set no higher than the MAWP of the vessel. Any additional or supplemental PRV can be set above the MAWP, but at a level no higher than 5% above the MAWP. These multi-device rules in Section VIII will oftentimes allow for the operating pressure to remain at the same level as they would be with a single valve installation. Figure 3-10 will illustrate this multiple PRV scenario. There is no requirement that multiple valves be of the same size, although this is often found to be the case in order to best utilize the inventory of spare parts.

When multiple PRVs are required when the relieving case contingency is heat input from an external source, such as a fire, the primary valve can again be set no higher than the MAWP. Any supplemental valve can be set to open at a pressure 10% above the MAWP. The overall vessel accumulation that is allowed by the Code is now 21%. Please note that if there are any non-fire case contingencies that are to be handled with these multiple valves, any supplemental valve set above 105% of the MAWP cannot be counted in the available relieving capacity. Figure 3-11 provides an example of multiple PRVs for fire cases.

### Pressure Relief Valve Certification Requirements

As we learned in the Section I certification discussion, there are capacity certifications required by the Code for specific valve designs or families. These capacity tests are performed on saturated steam, air or another type of gas such as nitrogen for safety and safety relief valve designs used for compressible fluids. If the design is to be used in steam and in any other non-steam vapor/ gas, then at least one capacity test must be done with steam with the remainder of the tests to be performed on the non-steam vapor or gas. Any relief or safety relief valve used for incompressible media must be capacity certified on water. If the safety relief valve is to have certification on both compressible and incompressible media, then individual capacity tests with gas and with liquid are required.

The steam, gas, or liquid capacity tests are performed with 10% or 3 psi (0.207 bar) overpressure in most instances. Using this flowing pressure criteria, the same three capacity tests outlined above for Section I can be incorporated.

- Specific valve design, size and set pressure testing (3 valves minimum).
- Specific valve design and size using the slope method (4 valves minimum).
- Valve design family using the coefficient of discharge method (9 valves minimum).

The same requirement to meet no more than a plus or minus 5% variance in every capacity test is mandated in Section VIII. Once the specific valve design or family testing meets this requirement, then the rated capacity is taken as 90% of the values measured in the capacity testing. It is this rated capacity that is used to size and select valves per the ASME Section VIII procedures in Chapters 5 and 6.



Since non-reclosing devices such as rupture disks are allowed for use in Section VIII, there may be occasion to use these devices upstream of a pressure relief valve. This pairing of two pressure relieving devices may be necessary to protect the valve from the process conditions and is discussed more thoroughly in Chapter 4. The rupture disk will add additional resistance to flow through the PRD installation and there are capacity testing methods in Section VIII to determine what is denoted as the combination factor used in sizing the devices. The non-reclosing device and the PRV combination factor are based upon the capacity testing of specific device designs. The capacity test of the two devices in series will be done at the minimum set or burst pressure of the non-reclosing device. The combination factor is the capacity measured using the two devices in series divided by the capacity measured in testing only the PRV. Two more additional combination tests are then performed and each capacity measured must fall within plus or minus 10% of the average capacity of the three tests used to establish the combination factor. Additional tests can be performed to use larger non-reclosing devices than the one initially tested and for establishing a combination factor for higher set or burst pressures. If there are no combination factors available via actual testing, then the PRV rated capacity is to be reduced by 10% when any non-reclosing device is installed upstream of the valve.

If a non-reclosing device is used on the downstream connection of a PRV, there is no combination flow testing required, nor is there any required reduction in the PRD installation rated capacity. In addition to establishing the rated capacities, the capacity certification test procedure will also require that the PRV blowdown be recorded. As you will learn in Chapter 4, there are designs of safety valves (used for compressible fluids) that have fixed blowdowns and there are designs that have adjustments to alter the blowdown. If the safety valve design has a fixed blowdown, the reseal pressure is simply denoted after testing. If the safety valve design has an adjustable blowdown, then the reseal pressure cannot be any more than 5% or 3 psi (0.207 bar), whichever is greater, below the set pressure. All relief or safety relief valve designs for liquid service have fixed blowdowns and as such, the reseal pressures are simply recorded during these water capacity tests. The Code requires that the manufacturer demonstrate that each individual pressure relief valve or valve design family tested per the above requirements also provide similar operational performance when built on the production line. Therefore, every six years, two production valves are chosen for each individual valve or valve design family for set pressure (see below for requirements), capacity, and blowdown (if applicable) testing. As with the initial certification testing an ASME designated third party, such as the National Board, is present to witness these production valve tests.

**Pressure Relief Valve Design Criteria**

The set pressure tolerance for Section VIII pressure relief valves for steam, gas or liquid service is as follows:

**TABLE 3-2 - ASME SECTION VIII SET PRESSURE TOLERANCE**

Set Pressure psig (barg)	Tolerance (plus or minus) from the set pressure
Less than or equal to 70 (4.82)	2 psi (0.137 bar)
More than 70 (4.82)	3% of the set pressure

Every valve built and assembled for production will be tested using one of the three media listed above to meet this set pressure tolerance. The capacity that is listed on the nameplate will indicate whether steam, gas, or water was used for this test. Actual service conditions, such as a higher than ambient operating or relieving temperature and back pressure on some types of valve designs, may require an adjustment in the test bench setting. In Chapter 4, you will read about closed spring bonnet designs that can confine the high temperature and lower the spring rate. This may require the test bench setting to be higher so the PRV will open at the right pressure in service. You will also learn about constant superimposed back pressure and how this downstream pressure can cause some valve designs to open at a higher in situ pressure. The test bench setting in this case may need to be lowered to compensate. This production shop test bench pressure is called the cold differential test pressure (CDTP) of the PRV.

There is no requirement within ASME Section VIII to test the blowdown for a production PRV. With the Section VIII safety valves that have an adjustable blowdown as described in Chapter 4, the typical reseal pressure will be 7% to 10% below the set pressure. The size and set pressure of the production safety valve will determine the size of the accumulation vessel needed to obtain the lift to check the blowdown. Many manufacturing and assembly facilities do not have the large vessels needed to perform this test. Therefore, many production safety valves have their blowdown adjustments set empirically based upon laboratory type testing of the valve design. These same assembly shop limitations are one reason there is no requirement for a production valve to undergo a capacity test.

After the production PRV has undergone the set pressure testing, the tightness of the seat of the valve is examined. The seat tightness criteria found in Section VIII is API Standard 527, which is discussed below, the manufacturer’s published specification, or a mutually agreed criteria between the customer and manufacturer. You should note that the manufacturer’s published specification may or may not meet the API 527 requirements.

The proof tests of the pressure containing components are the same as outlined above in Section I, where each production PRV will have the components either hydrostatically tested at 1.5 times the design of the part or pneumatically tested at 1.25 times the design of the part. This proof test is now required even for non-cast pressure containing parts such as bar stock or forgings where the test pressures could exceed 50% of their allowable stress. A pressure containing part made in a cast or welded form will always be proof tested no matter what its allowable stress may be.

There is no restriction on the type of inlet or outlet connection that can be provided. A Section VIII PRV may have threaded, flanged, socket welded, hubbed, union, tube fitting or other type of connection. The only size limitation is that the inlet of any liquid relief valve be a minimum of ½" (DN 15). Any threaded PRV must have flats to allow a wrench to be used to install the valve without damage or altering the set pressure. Any pressure valves that are used in Section VIII applications, where the service is air, steam or water (when the water temperature is greater than 140°F or 60°C when the PRV is closed) must have a device to check if the trim parts are free to move when the valve is exposed to a minimum of 75% of its set pressure. This device is a lift lever (see Figure 3-3) for a direct spring loaded valve. A pilot operated valve may also use this lift lever accessory but these designs can also incorporate what is called a field test connection, where an external pressure can be supplied to function the valve (see Figure 3-4).

This lift lever or field test requirement can be removed via the use of a code case. Code Case 2203 will allow the end user to install a valve in these three services without the lifting device provided the following is met:

- The user has a documented procedure and implementation program for periodic removal of the PRVs for inspection, testing and repair as necessary.
- The user obtains permission for this deletion from any possible jurisdictional authorities.

### Pressure Relief Valve Installation

Unlike Section I, there are no limits to the maximum length of the inlet piping that can be used to connect the PRV to the vessel. The area of the inlet piping shall at least be equal to that area of the valve inlet. The same area requirement is true for the outlet piping which must meet or exceed the valve outlet size. If there are multiple valves mounted on one connection, then this connection must have an area at least as large as the multiple valve inlet area in total.

The longer the inlet piping from the vessel to the PRV, more resistance to flow will occur due to non-recoverable pressure losses that are primarily caused by friction. Since the Code allows unlimited inlet piping lengths, fittings, and transitions, there is a statement in Section VIII that will tell the designer to check this pressure drop so that it does not reduce the available PRV capacity below the required amount. The Code also points out that the actual functionality of a PRV can be affected by these inlet line pressure losses. There is no limitation in the main body of ASME Section VIII regarding the magnitude of these non-recoverable losses. However, a non-mandatory Appendix M of Section VIII will state a limit of 3% of the set pressure for these losses. These piping loss calculations are to be done using the rated capacity of the PRV.

The same design cautions, without the 3% limitation provided for inlet piping, are also denoted for the outlet piping from a PRV. In Chapter 4, we will go into more details surrounding the proper design of inlet and outlet piping for various types of PRVs.

ASME Section VIII allows the use of inlet block valves (See Figure 3-13) to isolate the PRV, provided there is a management system where closing any particular individual or series of block valves does not reduce the available relieving capacity provided from other on-line pressure relief devices. The non-mandatory appendix M will allow block valves, both upstream and downstream of the PRV, that could provide complete or partial isolation of the required relieving capacity. The purpose of these block valves is solely for the inspection, testing, and repair for the PRV. In this appendix there are specific requirements to be followed:

- Management procedures are in place to ensure there is no unauthorized PRV isolation.
- Block valves are provided with a mechanical locking feature.
- Procedures are in place when the block valve has isolated the PRV that will provide overpressure protection. This may simply be having personnel monitor the vessel pressure at all time with the ability to prevent a continual pressure rise or be able to vent and reduce any pressure in the vessel.
- The block valve can only be closed for the time duration of the inspection, test or repair of the PRV.
- The block valve must be of a full area design so the capacity through the PRV is minimally affected.

It is recommended to install PRVs in an orientation where the moving parts are vertical, primarily so there is no added frictional force that could alter the opening pressure.

When a non-reclosing device such as a rupture disk is installed upstream of a PRV, the Code requires that there be a method to monitor the pressure in the space between the two devices. If pressure were to be trapped between the disk and valve, the disk may not operate properly to provide a full opening for the PRV to deliver the required capacity. A bleed ring is oftentimes used with a pressure indicating device installed in the vent connection to monitor this space.

# PRESSURE RELIEF VALVE ENGINEERING HANDBOOK

## CHAPTER 3 - CODES AND STANDARDS

When a rupture disk is used downstream of a PRV, the space between the devices must be vented or the pressure relief valve should be of a balanced design (see Chapter 4). These rupture disks are usually set to burst close to atmospheric pressure.

### Assemblers

The information presented above for Section I will also apply to Section VIII assembler program.

### Nameplates

All pressure relief valves built in accordance with ASME Section VIII are required to have specific information contained on a nameplate that is attached to the valve. The manufacturer's name along with the assembler's name, if applicable, is to be shown. The rated capacity is to be shown at an overpressure of 10% or 3 psi (0.207 bar) of the set pressure. The unit of capacity will be reflected in mass flow rate of steam, or the volume flow rate of air or water depending upon the media used to calibrate the set pressure of the PRV. Recall that this rated capacity is 90% of that measured during certification testing. The valve model number, set pressure and inlet size are also required fields for the nameplate.

For pilot operated valves, this ASME nameplate is to be affixed to the main valve since this portion of the valve determines the capacity. You can identify a pressure relief valve that has been certified to ASME Section VIII by locating a "UV" marked on the nameplate.

In addition to this nameplate identification, the PRV is required to have all parts used in the adjustment of the set pressure and blowdown, if applicable, to be sealed by the manufacturer or assembler. This seal will carry the identification of which authorized facility built and tested the PRV.

### ASME PTC 25 (2014) - Pressure Relief Devices Performance Test Code

When performing testing to certify a device to the ASME Code, the procedures outlined in this document should be followed. This performance code is presented in three parts with a general section that provides a reference for pressure relief device terminology in part I. The second part provides requirements for the flow capacity testing process. Finally the third part lays out acceptable techniques for observing the proper set pressure and lift of the valve's seat. This last section is also a reference used in the writing of acceptable procedures for the production bench testing or in situ setting of the pressure relief valves.

### ASME B16.34 (2009) - Valves - Flanged, Threaded and Welding End

This standard covers pressure, temperature ratings, dimensions, tolerances, materials, non-destructive examination requirements, and marking for cast and forged valves. This standard is not directly applicable to pressure relief valves but it is often used by manufacturers as good engineering practice.

### ASME B16.5 (2013) - Pipe Flanges and Flanged Fittings

This standard provides allowable materials, pressure/ temperature limits and flange dimensions for standard flange classes. Most flanged ended pressure relief valves will conform to these requirements but it should be noted that there may be other valve components outside of the flanges that determine the overall design pressure for the PRV.

## III. INTERNATIONAL ORGANIZATION FOR STANDARDIZATION (ISO)

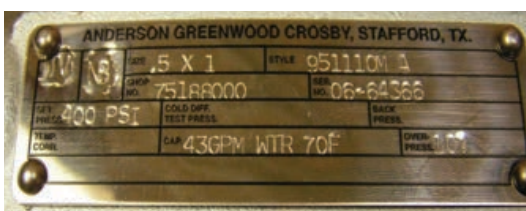
### ISO 4126 - Safety Devices for Protection Against Excessive Pressure

To begin with some background, as part of the standardization process within CEN (Comité Européen de Normalisation), work started back in the early 1990's on preparing product standards to replace those as then used by the various European national bodies.

Working group 10 of the CEN Technical Committee 69 (Industrial Valves) was formed with a view to prepare new EU (or EN) standards for safety devices for protection against excessive pressure. After many years of work within both CEN and ISO (International Organization for Standardization) with joint voting through what is called the Vienna Agreement, the following cooperative EN and ISO standards were prepared. In this chapter, we will refer to these standards as ISO documents to reflect their global reach.

- ISO 4126-1 - Safety Valves (Spring Loaded)
- ISO 4126-2 - Bursting Disc Safety Devices
- ISO 4126-3 - Safety Valves and Bursting Disc Safety Devices in Combination
- ISO 4126-4 - Pilot Operated Safety Valves
- ISO 4126-5 - Controlled Safety Pressure Relief Systems (CSPRS)
- ISO 4126-6 - Application, Selection and Installation of Bursting Disc Safety Devices
- ISO 4126-7 - Common Data
- ISO 4126-9 - Application and Installation of Safety Devices Excluding Stand-Alone Bursting Discs
- ISO 4126-10 - Sizing of Safety Valves for Gas/Liquid Two-Phase Flow

FIGURE 3-12  
Typical ASME Section VIII Nameplate



The above standards, in their entirety, provide related requirements and recommendations for overpressure protection devices that are found in the ASME Boiler and Pressure Vessel Code and API Standards and Recommended Practices. Currently, there is work underway for ISO 4126-11 that will provide standards for the performance testing of various overpressure protection devices.

The intent in this handbook is to draw your attention to some of the requirements found in the ISO standards that may differ from the previous ASME Code discussion. This dialog is not meant to be a complete comparison but a highlight of these items. We will be using the third edition of 4126-1 (July 15, 2013), the second edition of 4126-4 (July 15, 2013), the second edition of 4126-5 (July 12, 2013) and the first edition of 4126-9 (Apr 15, 2008) as references for the information presented.

### Scope

The scope of the ISO 4126 standards begin at a set pressure of 1.45 psig (0.1 barg). This is significantly lower than the scope of ASME Code. There is no distinction in the ISO product standards, such as ISO 4126-1, that change the performance criteria for safety valves used on fired vessels (ASME Section I) versus unfired vessels (ASME Section VIII).

These standards are centered on pressure relief device products and do not address the equipment they are protecting. Therefore, one should reference the applicable design standard for the vessel, pipe, or other pressure containing component to determine requirements such as the allowable accumulation.

### Allowable Vessel Accumulation

The requirement in ISO 4126-9 is that the maximum vessel accumulation is to be defined by the applicable local regulation or directive. If there is a need for multiple pressure relief devices, perhaps due to capacity requirements, then one device must be set at no higher than the maximum allowable pressure set forth by the local regulations. Any additional devices can be set up to a maximum of 5% above this maximum allowable pressure. If local regulations allow, such as a fire contingency, these set pressures may be higher than 105% of the maximum allowable set pressure.

### Acceptable Valve Designs

Depending upon the application, there is the possibility of having more choices in the selection of a pressure relieving device in these ISO standards versus the ASME Code. The requirements for the use of the direct acting and pilot operated PRV designs are outlined in 4126-1 and 4126-4 respectively. For example 4126-1 discusses the use of external power sources that provide additional seat loading to that provided by the spring, and points the user to ISO 4126-5 for the details on using a device called a controlled safety pressure relief system.

### Pressure Relief Valve Certification Requirements

There are capacity certification tests that are similar to ASME on steam, gas and water if applicable. The coefficient of discharge method is used to compare tested flows at 10% or 1.45 psi (0.1 bar) overpressure, whichever is greater, to that of an ideal nozzle. There are multiple tests, anywhere from 4 tests to 9 tests as a minimum, and the ratio from each test must fall within plus or minus 5% of the average. These tests can be performed for a specific valve size or valve design family. Once a coefficient of discharge is established by test, the rated coefficient is reduced by 10% as it is with ASME.

The ISO standard requires that flow testing be demonstrated when a valve is designed to operate when the total back pressure is more than 25% of the set pressure. These tests establish a curve of the flow coefficient of the valve versus the back pressure ratio. This leads to some differences in the way to approach sizing of PRVs under back pressure conditions between API and ISO standards. In API, all corrections ( $K_b$  factor) to the flow due to the back pressure may be from both mechanical and fluid flow effects (see Chapter 7 or 8). In ISO, the back pressure correction factor ( $K_b$ ) includes only the fluid flow effect, and the flow coefficient ( $K_d$ ) includes the correction for the mechanical effect that is discussed in Chapter 4. The sizing procedures in Chapter 5 and 6 will use the API approach for  $K$ ,  $K_d$ , and  $K_b$  factors. However, much of the  $K_b$  data is derived and based upon ISO back pressure testing so the output from the API approach will be the same as the result from the ISO procedures.

There are PRV/non-reclosing combination tests described in ISO 4126-3. There are also functional test requirements where the PRVs must meet the set pressure criteria listed below. In addition, every direct acting or pilot operated valve design must demonstrate a blowdown on steam or gas to fall within 2% to 15% or 4.35 psi (0.3 bar), whichever is greater. There is no distinction between valves with a fixed blowdown or those having an adjustable blowdown. For liquid service, the blowdown must fall between 2.5% to 20% or 8.70 psi (0.6 bar), whichever is greater. In either media, if the PRV is a modulating type design, the minimum blowdown can be less. You may recall that ASME has no minimum or maximum blowdown requirement for fixed blowdown valve designs. There is no requirement in ISO 4126 for any follow-up or renewal capacity testing as there is required for ASME.

**Pressure Relief Valve Design Criteria**

The set pressure tolerance varies little from the ASME Section VIII requirements. For the direct acting and pilot operated PRVs, the range is plus or minus 3% or 2.18 psi (0.15 bar), whichever is greater. There are no significant design criteria differences with the ASME Code.

There is no restriction on the type of end connections that can be specified.

The seat tightness criteria is to be agreed upon between the user and manufacturer.

ISO 4126 requires a proof test that is similar to ASME. No matter what the design of the primary pressure containing parts, this portion of the valve is to be hydrostatically (or pneumatically) tested to 1.5 times its design pressure with duration times that lengthen as the size and design pressures increase. One other difference with ASME is that the secondary pressure containing zone on the discharge side of the valve is also proof tested to 1.5 times the manufacturer's stated maximum back pressure to which the valve is designed. ASME requires a 30 psig (2.06 barg) test pressure for valves discharging into a closed header system, which is normally less than the ISO test requirement.

There is no mandate in the ISO documents for valves to have lifting devices, as shown in Figure 3-3, for any service conditions.

**Pressure Relief Valve Installation**

In ISO 4126-9 there are no limits to the maximum length of the inlet piping that can be used to connect the PRV to the vessel. The area of the inlet piping shall at least be equal to that area of the valve inlet. The same area requirement is true for the outlet piping which must equal or exceed the valve outlet.

The allowance for the use of an isolation valve for a pressure relief device has a significant difference to those requirements in ASME Section VIII Appendix M. The source of the pressure for the vessel being protected must itself be blocked. See Figure 3-13 to help illustrate this point. It should be noted that the vessel may still have an overpressure contingency due to external fire or thermal relief.

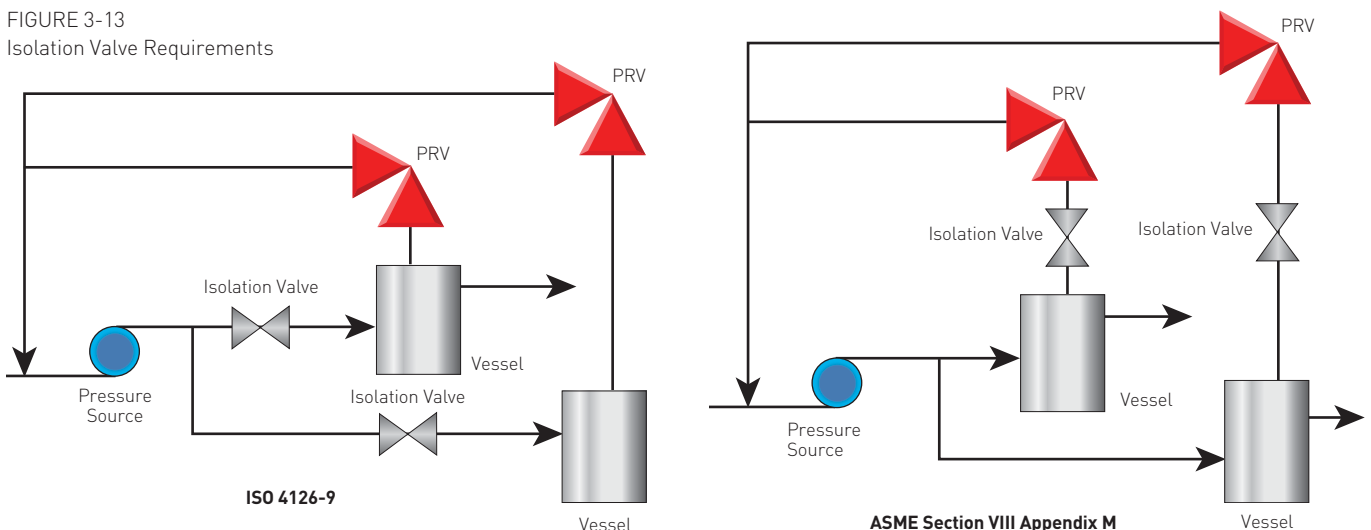
As discussed above, the longer the inlet piping from the vessel to the PRV, the more resistance to flow will occur due to non-recoverable pressure losses that are primarily caused by friction. If there is no local regulation specification being used, ISO 4126-9 will require that the non-recoverable inlet line loss have a maximum value of 3% of the set pressure or 1/3 of the valve's blowdown, whichever may be less.

This inlet loss is to be calculated using the rated capacity of the valve. There is also a requirement that the difference between the valve blowdown and the inlet loss be at least 2%. An exception to these inlet loss limits is allowed using remote sensed pilot operated PRVs. This type of installation is discussed in Chapter 4.

**Nameplates**

There are some additional items of information in the ISO standards versus ASME with regards to identification on the valve nameplates. For example, a direct acting safety valve needs to be marked "ISO 4126-1" and a pilot operated valve marked "4126-4". The derated nozzle coefficient, designated with the applicable fluid (gas, steam or liquid), is to be shown on the nameplate, as well as the actual flow area and minimum lift.

FIGURE 3-13  
 Isolation Valve Requirements



**ISO 23251 (2006) - Petroleum and Natural Gas Industries - Pressure-relieving and Depressuring Systems**

This document provides the process engineer with guidance on how to analyze potential sources of overpressure and to determine the required relieving loads necessary to mitigate the potentially unsafe scenario. There is no minimum pressure in the scope, but most of the information presented will deal with process equipment that have design pressures equal to or above 15 psig (1.03 barg). The document will refer to ISO 4126 and API Recommended Practice 520 part I for the sizing of the pressure relief device orifice. These sizing procedures will be discussed in Chapters 5 and 6. The standard will also provide information on determining the required specifications for the fluid disposal systems downstream of the pressure relieving device. For example, the design basis for determining the relieving loads into this downstream piping are listed in Table 3-3. The definition of a lateral pipe is that section where a single pressure relief device is attached, as shown in Figure 3-14. It should be noted that if the required relieving rate is used for the pressure drop calculation and the requirements should change, then the lateral piping pressure drop should be recalculated. This document will also describe guidelines used to estimate the noise produced by an open PRV vent to atmosphere via a vent stack. This methodology is found in Chapters 5 and 6.

**ISO 28300 (2008) - Petroleum and Natural Gas Industries - Venting of Atmospheric and Low Pressure Storage Tanks**

The scope of this standard is the overpressure and vacuum protection of fixed roof storage tanks that have a design from full vacuum to 15 psig (1.03 barg). This document is very complete in that it encompasses the process of examining what can cause the tank design pressure or vacuum to be exceeded, much like the ISO 23251 standard, all the way to methods of certifying and testing relief devices. There are techniques described in the standard to provide required relieving rates for these pressure and vacuum contingencies and sizing procedures are presented to select the required flow orifices of the relieving devices. The types of devices discussed in the standard are simple open pipe vents, direct acting weight loaded and spring loaded vent valves, and pilot operated pressure relief valves. In addition, there is guidance on the proper installation of these devices.

FIGURE 3-14  
 PRV Discharge Piping Example

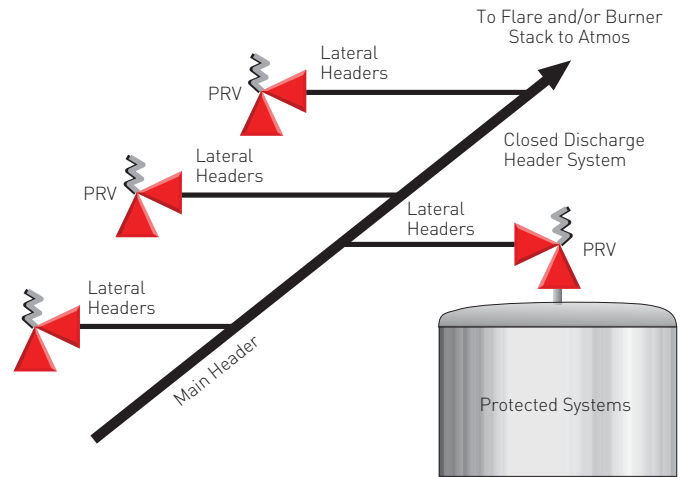


TABLE 3-3 - DESIGN BASIS FOR SIZING DOWNSTREAM PIPING

Pressure Relief Device	Lateral Header	Main Header
Direct Acting Spring Loaded PRV	PRV Rated Capacity	Required Relieving Rate
Pop Action POPRV	PRV Rated Capacity	Required Relieving Rate
Modulating POPRV	Required Relieving Rate	Required Relieving Rate
Non-reclosing Device	Required Relieving Rate	Required Relieving Rate

**IV. EUROPEAN UNION DIRECTIVES**

**Pressure Equipment Directive (PED) 2014/68/EU**

Pressure equipment, which includes pressure relief valves, installed within any country of the European Union (EU) since May 28, 2002, must comply with the Pressure Equipment Directive (PED). Please note that there may also be countries, such as Norway, Switzerland, or Turkey, that are not in the EU, which may require compliance with the PED. The PED applies to any pressure equipment and assembly of pressure equipment with a maximum allowable pressure above (and excluding) 7.25 psig (0.5 barg). However the following applications are excluded from the scope of the PED:

- Pipelines for the conveyance of any fluid to or from an installation starting from and including the last isolation device located within the installation.
- "Simple pressure vessels" covered by what is known as the EU Directive 87/404/EEC. These are basically welded vessels intended to contain air or nitrogen at a gauge pressure greater than 7.25 psig (0.5 barg), not intended for exposure to flame, and having certain characteristics by which the vessel manufacturer is able to certify it as a "Simple Pressure Vessel".
- Items specifically designed for nuclear use, the failure of which may cause an emission of radioactivity.
- Petroleum production well head control equipment including the christmas tree and underground storage facilities.
- Exhausts and inlet silencers.
- Ships, rockets, aircraft and mobile offshore units.

Any other equipment with a maximum allowable pressure higher than 7.25 psig (0.5 barg) falls within the scope of the PED, including the "safety devices," such as the pressure relief valves and rupture disks, protecting this equipment. The PED applies to both power boilers and process pressure and storage vessels.

The certification of equipment in compliance with the PED is through what are called notified bodies, which are approved to carry out these certifications by the European authorities. There are different certification processes available, depending on the type of product and its potential applications. The choice for the type of certification processes lies with the manufacturer, but the level of certification will depend on the intended use of the equipment. Most of the pressure safety devices will have to be certified for the highest level, level IV, except for pressure safety devices that are designed solely for one type of specific equipment, and this equipment itself is in a lower category. Equipment that is certified in compliance with the PED will have to bear the "CE" (Conformite Europeene or European Conformity) mark on its nameplate. However, the CE mark implies also that the equipment is in compliance with any EU directive that may apply to this equipment (like for example the directive on explosive atmosphere to be discussed below). Therefore the CE mark ensures to the user that the equipment complies with any of the applicable EU directives.

It is illegal to affix the CE mark on a product that is outside of the scope (such as a vacuum breather vent) of the PED or any other directive for which the CE marking would show compliance. However, it is possible to affix the CE mark on a product destined to a country outside of the EU, as long as the product itself is within the scope of the PED.

There are some noticeable differences with other codes shown in this handbook. These include the following.

- PED applies to both fired and unfired vessels.
- There is no imposition on the minimum quantity of pressure safety devices that protect a specific type of equipment.
- There is only one vessel accumulation allowed: 10%, with no fixed minimum (i.e. a storage vessel with a maximum allowable pressure of 9 psig (0.62 barg) will have an accumulation of 0.9 psig (62.0 mbarg)). This applies to all cases, including when several pressure safety devices protect the same equipment, but it does not apply to the "fire case." For "fire case" relieving scenarios, the accumulation selected by the equipment designer has to be proven safe for example (there is no loss of containment). Therefore, the "proven safe" level may be lower, higher or equal to 21% that is often used in ASME applications. PED does not address sizing of the pressure relief valve, nor any sort of capacity certification.
- The scope of the PED is for new construction of equipment. This means that repairs are not within the scope of the PED, provided these repairs do not significantly change the characteristics of the product.
- All pressure containing parts have to be pressure tested at 1.43 times the maximum allowable pressure or 1.25 the stress at pressure and temperature, whichever is higher. For pressure relief valves, this means that the outlet zone, outside of the primary pressure containing area of the valve, needs also to be pressure tested.

Parts 1, 2, 4 and 5 of the ISO 4126 standards discussed previously are harmonized to the PED. In the EU, these standards are referred to as EN 4126. This means that they include requirements which address some of the mandatory Essential Safety Requirements (ESR) of the PED. In each of the EN version of these standards, there is an informative annex, Annex ZA, that shows the relationship between clauses of the EN standard and the Essential Safety Requirements of the PED. This is a necessary part of the EN 4126 version but is not required within the ISO 4126 version as the PED is not mandatory outside of the EU. Following these harmonized standards for the design, construction and testing of the pressure relief valve will give presumption of conformity to the PED (to the extent of the scope of the Annex ZA of the standard) but it is not mandatory to follow the EN 4126 standards to comply with the PED. The EN 4126 standards give one way, amongst many, to comply with some of the requirements of the PED. As long as the standards or codes used, such as ASME Section VIII, meet all the requirements of the PED to the satisfaction of the notified body, then valves can be supplied with a CE mark.

### **ATEX Directive 94/9/EC (March 1994, Updated October 2013)**

Since July 1, 2003, the 94/9/EC directive, also known as ATEX 100a, is mandatory for all equipment and protective systems intended for use in potentially explosive atmospheres in the EU. It covers not only electrical equipment but also non-electrical devices such as valves.

Like the PED, ATEX 94/9/EC is a "product oriented" directive and must be used in conjunction with the ATEX "user" Directive 1999/92/EC. This directive helps the user to identify the zones of his facilities in accordance with their risks of having a potentially explosive atmosphere:

- Zone 0 = explosive atmosphere is continuously, or frequently present.
- Zone 1 = explosive atmosphere is likely to occur during normal operation, occasionally.
- Zone 2 = explosive atmosphere is unlikely to occur, and if it does it will be only for a short period.
- Zones 20, 21 and 22 = equivalent as above but for atmospheres laden with dusts like mines, grain silos...

ATEX 94/9/EC defines the Essential Safety Requirements for products into groups and categories:

- Group I = mining applications.
  - Category M1 = suitable for very high risks; Category M2 = suitable for high risks.
- Group II = non-mining applications
  - Category 1 = suitable for very high risks; Category 2 = suitable for high risks; Category 3 = suitable for normal risks.

Putting the 2 directives together:

- Products certified in Category 1 can be used in any zone 0, 1, or 2.
- Products certified in Category 2 can be used in zones 1 or 2. Products certified in Category 3 can be used only in zone 2.
- And similarly with the category M1 for zones 20, 21 or 22 and M2 for 21 or 22.

Like for the PED, certification of a product in accordance to the ATEX 94/9/EC is done by the notified bodies. When a product is certified, its nameplate will bear the CE mark, plus the symbol followed by its group, its category and a "G" if the atmosphere is gas or "D" if the atmosphere can be laden with dust.

## **V. AMERICAN PETROLEUM INSTITUTE (API)**

---

### **API Standard/Recommended Practice 520 - Sizing, Selection and Installation of Pressure Relieving Devices**

This document is divided into two parts. Part I is denoted as a standard and is in its ninth edition that is dated July of 2014, which focuses on the sizing and selection of the devices. Part II is denoted as a recommended practice and is in its fifth edition and is dated August of 2003. Part II provides guidance for the proper installation of the pressure relieving devices.

The scope of API 520 deals with pressure vessels with a MAWP of 15 psig (1.03 barg) and above. The relieving devices discussed are designed for unfired vessels, such as those listed as ASME Section VIII. The power boiler safety valves are not part of the scope.

The ASME Section VIII Code is heavily written around valve design and certification requirements. There is little information on advantages and disadvantages of using one type of pressure relieving device versus another for a particular set of conditions. API 520 part I fills in this type of information and much of the discussion in Chapter 4 of this handbook is taken from this standard.

The sizing techniques listed in API 520 part I ninth edition will be discussed in Chapters 5 and 6.

We will review some of the installation guidelines of part II in later chapters of this handbook.

### **API Standard 521 (Sixth Edition January 2014) - Guide to Pressure Relieving and Depressuring Systems**

This document provides the process engineer with guidance on how to analyze potential sources of overpressure and to determine the required relieving loads necessary to mitigate the potentially unsafe scenario.

There is no minimum pressure in the scope, but most of the information presented will deal with process equipment that have design pressures equal to or above 15 psig (1.03 barg).

The document will refer to API Recommended Practice 520 part I for the sizing of the pressure relief device orifice. These sizing procedures will be discussed in Chapters 5 and 6.

The standard will also provide information on determining the required specifications for the fluid disposal systems downstream of the pressure relieving device. For example, the design basis for determining the relieving loads into this downstream piping are listed in Table 3-3. The definition of a lateral pipe is that section where a single pressure relief device is attached, as shown in Figure 3-14. It should be noted that if the required relieving rate is used for the pressure drop calculation and the requirements should change, then the lateral piping pressure drop should be recalculated.

This document will also describe guidelines used to estimate the noise produced by an open PRV vent to atmosphere via a vent stack. This methodology is found in Chapters 5 and 6.



**API Standard 526 (Sixth Edition April 2009) - Flanged Steel Pressure Relief Valves**

This is really a purchasing standard that is commonly used to specify process industry pressure relief valves. When a company requires a vendor to build a valve to this standard, then known standardized piping envelope dimensions and minimum orifice sizes will be provided. This document is probably best known for the "lettered" orifice designations that are listed, such as a "J", "P", or "T" orifice. Once a letter designation is specified, the manufacturer knows what minimum orifice size is required. The use of these lettered orifices in sizing valves will be discussed in several upcoming sections of the handbook.

API 526 will also list bills of materials that would be valid for certain set pressures and temperatures for different valve designs and sizes. Of course, the process fluid would have to be considered for a final material selection.

The scope of API 526 covers flanged direct acting and pilot operated pressure relief valves. There can be dimensional differences between similar inlet, outlet and orifice sizes of these two different valve designs. Table 4-3 in Chapter 4 will illustrate these differences.

**API Standard 527 (Fourth Edition November 2014) - Seat Tightness of Pressure Relief Valves**

This standard has been and will be mentioned several times in this handbook. It is one method listed in ASME Section VIII to test for seat leakage at certain operating pressure levels. The requirements in this standard are not used for ASME Section I valves. Manufacturers may have alternative methods to check for leakage, so it is advisable to have a common understanding of what the expectations will be with regard to this test. The scope of this document begins with valves that have set pressure of 15 psig (1.03 barg) and above.

In API 527, a typical test set up is shown in Figure 3-15 for closed bonnet valves used in compressible media. If the set pressure of the valve is greater than 50 psig (3.45 barg) then the pressure at the inlet of the valve is brought up to 90% of the set pressure. Depending upon the valve size, this pressure is held anywhere from 1 to 5 minutes. An outlet flange cover or membrane that would rupture if a PRV would accidentally open is then installed. A port from the cover will provide a conduit for any seat leakage to be read one-half inch (13 mm) below the surface of the water in its container.

A metal seated valve is allowed to leak in these operating conditions as shown in Table 3-4. A soft seated valve is required to have no bubble leakage at any set pressure and orifice. Chapter 4 will discuss these two different seat designs.

The leakage rates in Table 3-4 would be similar to 0.60 standard cubic feet (0.017 standard cubic meters) per day for the 40 bubbles per minute rate up to 1.5 standard cubic feet (0.043 standard cubic meters) per day at 100 bubbles per minute.

Prior to testing steam safety valves, any condensate should be removed from its outlet. Once the test pressure is reached, there should be no visible or audible leakage during the one minute hold time.

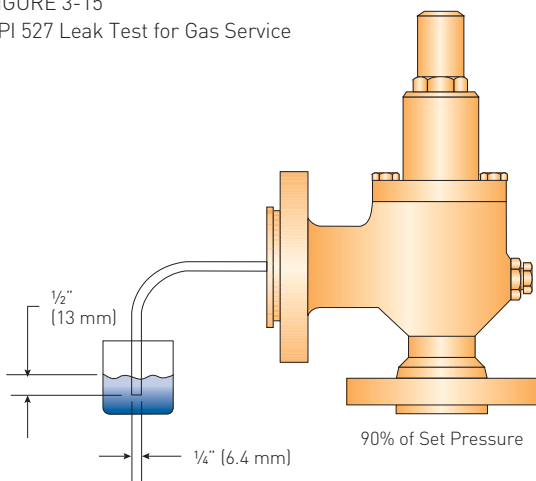
For incompressible service relief valves, water used as the test media is collected after the one minute test. The acceptance criteria for metal seated valves is that there be no more than 0.610 cubic inches or 10 cubic centimeters per hour of leakage for any valve with an inlet less than 1 inch (25 mm). For larger valves, the criteria is that the collected water not exceed 0.610 cubic inches or 10 cubic centimeters per hour per inch of the nominal inlet size. All soft seated valves are to have zero leakage.

**API Standard 2000 (Seventh Edition March 2014) - Venting Atmospheric and Low Pressure Storage Tanks**

This standard is similar to, but not exact as, the ISO 28300 document discussed earlier. These two documents were actually co-branded at one time but are now stand alone.

The scope of API 2000 is the overpressure and vacuum protection of fixed roof storage tanks that have a design from full vacuum to 15 psig (1.03 barg). This document is very complete in that it encompasses the process of examining what can cause the tank design pressure or vacuum to be exceeded, much like the API 521 standard, all the way to methods of certifying and testing relief devices. There are techniques described in the standard to provide required relieving rates for these pressure and vacuum contingencies and sizing procedures are presented to select the required flow orifices of the relieving devices. The types of devices discussed in the standard are simple open pipe vents, direct acting weight loaded and spring loaded vent valves, and pilot operated pressure relief valves. In addition, there is guidance on the proper installation of these devices.

FIGURE 3-15  
API 527 Leak Test for Gas Service



During the process of co-branding the document with ISO, there were some notable changes from earlier editions of API 2000 that are now in the seventh edition. Specifically, the venting loads caused by atmospheric temperature changes that cause vapors in the tank to expand or contract may be quite different than previous editions. In these earlier editions of API 2000 these venting rates were narrowly based upon a service fluid similar to gasoline with limitation on tank size and operating temperatures. Input from European Norms (EN) Standard 14015 that allows for the calculation of thermal venting for any service fluid, tank size or physical location are now reflected in the seventh edition. One of the most notable differences is that there may be a much greater requirement for the inbreathing rates that affect the size of vacuum vents. There is an Annex A in the seventh edition that allows for the calculation of venting requirements per previous editions. The user should be aware of the applicability of using this Annex.

### API Recommended Practice 576 (Third Edition November 2009) - Inspection of Pressure Relieving Devices

This document provides guidance for the inspection and repair of all direct acting (spring and weight) loaded PRVs, and pilot operated PRVs. It will also discuss the inspection of non-reclosing devices. The root causes that affect the performance of the devices is an important section to review.

One common question asked is how often should the pressure relieving device be inspected. API 576 and many other publications may give some maximum intervals which may be as long as ten years. However, there will always be some caveat that these intervals will depend upon the particular service conditions and performance history of the device. These intervals should be adjusted according to this historical record.

### API Standard 620 (Twelfth Edition November 2014) Design and Construction of Large, Welded, Low Pressure Storage Tanks

API 620 deals primarily with carbon steel above ground storage tanks with a gas or vapor space not exceeding 15 psig (1.03 barg). In addition to the carbon steel tank construction practices, there is an Appendix Q that provides design guidance for refrigerated storage tanks requiring more special materials and testing to store liquefied hydrocarbon gases to -270°F (-168°C).

The standard will direct the designer to refer to API 2000 to determine the required relieving capacities and for guidance on device selection. Each tank is required to have pressure relieving devices to flow this required capacity at a pressure no higher than 10% above the tank's design pressure. If there is a fire contingency, then the device can be sized for a tank accumulation of 20% above its design pressure.

The use of vacuum breather vents is called out to provide an incoming source of pressure, typically ambient, be provided so that the tank will not exceed its vacuum design rating.

As with many of the documents, this standard requires that the opening from the tank to the relieving device be at least as large as the nominal pipe size of the device. If there is any discharge piping, it must be at least as large as the area of the valve outlet. Block or isolation valves are allowed but there must be a lock or seal to prevent tampering. If the block valve is closed and the tank is in service, an authorized individual must remain at the installation to monitor the tank pressure.

### API Standard 625 (First Edition August 2010) - Tank Systems for Refrigerated Liquefied Gas Storage

This new standard expands upon the tank construction details outlined in API 620. The API 625 document discusses the entire storage tank system requirements that can be unique to products that require refrigeration temperatures down to and below 40°F (5°C) so that the fluid remains in a liquid state. These products may be liquefied oxygen, nitrogen, natural gas, ethylene, propane, or ammonia. API 625 discusses the possible need for items such as foundation heating, secondary containment areas, insulation spaces, and instrumentation to monitor level, temperature and leakage in order to ensure safe and reliable operation.

**TABLE 3-4 - API 527 LEAKAGE RATE ACCEPTANCE FOR METAL SEATED PRV (GAS SERVICE)**

Set Pressure range	Effective Orifice 0.307 in <sup>2</sup> (198 mm <sup>2</sup> ) or less	Effective Orifice greater than 0.307 in <sup>2</sup> (198 mm <sup>2</sup> )
	leakage in bubbles per minute	leakage in bubbles per minute
Up to 1000 psig (70.0 barg)	40	20
1500 psig (103 barg)	60	30
2000 psig (138 barg)	80	40
2500 psig (172 barg)	100	50
3000 psig (207 barg)	100	60
4000 psig (276 barg)	100	80
6000 psig (414 barg)	100	100

With regards to overpressure and vacuum relief devices, the standard will refer the user to API 2000 which was discussed previously. The standard also points out that there may be local requirements, such as the NFPA documents to be reviewed in the next section, that may be applicable.

One additional requirement for the relief devices in API 625 that is not found in API 2000 is that one spare pressure and vacuum vent valve is required to be mounted on the tank for maintenance needs.

If there is insulation installed via what is called a suspended deck, then the inlet piping of the pressure vent valve mounted to the roof of the tank must run through the deck into the cold space of the tank system. This piping will channel the cold vapors directly to ambient and not allow the low temperature vapor to contact locations of the tank system that may not be designed for exposure to these cold conditions.

### **API Standard 650 (Twelfth Edition March 2013) - Welded Steel Tanks for Oil Storage**

Tanks designed to this standard normally have design pressures very close to atmospheric conditions. The standard will allow the use of a fixed roof, where venting devices are required, or a roof that floats on the inventory of the fluid being stored, which typically will not require relieving devices. There is little information in the standard regarding sizing and selection of relieving devices other than referring the designer to API 2000. One interesting feature of some of the fixed roof designs discussed in the standard is that the attachment of the roof to the walls or shell of the tank can be designed to break or give way at a certain known pressure. This is called a frangible roof joint and this literal damage of the tank can provide adequate opening for emergency fire relief scenarios.

## **VI. NATIONAL FIRE PROTECTION AGENCY (NFPA)**

---

This US-based organization was established over 100 years ago to provide fire prevention guidance via recommended practices, codes, and standards. Since external fire or heat input is often a source of overpressure for vessels and equipment, there are several of these NFPA codes that may be used to size and select pressure relieving devices.

### **NFPA 30 - Flammable and Combustible Liquids Code (2014 Edition)**

This document deals with recommendations for the safe handling and storage of combustible or flammable liquids. These liquids would have a possibility of generating vapors that, when mixed with air, could form a mixture that could ignite. The document will provide guidance for the determination of vapor generation due to external fire to bulk storage tanks. Most of the focus is on low pressure storage tank applications less than 15 psig (1.03 barg). This technique will be discussed in Chapter 5. The sizing of the venting devices is to be in accordance with API 2000 or other locally accepted standards.

### **NFPA 58 - Liquefied Petroleum Gas Code (2014 Edition)**

This code can apply to tanks and piping that are used to provide propane, or similar hydrocarbon having a vapor pressure not exceeding that of propane, to a building as use for fuel gas. The scope also applies to the over-the-road transportation, many marine terminals and onshore pipeline storage tanks that handle this type of liquid petroleum. Marine terminals tied to refineries, petrochemical plants and gas plants are not considered in the scope. The user should refer to the latest edition for other exceptions. These vessels or storage tanks can be refrigerated or non-refrigerated.

Where storage vessels are built for use at 15 psig (1.03 barg) and above, then these vessels are to be designed per ASME Section VIII. These vessels are to have pressure relief valves designed to open on vapor service. Direct acting spring loaded valves are required up to a vessel volume of 40,000 gallons (151 m<sup>3</sup>) of water capacity. Above this volume, either direct acting or pilot operated pressure relief devices are allowed. Storage vessels built for use below 15 psig (1.03 barg) are to be designed per API Standard 620.

There is methodology to determine the required relieving rates for unrefrigerated and refrigerated tanks. In Chapter 5, we will review the fire sizing steps for refrigerated tanks. There are also requirements for the use of thermal relief valves for piping systems.

For non-refrigerated tanks, isolation valves are not allowed unless two or more pressure relief valves are installed on a manifold and only one pressure relief valve can be isolated. The remaining active pressure relief valve must have adequate capacity to meet the requirements.

There are to be no isolation valves on the outlet piping. Any stress that is excessive on the discharge piping is to be mitigated by failure on the discharge side of the pressure relief valve without affecting the PRV performance.

For refrigerated tanks, an isolation valve can be provided but it must be a full bore design that is lockable in the open position. There must be another pressure relief valve on line, either via a three way diverter valve (see Figure 3-5) or via a separate tank penetration.

Pressure relief or vacuum valves on refrigerated tanks must be replaced or tested a minimum of once every five years. The minimum testing interval for non-refrigerated tanks is ten years.

### **NFPA 59A - Standard for the Production, Storage, and Handling of Liquefied Natural Gas (LNG) (2013 Edition)**

As with NFPA 58, this standard also states that the vessel or tank is to be designed per ASME Section VIII or API 620 depending upon the pressure conditions.

Any location that liquefies natural gas, or subsequently stores and vaporizes, is subject to this standard. Portable storage or LNG fueled vehicles or vehicle fueling stations are not in the scope.

As with the other NFPA documents above, there is guidance on how to estimate the required relieving rates for various overpressure or vacuum contingencies. The fire sizing methodology is discussed in Chapter 5. The same isolation valve requirements for refrigerated tanks shown in NFPA 58 is repeated in NFPA 59A. Pressure relief valves on LNG storage tanks or vessels are required to be tested a minimum of every two years.

### **VII. NATIONAL BOARD OF BOILER AND PRESSURE VESSEL INSPECTORS**

---

This organization was established in 1919 to provide standardization in what the organization calls "post-construction" activities such as the installation, repair, and inspection of boilers and pressure vessels. As we noted above, the ASME Codes are used for the new construction of boilers and pressure vessels. Commonly referred to as the "National Board," the organization is primarily comprised of US state or local chief inspectors, Canadian province chief inspectors, insurance companies, end users and original equipment manufacturers.

#### **National Board Inspection Code (NBIC) 23 (December 2013)**

NBIC 23 is provided to give guidance to inspect and repair pressure containing equipment for their safe, continued use. The code is written in three parts, the first dealing with proper installation, the second describes inspection practices and the third provides guidance for the repair and alterations of the equipment.

In the installation portion (part one) of the code, the pressure relief valve items to be reviewed during installation of the equipment are listed for power boilers (such as ASME Section I design), 15 psig (1.03 barg) steam hot water heaters (ASME Section IV), pressure vessels (ASME Section VIII), and piping. In addition to installation guidelines, many of these items are design related and echo the ASME Code requirements we have discussed. For the boilers and heaters, the NBIC code displays proper documentation to be completed prior to commissioning the system. Part two of NBIC 23 will list items necessary to inspect the condition of a pressure relieving device that is currently in use. There is also a checklist of installation items to review such as proper draining of the discharge piping or hazards to personnel from a valve discharge. There are also recommended inspection and testing intervals listed in part two.

The safety valves on power boilers less than 400 psig (27.6 barg) design, hot water boilers, steam heating boilers, and steam service process vessels are recommended to be pressure tested every year. For power boilers with designs greater than 400 psig (27.6 barg) the safety valves are recommended to be pressure tested every three years. Most process vessel inspection frequency recommendations are to be based upon the historical performance due to the numerous unknowns of service and operating conditions. In fact, all of the recommended intervals discussed above and in part two should be evaluated and altered based upon this operating experience. There are items listed in the document to help evaluate the service history. If there are any jurisdictional requirements as to when a pressure relief valve is to be tested, then these outweigh the recommendations in NBIC 23.

The third part of NBIC 23 defines the work process to repair or modify equipment such as pressure relief devices. The document is very similar to certification processes discussed above to manufacture new pressure relieving devices via the ASME Code. In part three, there are instructions to be followed by prospective companies, whether it be an original manufacturer, assembler, repair organization and even operating companies that wish to repair pressure relief devices under the accreditation process of NBIC 23.

The National Board will issue what is called a Certificate of Authorization to a facility once their quality system is reviewed and approved and verification testing is successfully completed. The quality manual will describe in detail the scope of the repair facility's desire and capability of the repair, such as testing media and which ASME Code sections will be used to bring the valve back to as new conditions. This Certificate of Authorization can be for a physical facility, a mobile "in field" repair capability or both. Unlike the assembler certification in ASME Code which authorizes assembly of specific certified devices, the NB repair program (VR) authorizes the certificate holder to repair any manufacturer's certified device if it fits into the repair scope of the certificate holder.

The verification testing includes taking a minimum of two repaired valves for each ASME Code section and subjecting them to capacity and operational testing per the applicable ASME Code requirements. This verification test can be done with any type of acceptable valve design or manufacturer per the ASME Code. Once the prospective repair organization passes this verification testing, then any pressure relief valve built to that part of the ASME Code can be repaired.

Once the approvals are received from the National Board, the repair organization will be allowed to identify repaired valves with the "VR" stamp on the nameplate. NBIC 23 includes required elements that must be on any VR stamped repair tag, which is attached to the valve after repair. The VR nameplate does not replace the original ASME nameplate which must remain attached to the valve. If any information such as set pressure, media, model number and so on, changes during the repair or modification, then this information on the original nameplate should be marked out but should still be legible.

If the original nameplate is lost from the valve to be repaired, then a "VR" nameplate cannot be provided. The exception is that if assurance can be provided, perhaps via a valve serial number provided to the manufacturer, that the valve was originally provided with an ASME Code stamp, then a duplicate nameplate can be attached along with the "VR" nameplate.

All external adjustments are sealed and marked with an identification tag traceable to the repair organization.

The use of the "VR" stamp is valid for three years from approval when another National Board audit and verification test is required.

### **NB-18 Pressure Relief Device Certifications**

The National Board has been designated by the ASME to provide the inspection, review and acceptance of pressure relief devices to meet the various sections of the ASME Code. The NB-18 document lists all of the original manufacturers and their assemblers that are certified to provide new pressure relief devices per the ASME Code. These devices are listed with their applicable ASME Code section, certified capacities and media in which they were tested. This document is available on line at <http://www.nationalboard.org>. The information is generally updated on a monthly basis.

NB-18 also lists those organizations who are certified to repair pressure relieving devices per the NB-23 requirements discussed above.

# PRESSURE RELIEF VALVE ENGINEERING HANDBOOK

## CHAPTER 4 - DESIGN FUNDAMENTALS

---

### THE FOLLOWING DATA IS INCLUDED IN THIS CHAPTER

---

I.	Introduction.....	4.3
II.	Direct Acting Pressure Relief Valves .....	4.3
	Weight Loaded PRV Operation .....	4.3
	Direct Spring Safety Valve Operation - Gas/Vapor Trim Designs .....	4.5
	Direct Spring Relief Valve Operation - Liquid Trim Design .....	4.7
	Direct Spring Safety Relief Valve Operation - Gas and Liquid Trim Design .....	4.8
	Direct Spring Pressure Relief Valve Seat Designs.....	4.8
	Direct Spring Pressure Relief Valve Components .....	4.9
	Direct Spring Pressure Relief Valve - Portable Design .....	4.10
	Inlet Piping Considerations.....	4.11
	Discharge Piping Considerations.....	4.13
	Direct Spring Safety Relief Valve Operation - Balanced Designs .....	4.14
III.	Pilot Operated Pressure Relief Valves.....	4.15
	Snap Action Pilot Design.....	4.17
	Modulating Action Pilot Design .....	4.19
	Pilot Operated Pressure Relief Valve Seat Designs.....	4.22
	Pilot Operated Main Valve Components .....	4.23
	Inlet Piping Considerations.....	4.24
	Discharge Piping Considerations.....	4.25
IV.	Advantages and Limitations of Valve Types.....	4.27

# PRESSURE RELIEF VALVE ENGINEERING HANDBOOK

## CHAPTER 4 - DESIGN FUNDAMENTALS

---

### THE FOLLOWING FIGURES ARE INCLUDED IN THIS CHAPTER

---

Figure 4-1	Weight Loaded Pressure Relief Valve.....	4.3
Figure 4-2	Direct Acting Pressure/Vacuum Vent.....	4.4
Figure 4-3	Typical Weight Loaded Pressure/Vacuum Vent Capacity vs Overpressure Characteristic.....	4.4
Figure 4-4	Emergency Pressure Relief Device.....	4.5
Figure 4-5	Generic Direct Spring PRV Trim.....	4.5
Figure 4-6	Section VIII Safety Valve Trim.....	4.6
Figure 4-7	Typical Section VIII Safety Valve Lift Characteristics.....	4.6
Figure 4-8	Section I Design Safety Valve Trim.....	4.7
Figure 4-9	Effect of Nozzle Ring for ASME Section I Design Safety Valve.....	4.7
Figure 4-10	Effect of Guide Ring for ASME Section I Design Safety Valve.....	4.7
Figure 4-11	Relief Valve Trim.....	4.8
Figure 4-12	Typical Relief Valve Lift Characteristic.....	4.8
Figure 4-13	Metal Seated Direct Spring PRV.....	4.9
Figure 4-14	API 526 Direct Spring PRV.....	4.9
Figure 4-15	Open Bonnet Direct Spring PRV.....	4.10
Figure 4-16	Threaded Portable Direct Spring PRV.....	4.11
Figure 4-17	Flanged Portable Direct Spring PRV.....	4.11
Figure 4-18	Inlet Piping Effects on Direct Acting PRV.....	4.11
Figure 4-19	Tailpipe Discharge Piping.....	4.12
Figure 4-20	Closed Header System Discharge Piping.....	4.12
Figure 4-21	Effect of Built-up Back Pressure on Conventional PRV.....	4.13
Figure 4-22	Superimposed Back Pressure in a Conventional Direct Spring Loaded PRV.....	4.13
Figure 4-23	Balanced Bellows Direct Spring PRV.....	4.14
Figure 4-24	Balanced Piston Direct Spring PRV.....	4.15
Figure 4-25	Piston Type Pilot Operated PRV.....	4.15
Figure 4-26	Diaphragm Type Pilot Operated PRV.....	4.16
Figure 4-27	Height Comparison of Direct Spring vs Pilot Operated PRV.....	4.17
Figure 4-28	Pop Action Pilot Operated PRV (closed).....	4.18
Figure 4-29	Pop Action Pilot Operated PRV (open).....	4.18
Figure 4-30	Main Valve Lift vs Set Pressure for Pop Action Pilot Operated PRV.....	4.19
Figure 4-31	Modulating Action Pilot Operated PRV (closed).....	4.20
Figure 4-32	Modulating Action Pilot Operated PRV (open).....	4.21
Figure 4-33	Modulating Action Pilot Operated PRV (open and in full lift).....	4.21
Figure 4-34	Main Valve Lift vs Set Pressure for Modulating Action Pilot Operated PRV.....	4.22
Figure 4-35	Piston Type Main Valve Components.....	4.22
Figure 4-36	Remote Sense Pilot Operated PRV.....	4.23
Figure 4-37	Balanced Modulating Pilot Operated PRV.....	4.23
Figure 4-38	Sonic to Subsonic Flow Transition.....	4.25
Figure 4-39	Superimposed Back Pressure in Piston Type Pilot Operated PRV.....	4.25
Figure 4.40	Backflow Preventer.....	4.25

### THE FOLLOWING TABLES ARE INCLUDED IN THIS CHAPTER

---

Table 4-1	Full Bore vs API Orifices.....	4.16
Table 4-2	Weight Comparisons.....	4.16
Table 4-3	API 526 Direct Spring vs Pilot Operated PRV Dimensions.....	4.24

### I. INTRODUCTION

A pressure relief valve (PRV) is a safety device designed to protect a pressurized vessel, system or piping during an overpressure event. An overpressure event refers to any condition which would cause pressure in a vessel, system, pipe or storage tank to increase beyond the specified design pressure or maximum allowable working pressure (MAWP). Since pressure relief valves are safety devices, there are many codes and standards written to control their design and application. (See Chapter 3.) The purpose of this discussion is to familiarize you with the various parameters involved in the design of a pressure relief valve. Many electronic, pneumatic and hydraulic systems exist today to control fluid system variables, such as pressure, temperature and flow. Each of these systems requires a power source of some type, such as electricity or compressed air, in order to operate. A pressure relief valve must be capable of operating at all times, especially during a period of power failure when system controls are non-functional. The sole source of power for the pressure relief valve, therefore, is the process fluid. Once a condition occurs that causes the pressure in a system or vessel to increase to a dangerous level, the pressure relief valve may be the only device remaining to prevent a catastrophic failure. The pressure relief valve must open at a predetermined set pressure, flow a rated capacity at a specified overpressure, and close when the system pressure has returned to a safe level. Pressure relief valves must be designed with materials compatible with many process fluids from simple air and water to the most corrosive media. They must also be designed to operate in a consistently smooth and stable manner on a variety of fluids and fluid phases. These design parameters lead to the wide array of Emerson products available in the market today and provide the challenge for future product development.

### II. DIRECT ACTING PRESSURE RELIEF VALVES

The oldest and most commonly used type of PRV is the direct acting type. They are designated as direct acting because the force element keeping the valve closed is either a weight or a spring or a combination of both. The process to be relieved acts directly on the seat pallet or disc, which is held closed by the weight or spring opposing the lifting force that is generated by the process pressure. There are two kinds of direct acting pressure relief valves, weight loaded and spring loaded.

#### Weight Loaded PRV Operation

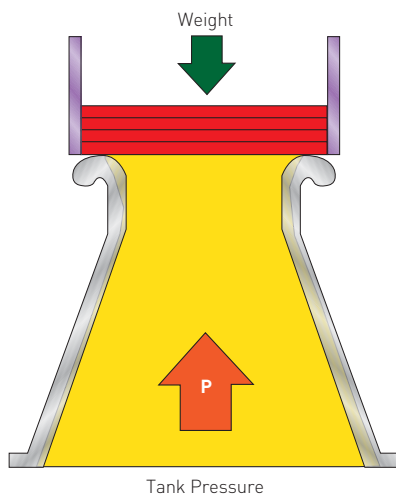
The weight loaded PRV is one of the simplest and least complex type of PRV. It is a direct acting valve because the weight of the valve's internal moving parts (see Figure 4-1) keep the valve closed until the tank pressure equals this weight. These valves are often called weighted pallet valves because the set pressure can be varied by adding or removing weights on the top of a trim part called a pallet (see Figure 4-2).

These weighted pallet valves are also known as conservation vents or breather vents. This is because one of the primary uses of these devices is to protect low pressure storage tanks that have fixed roofs. These storage tanks are often designed per API Standard 620 or 650 and have very low design pressures in the inches of water column (mbar) range. Since the design pressures are very low, the simple pumping in of product or increased ambient temperatures can raise vapor pressures in the tank and cause these weight loaded valves to "breathe" and discharge the pressure. The sizing and selection of these weight loaded valves is often done per API 2000 or ISO 28300 which will be discussed in Chapters 5 and 6.

One of the advantages of the weighted pallet valve is its ability to be set to open as low as 0.5 ounces per square inch (0.865 inches of water column). This is only  $\frac{1}{32}$  of a pound per square inch or just over 2 mbar. In order to mount these devices to the storage tank, the nozzle, pallet and weights are contained within a body. The material of construction for the body and the internals can be of many types to provide compatibility with the contents of the storage tank. In addition to ductile iron, aluminum, carbon and stainless steel, these devices can be manufactured from fiberglass reinforced plastic components. The simple nature of the device lends itself to being a good economic choice in many applications.

In Figure 4-2 you will note another pallet denoted for vacuum protection. Recall that the common application for these devices is for low design pressure storage tanks and as such can be subject to collapsing inward due to vacuum conditions. These vacuum conditions can be caused simply by pumping out product or a lowering of ambient temperature to cause condensation of the vapor in the tank. The weight loaded vacuum pallet will provide a route for ambient pressure to break the vacuum and prevent implosion of the tank.

FIGURE 4-1  
Weight Loaded Pressure Relief Valve





# PRESSURE RELIEF VALVE ENGINEERING HANDBOOK

## CHAPTER 4 - DESIGN FUNDAMENTALS

A weight loaded vent valve normally uses a soft resilient film material, such as PTFE, to provide the seal between the pallet and the nozzle. This helps to prevent sticking between these components. When properly maintained, this film seat design will provide an acceptable seal up to 75% of the valve's set pressure. API 2000 and ISO 28300 provides the acceptance criteria for seat tightness at 75% of the set pressure. This allowable leakage can range from 0.5 SCFH (0.014 Nm<sup>3</sup>/hr) of air for 6 inch (150 mm) and smaller valves to 5 SCFH (0.142 Nm<sup>3</sup>/hr) of air for valve sizes up to 12 inches (300 mm). Many of these valves with the PTFE film seal are designed to provide a maximum leak rate of 1 SCFH (0.028 Nm<sup>3</sup>/hr) of air at 90% of the set pressure.

The storage tanks that are being protected by these devices are oftentimes designed to hold large volumes of fluids and thus can require a pressure or vacuum relieving device which needs to be able to deliver high venting capacities. Therefore, the size of these devices can be as big as 12" (300 mm) for their tank connection size. Since the force of the weights keeping the seat or pallet closed must be higher than the tank pressure multiplied by the exposed seat area, there are physical limitations to the maximum set pressure that can be provided. For example, the 12" (300 mm) weighted pallet valve may have a seat or nozzle area of approximately 90 in<sup>2</sup> (581 cm<sup>2</sup>) that is exposed to the process. In order to obtain a set pressure of 1 psig (69 mbar), 90 lb (41 kg) of weight is required. Adding these weights to the body and trim of the valve can then require the entire valve to physically weigh several hundred pounds which can be difficult to support on a thin roof design of an atmospheric storage tank. Therefore, the typical maximum set pressure for these devices will range from 1 to 2 psig (69 to 138 mbar) depending upon the size and design.

One operational characteristic of these weighted pallet valves is the amount of overpressure required to obtain lift of the pallet and weights, and provide the required capacity through the valve. There is little available energy at these low set pressures to provide this lift so additional storage tank pressure above the set pressure is needed. For example, it is not uncommon for a valve that is set in the inches of water or millibar range to require almost 100% or more overpressure to obtain its full lift (see Figure 4-3). The same characteristic is also found during the opening operation of the vacuum pallet.

The high overpressure that may be required for the pressure or the vacuum required capacity will often necessitate the set pressure or vacuum setting to be closer to atmospheric conditions. This can cause continual emissions to atmosphere or contaminate the contents of the storage tank with the ambient inbreathing from the vacuum pallet. Therefore, either the operating conditions must be lowered below the setting of the weighted pallet valve or the tank must be built with a higher design rating. In either case, the efficient use of the tank is compromised.

In many storage tank applications there is a requirement for a pressure relief valve to be provided for what is called emergency overpressure relief. This overpressure capacity contingency is often caused by an external source of heat such as a fire that boils the liquid contents. This particular contingency may require higher relieving rates than can be obtained with the weighted pallet valve.

Figure 4-2  
Direct Acting Pressure/Vacuum Vent

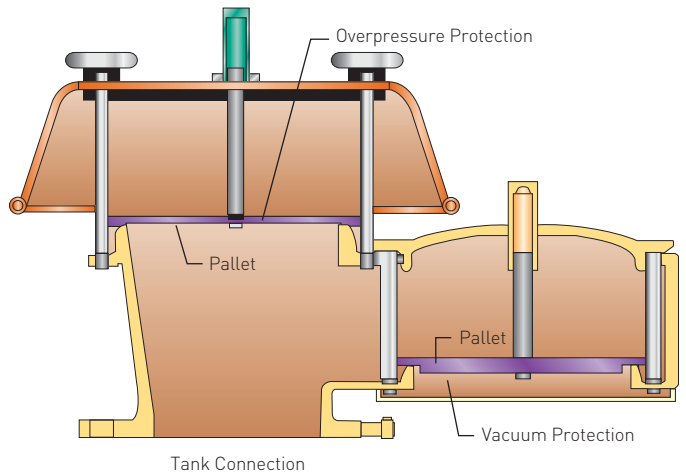
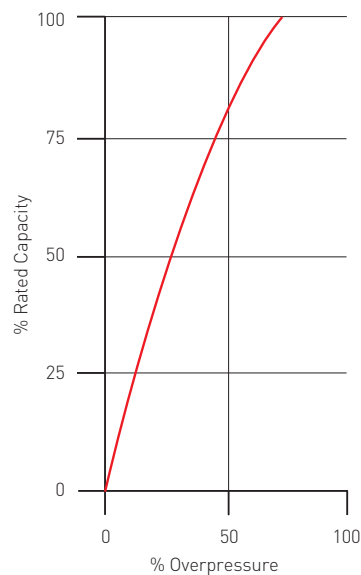


FIGURE 4-3  
Typical Weight Loaded Pressure/Vacuum Vent Capacity vs Overpressure Characteristic



In these situations, an emergency pressure relief valve can be considered to provide additional capacity. These devices are simply tank hatches, also called "manways," that normally have hinged covers. The covers have a calibrated weight, moment arm and possibly a counterweight to provide the required set pressure. See Figure 4-4. These emergency relief devices are set at higher pressures than the weighted pallet valves. If called upon to open and relieve pressure, they are designed to stay open until manually closed.

**Direct Spring Safety Valve Operation - Gas/Vapor Trim Designs**

Since the weighted pallet valve has limited set pressures of no more than one or two pounds per square inch (69 to 138 mbar), a compressed spring that opposes the force provided by the process pressure is the most widely used method of increasing the set pressure. An advantage of using a compressed spring is the wide number of applications for this design from approximately 5 psig (0.345 barg) to over 20,000 psig (1380 barg) set pressures.

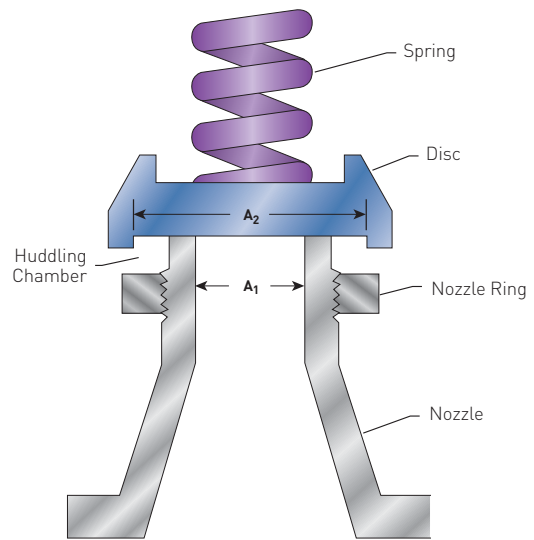
Since we are using what is called a direct acting spring loaded valve at or above 15 psig (1.03 barg), this design is more often than not subject to the requirements of the ASME Boiler and Pressure Vessel Code. As we learned in Chapter 3, among the Code requirements are values of maximum accumulation that vessels can see during an overpressure event. For ASME Section I vessels, the maximum accumulation can be from 3% to 6% over the MAWP and for ASME Section VIII vessels, the maximum accumulation can be from 10% to 21% over the MAWP. Since it is desirable to not open pressure relief valves unless absolutely necessary, most users will set them to open at the highest pressure allowed by the relevant section of the Code. This set pressure is typically at or near the MAWP of the vessel. Therefore, the design of an ASME Code certified valve must provide lifting characteristics to prevent the allowable accumulation pressure from being exceeded. In other words, these direct spring valves must have sufficient lift with overpressures as low as 3% for Section I vessels and 10% for Section VIII vessels. For a weighted pallet valve, the pressure force required to lift the pallet must exceed only the weight of the pallet. This weight remains constant, regardless of the lift. In a spring loaded valve, the pressure force required to initially lift the seat is determined by the pre-loaded spring compression. As the spring is being compressed more during lift, the upward force required to obtain lift increases. The overpressure provides some of this additional upward force but it is not enough to obtain the needed lift within Code mandated accumulation pressures.

Figure 4-5 is a simple sketch showing the seat, also called a disc, held in the closed position by the spring. When system pressure reaches the desired opening pressure, the force of the pressure acting over Area  $A_1$  equals the force of the spring, and the disc will lift and allow fluid to flow out through the valve. In order to obtain the lift within the Code required accumulated pressure, most direct acting spring valves have a secondary control chamber to enhance lift. This secondary chamber is better known as the huddling chamber. The geometry of this huddling chamber helps to determine whether the direct spring pressure relief valve is suitable for use in compressible, non-compressible or the possible mix of either of these fluid states.

FIGURE 4-4  
 Emergency Pressure Relief Device



FIGURE 4-5  
 Generic Direct Spring PRV Trim



For direct spring pressure relief valves designed to work exclusively on compressible media such as gases or steam, a typical trim is illustrated in Figure 4-6. This type of valve is called a safety valve. As the disc begins to lift, fluid enters the huddling chamber exposing a larger area (this is illustrated as  $A_2$  in Figure 4-5) to the gas or vapor pressure. This causes an incremental change in force, sometimes called the expansive force, which overcompensates for the increase in the downward spring force and allows the valve to open at a rapid rate. This effect allows the valve to achieve maximum lift and capacity within overpressures that will let this valve be set at the MAWP and prohibit the accumulation pressure from exceeding Code mandated levels.

Because of the larger disc area  $A_2$  (Figure 4-5) exposed to the system pressure after the valve achieves lift, the valve will not close until system pressure has been reduced to some level below the set pressure. The difference between the set pressure and the closing point, or reseal pressure, is called blowdown and is usually expressed as a percentage of set pressure. For example, if the valve is set at 100 psig (6.90 barg) and the reseal pressure is 92 psig (6.34 barg), then the blowdown for the valve is 8%.

Some valves built for ASME Section VIII have non-adjustable, or fixed, blowdowns. The valve will reseal depending upon the spring being used and the tolerance of the moving parts. The blowdown for this type of valve could be 20% or more.

It may not be desirable to use a safety valve with a non-adjustable blowdown design when the operating pressure is close to the set pressure or if there is a need to minimize the amount of service fluid being released during an opening cycle. In these cases a manufacturer can provide a design with an adjustable blowdown by adding a part called a nozzle ring. This ring is threaded around the outside diameter of the nozzle and can be adjusted up or down. See Figure 4-5.

The position of the nozzle ring controls the restriction to flow between the disc and ring in the huddling chamber when the disc just begins to lift at set pressure. The smaller the clearance between these two parts, the higher the expansive force that builds up to minimize the spread between the simmer pressure and the set pressure. This higher expansive force provides a rapid audible pop on compressible service but the force holding the disc open is high and there is more pressure reduction (i.e. longer blowdown) required in the vessel to reseal the valve. Therefore the nozzle ring can be lowered thus opening the distance between the disc and ring. This increases the difference between the simmer pressure and the set pressure, but shortens the blowdown.

For these gas/vapor safety valves, the typical performance curve is shown in Figure 4-7.

These safety valves achieve over 50% of their required lift at the set pressure and use the overpressure to open fully when the process pressure is 10% above the set pressure of the valve. For a single safety valve that is set to open at the vessel MAWP for an ASME Section VIII non-fire case overpressure contingency, if the valve is sized properly, the vessel pressure will not exceed 10% accumulation and the valve will reseal with a blowdown of 7% to 10%. Direct acting spring loaded safety valves that are built per API Standard 526 normally perform as described above.

As mentioned in Chapter 3, safety valves that are designed for use in ASME Section I need to have adequate lifting characteristics at lower overpressures than ASME Section VIII safety valve designs. It is common to have only 3% overpressure available to obtain full lift for a Section I safety valve. This more stringent performance requirement necessitates the addition of a second control ring located on the outside of the valve guide. This is called the guide ring, and this additional part permits more precise "tuning" of the huddling chamber. See Figure 4-8.

FIGURE 4-6  
 Section VIII Design Safety Valve Trim

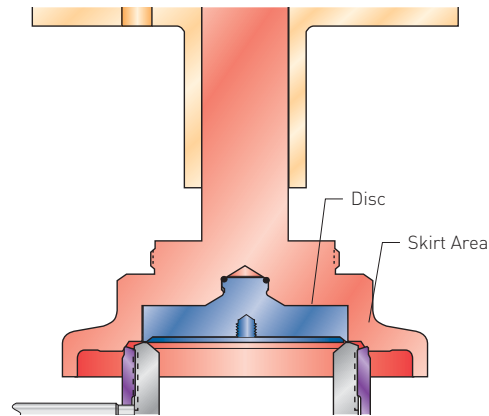
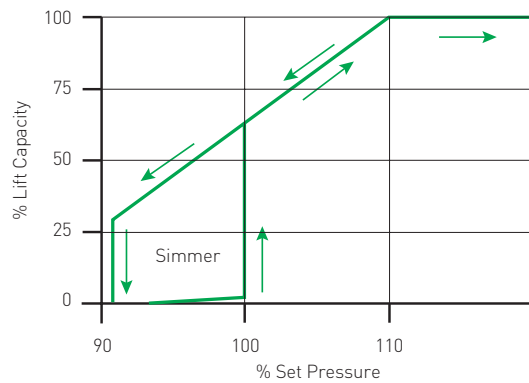


FIGURE 4-7  
 Typical Section VIII Design Safety Valve Lift Characteristics



Operation of the two ring valve is very similar to that of the single ring design. When inlet pressure exceeds the force exerted by the valve spring, the disc moves off the nozzle and the escaping steam builds the upward force via the nozzle ring that is directed to the disc face to minimize the spread between simmer and set pressure (see Figure 4-9). The position of the nozzle ring determines the difference between simmer pressure and set pressure. As with the ASME Section VIII safety valve design, the higher the nozzle ring position, the less simmer or leakage occurs prior to lifting the disc.

As the lift continues, the steam starts to impinge on the guide ring as shown in Figure 4-10 to provide even more lifting force so that adequate lift is achieved with 3% overpressure. The guide ring position determines the blowdown setting. The lower the guide ring position, the higher the opening force delivered by the flowing steam. This causes an increase in the blowdown. In order to decrease the blowdown, the guide ring is raised.

Recall that the requirement during provisional certification for a Section I safety valve is to demonstrate a blowdown of no more than 4%. This valve performance criteria, along with the minimal overpressure, necessitates the two ring trim design.

**Direct Spring Relief Valve Operation - Liquid Trim Design**

For incompressible fluids, there is no expansive force available to assist in the lifting of a relief valve seat. ASME Section VIII has the same maximum accumulation pressure requirement for liquid service as there is for gas service, typically 10% over the MAWP, which cannot be exceeded during a relieving event. A direct acting liquid relief valve initially uses reactive forces and then momentum forces to obtain its lift within the Code requirements.

Figure 4-11 shows the trim parts for a direct spring relief valve design for liquid service. If you compare the shape of the skirt area of the disc holder in this figure to the skirt area of the disc holder in Figure 4-6 you will notice a contour difference. This different geometry in the liquid relief valve skirt will allow the liquid to be directed downward as the flow begins. The upward reaction force on the disc increases slowly at minimal overpressure.

As the flow of the liquid stream increases with the lift, the increased velocity head provides the momentum force to be additive with the reactive force to open the valve disc substantially so that a surge, or gush, of liquid flow is observed at the outlet of the valve. This flow profile happens with less than 10% overpressure and full lift, and rated capacity is obtained with a maximum of 10% overpressure. See Figure 4-12.

FIGURE 4-8  
 Section I Design Safety Valve Trim

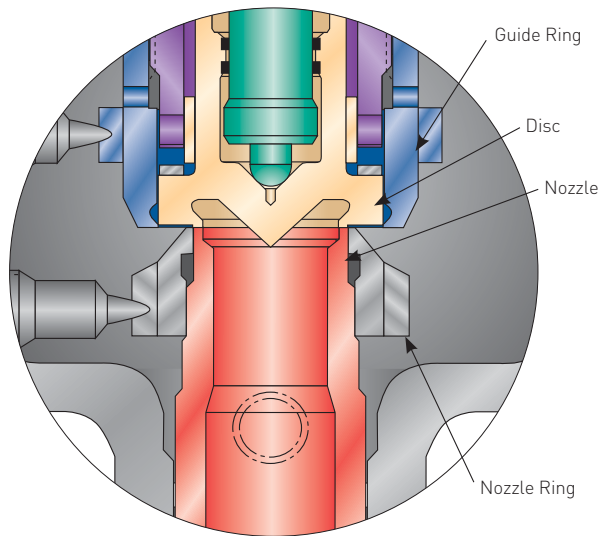


FIGURE 4-9  
 Effect of Nozzle Ring for ASME Section I Design Safety Valve

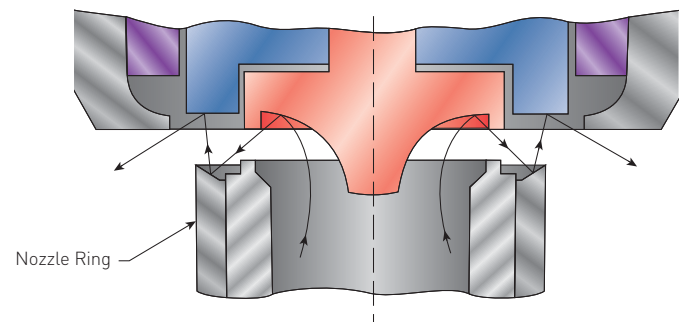
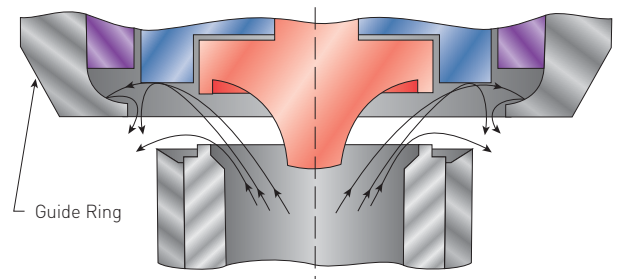


FIGURE 4-10  
 Effect of Guide Ring for ASME Section I Design Safety Valve



These liquid trim relief valves also have a blowdown ring. The ring helps to provide the upward reactive force to assist opening, however the position of the ring is not used to determine when the valve will reset. These relief valves have a fixed blowdown that will allow the device to reclose at approximately 10% to 15% below set pressure. Prior to 1985, the ASME Section VIII code did not require certified liquid capacities at 10% overpressure. Many manufacturers provided PRVs with trim designs similar to that shown in Figure 4-6 for use in incompressible medias. This trim design often required up to 25% overpressure for the valve to obtain full lift because the lower reactive forces generated by the trim design. It was also noted that the loss of liquid velocity during opening might cause an undesirable fluttering or oscillating action.

**Direct Spring Safety Relief Valve Operation - Gas and Liquid Trim Design**

There may be installations where the service fluid may be either compressible, incompressible or a combination of phases when the pressure relief valve is called upon to operate. For instance, there may be multiple overpressure contingencies to consider for a pressure relief valve where the valve may see liquid in one case and a gas in another. Another example is that there might also be a fluid that can be in a liquid state under pressure and while it is relieving, the fluid may transition to some quality of vapor causing a multi-phase relieving state. There are direct acting valves available that have been certified to meet ASME Section VIII requirements for gas or liquid. This is normally accomplished using the liquid trim design (Figure 4-11) which will provide an adequate huddling chamber to obtain rated capacity by 10% overpressure on vapor service. This trim geometry will provide a stable lifting characteristic on gas or liquid or mixed phase fluids. One item to note is that the blowdown is fixed and could be as long as 20% for this gas/liquid trim design when discharging a compressible fluid.

**Direct Spring Pressure Relief Valve Seat Designs**

Since the normal operation condition for a pressure relief valve is closed, one important consideration is the valve’s ability to maintain a tight seal. The disc to nozzle interface is most commonly metal to metal as shown in Figure 4-13.

The advantage of the metal to metal seal is a wide range of chemical and temperature compatibility with the process fluid. This is especially important for the high pressure and temperature steam drum and superheater safety valves found in Section I applications.

The surface of the disc and nozzle that come in contact with each other are polished to an exact finish. Another term used for this seat and nozzle surface treatment is called “lapping.” The valve part alignment and the selection of the materials of construction all play a key role to meet industry seat leakage standards such as API 527 which is often used for process PRVs built per ASME Section VIII.

API Standard 527 requires the valve seat to be tested for tightness normally at 90% of the set pressure. The API standard acceptance criteria allows minor bubble leakage at this operating pressure but this allowed leakage is many orders of magnitude more stringent than required for other types of valves. A diligent maintenance schedule must be carried out in the field to maintain the seating integrity of the valve, especially on a system where the pressure relief valve may have cycled.

FIGURE 4-11  
 Relief Valve Trim

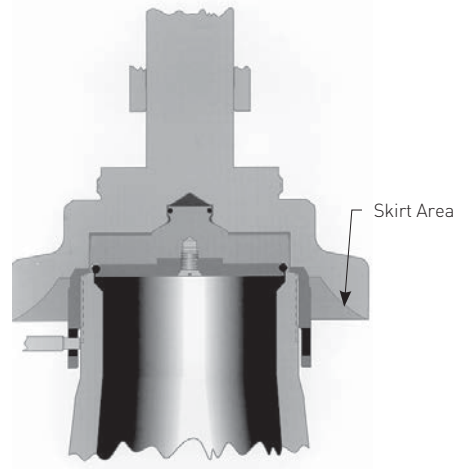
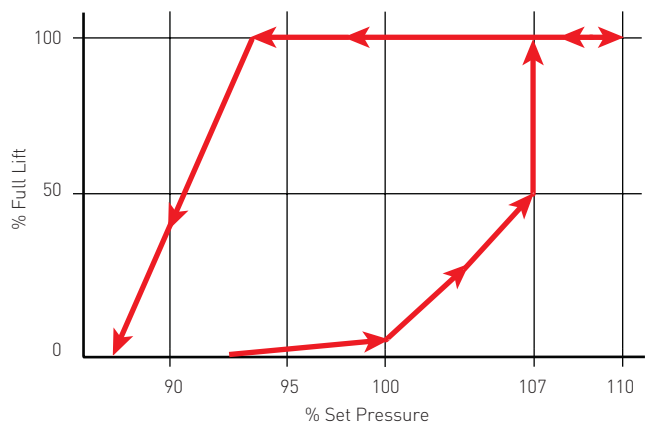


FIGURE 4-12  
 Typical Relief Valve Lift Characteristic



Since these metal to metal seated valves are prone to some leakage, the use of a rupture disc upstream and in series with the direct acting valve can provide a zero leak point during normal system operating conditions. Recall from Chapter 3 that there is a requirement in ASME Section VIII that mandates a capacity reduction of 10% of the certified valve capacity if the specific rupture disc has not been capacity certified in combination with the specific pressure relief valve. The rupture disc should also be non-fragmenting to avoid parts of the disc impinging components of the pressure relief valve. As noted in Chapter 3, the pressure in the space between the rupture disc and the pressure relief valve should be monitored so that a burst or leaking rupture disc can be identified and replaced.

The ASME Section I valve metal seat design can often allow for a slightly higher operating pressure than 90% of set pressure. The leak test for these valves is performed with steam and no visible leakage of the steam is permitted.

When process conditions warrant, a soft seat, such as an elastomer or plastic material might be substituted for the metal to metal design. The advantage of such a seat is that API 527 does not allow any leakage at 90% of the valve's set pressure. In fact, some soft seated valve designs allow the operating pressure to go as high as 95% of the set point. These soft seats are easily replaceable and require no special lapping during maintenance.

Care must be taken in selecting the proper soft seat compound based upon the pressure, temperature and process fluid conditions that these soft seat materials may see.

**Direct Spring Pressure Relief Valve Components**

Figure 4-14 shows additional trim components for a process pressure relief valve that often falls under the API 526 standard purchasing specification for flanged steel valves.

These valves have what is called a full nozzle. A full nozzle has the advantage in that the process fluid will not be in contact with the valve body when the valve is in the closed position. You will note that the inlet of the full nozzle itself forms the raised face or ring joint portion of the inlet flange connection. The full nozzle is threaded into the valve body and can be removed for maintenance. It is the bore of the nozzle that will determine the actual flow area for most of these API 526 standard lettered orifice sizes.

FIGURE 4-13  
 Metal Seated Direct Spring PRV

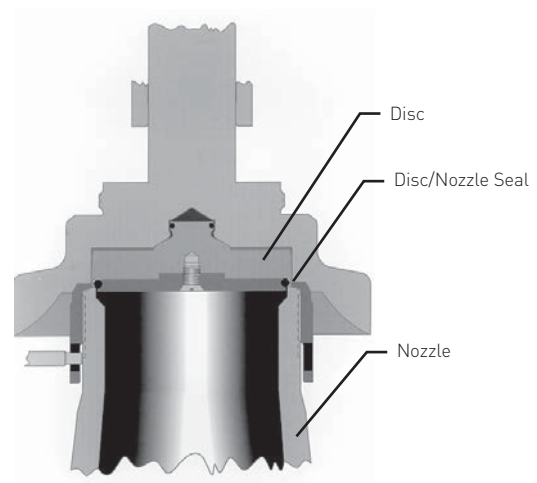
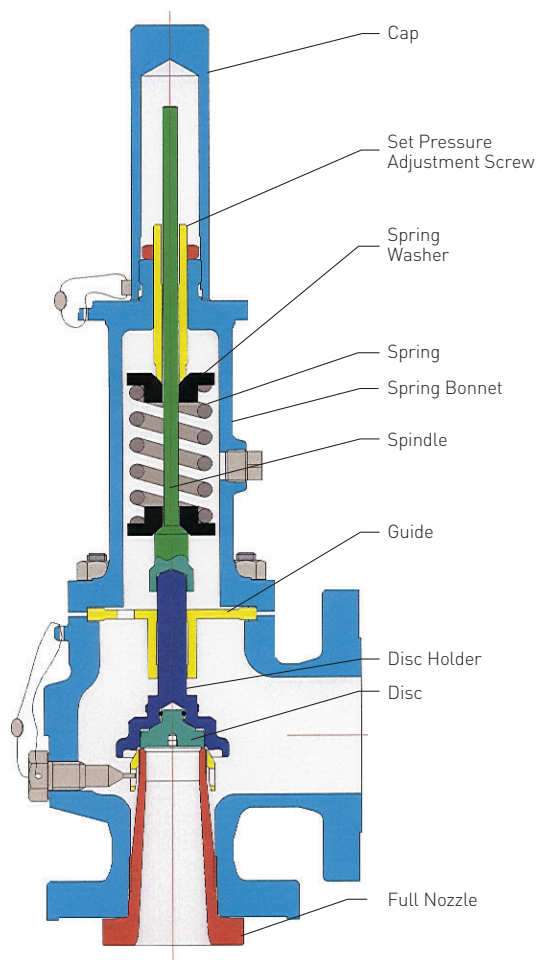


FIGURE 4-14  
 API 526 Direct Spring PRV



The disc, whether it is metal to metal or soft seated, is contained by the disc holder. The disc is often held in place via a loss thread type connection or retention clip. When the disc is contained in the holder with either method, the disc has some articulation of movement to help reseal properly to the nozzle.

The guide is used just as its name implies, it allows for the proper opening and closing of the disc holder. The tolerance and the materials of construction in the design of the guide and disc holder are vital to providing repeatable performance. The guide and disc holder typically are made from different materials, that in turn have different hardness characteristics, in order to prevent a seizing or galling of parts during normal expected valve operation.

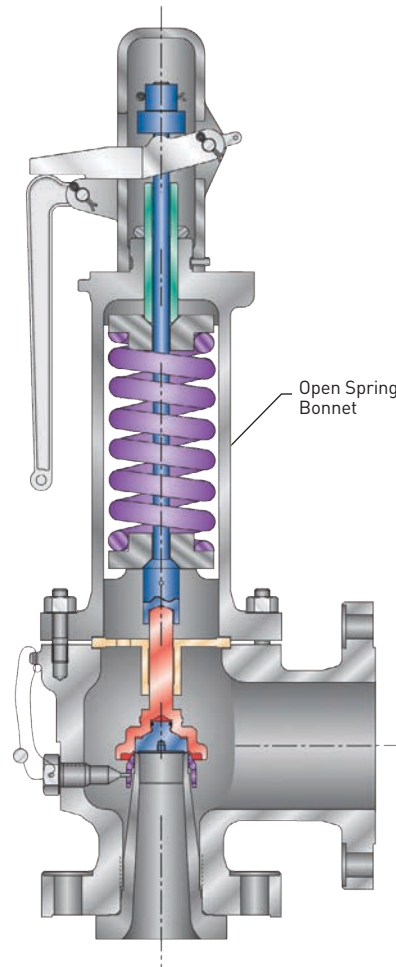
The spindle provides a bearing point for the spring compression to press the disc holder against the nozzle. As with the disc and its holder, the interface between the spindle and the top of the disc holder help to align the disc to properly allow the disc to contact the nozzle during repeated operations or cycles.

The set pressure adjusting screw contacts the top spring washer to raise or lower the set point of the valve by adding or reducing the amount of spring compression that is imparted to the spindle/disc holder. This adjustment screw is located under a cap. The cap can be lock wired after being attached to the bonnet to provide administrative controls prior to altering the set pressure of the valve. The cap can be screwed or bolted onto the bonnet.

One note about the spring bonnet is that it may be either a closed or open design. The bonnet shown in Figure 4-14 illustrates a cutaway view of a closed bonnet. The closed bonnet provides the feature of isolating the spring from ambient conditions. One item of note for the valve in Figure 4-14 is that when the valve is called upon to relieve pressure, the service fluid will not only be routed out the discharge flange but it will also expose all of the internal trim parts to the process. When the service fluid is exposed to all of the PRV trim parts it can be called a conventional direct spring operated pressure relief valve. The closed bonnet will contain this service fluid and prevent exposing the environment and personnel to a possible hazardous condition.

One other type of conventional direct spring PRV uses what is called an open spring bonnet as shown in Figure 4-15. This type of bonnet configuration is most commonly found on boiler safety valves built to meet ASME Section I but they can also be used in process applications. An open spring bonnet can also be called a yoke. Exposing the spring to the ambient will allow for the radiation of heat from the spring. Various spring materials at elevated operating temperatures can allow a shift of the in situ set pressure to a value that is lower than the test bench set pressure, which is done at ambient temperature. The open bonnet helps to cool the spring to minimize the effect on the set pressure caused by the high temperature service fluid. The disadvantage of the open bonnet PRV is that the service fluid will not only exhaust out the discharge of the valve but also out of its open bonnet. These open bonnet valves should be located away from areas where personnel could be present. For open bonnet valves that may be located outside, there are weather hoods available to protect the exposed spring.

FIGURE 4-15  
Open Bonnet Direct Spring PRV



**Direct Spring Pressure Relief Valve - Portable Design**

Pressure relief valves that are designed to meet the ASME Section VIII requirements do not necessarily have to meet the API 526 purchasing standard. There are many other types of connections, other than flanged, that are available for use. For example, many of the valves that are less than 2" (50 mm) in size for their inlet are often provided with threaded connections. A common term for these valve types is "portable valves" because of their small physical size and weight. See Figure 4-16.

These portable valves may also be adapted to weld on inlet and outlet flanges (see Figure 4-17) to meet a particular piping specification. One should note that the dimensions, materials, inlet/outlet sizes and orifice designation normally do not necessarily meet the API 526 purchasing standard.

There is no requirement in ASME Section VIII that specifies a particular type of connection. In addition to the threaded connections, you can find these process valves with socket weld, hubbed, union, tubing or several other types of fittings for the inlet and/or outlet of the valve.

**Inlet Piping Considerations**

The proper design of inlet piping to pressure relief valves is extremely important. It is not unusual to find these process pressure relief valves mounted away from the equipment to be protected in order to be more accessible, to be closer to the effluent disposal system or for maintenance purposes. There may be a considerable length of inlet piping with bends that may cause significant non-recoverable (loss due primarily by friction caused by flow within the piping) pressure loss during the valve's operation.

Depending upon the size, geometry, and inside surface condition of the inlet piping, this pressure loss may be large (10%, 20% or even 30% of the set pressure) or small (less than 5% of the set pressure). API recommended practice 520 part II and the non-mandatory appendix M of ASME Section VIII guide the engineer to design for a maximum inlet pressure loss of only 3% of the valve set pressure. The recommended practice will tell the user to calculate these losses using the rated capacity for the device.

The importance of this inlet piping evaluation is illustrated in Figure 4-18 which shows that when a direct acting PRV is closed, the pressure throughout the system being protected is essentially the same. The inlet piping configuration will not change the set pressure of the PRV.

However, when the valve opens, the frictional losses created by the inlet pipe will cause a difference in the pressure from the system ( $P_s$ ) and the valve inlet ( $P_v$ ). A direct acting PRV will reseal when the  $P_v$  value reaches the blowdown for the valve. It is important that the non-recoverable inlet line losses be less than the blowdown of the valve so there is a higher probability of a stable lift and a single reclosure cycle. Non-recoverable inlet losses in excess of the blowdown can be a cause of valve chatter or rapid cycling.

FIGURE 4-16  
 Threaded Portable Direct Spring PRV

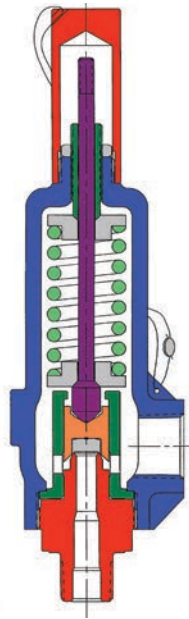


FIGURE 4-17  
 Flanged Portable Direct Spring PRV

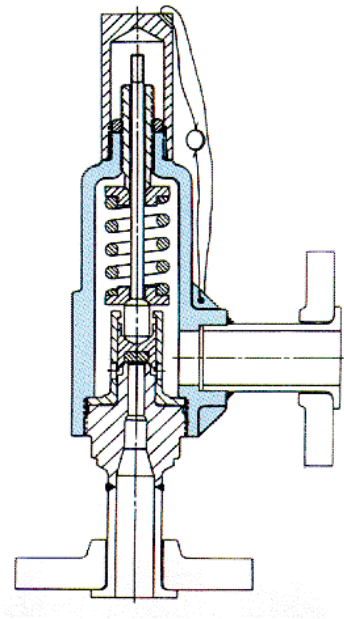
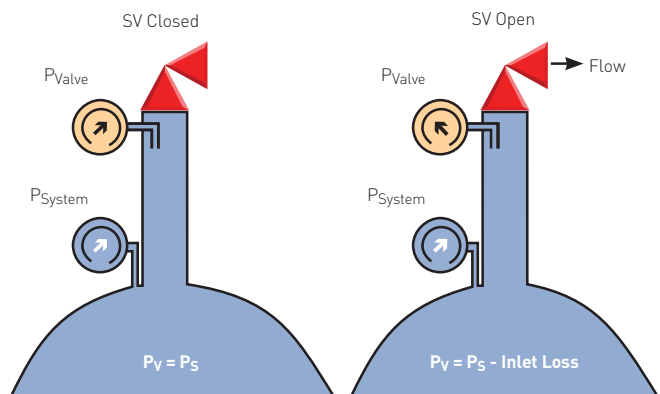


FIGURE 4-18  
 Inlet Piping Effects on Direct Acting PRV





To provide a clearer picture of this valve chatter possibility, consider the following example using Figure 4-18.

Set Pressure = 100 psig (6.90 barg)

Reseat pressure = 93 psig (6.41 barg) [7% blowdown]

Non-recoverable inlet loss at rated flow = 3 psig (0.207 barg) (3% of the set pressure)

After the valve opens, it will reseat when  $P_v$  is equal to 93 psig (6.41 barg). The pressure in the system,  $P_s$ , will approximately be 93 psig + 3 psig or 96 psig (6.41 barg + 0.207 barg or 6.62 barg). The valve closes and the system pressure stabilizes at 96 psig (6.62 barg). The valve remains closed at this point.

Consider a second scenario where the same valve is installed where the inlet loss is increased to 10 psig (0.690 barg). In this case, when the valve reseats at 93 psig (6.41 barg) the pressure in the system is approximately 93 + 10 psig or 103 psig (6.41 + 0.690 barg or 7.10 barg). Immediately upon reseating, the valve must open because the system pressure is above its set pressure. This is what can cause rapid cycling or chatter.

This unstable operation reduces capacity and is destructive to the valve internals and possibly to the piping supporting the valve. Even the best of tolerances between the guide and disc holder and even the best materials of construction may not prevent galling on these parts.

As mentioned previously, for a compressible fluid, the single blowdown ring API 526 direct acting safety valve will typically have a 7% to 10% blowdown. For compressible services, the recommendation in API 520 part II and ASME Section VIII of limiting the non-recoverable line losses to 3% provides for a needed spread from the blowdown to reduce the possibility of valve chatter. As pointed out in Chapter Three, ISO 4126-9 provides similar cautions with regards to the maximum allowable pressure loss in the inlet line.

It is a requirement in both Section I and Section VIII that the area of the tank connection, fitting, and all inlet piping be equal to or greater than the area of the PRV inlet.

You will recall that there is a blowdown requirement to be a maximum of 4% when applying for ASME Section I certification. Because of this, there are strict guidelines in Section I for boiler safety valve installations regarding the length of the inlet piping, and to avoid sharp transitions on the connection from the steam drum to the inlet piping. The inlet loss should be an absolute minimum for these valves. See Figure 3-6 for more details relating to recommended piping practices for Section I. On existing installations, the corrective action to alleviate valve instability due to excessive inlet losses can be somewhat limited for direct acting spring loaded PRVs. For a process pressure relief valve, if the length or fitting restrictions of the inlet pipe to the PRV cause losses that exceed 3%, then it is recommended to increase the line size of the pipe or straighten the pipe. Another possibility is to change the blowdown setting of the PRV. When the blowdown is greater than the non-recoverable losses, the chance of valve instability decreases. Unfortunately, it is sometimes not economically or technically feasible to do a dynamic blowdown test, as described in Chapter 2, that is necessary to accurately set the ring in the proper position.

FIGURE 4-19  
 Tailpipe Discharge Piping

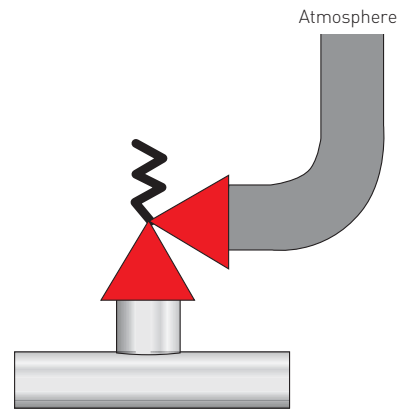
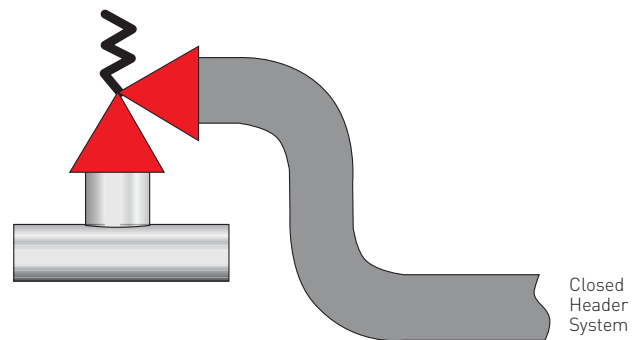


FIGURE 4-20  
 Closed Header System Discharge Piping



**Discharge Piping Considerations**

As with inlet piping, pressure losses occur in piping configurations that are attached to the outlet connection of a pressure relief valve that has opened and is discharging the service fluid. This occurs whether the PRV is discharging to atmosphere via a tailpipe as shown in Figure 4-19 or into a closed header system in Figure 4-20.

Either type of discharge piping causes built-up back pressure and this back pressure can affect the performance of the conventional direct acting valves discussed up to this point. The balance of forces for a conventional direct spring PRV is critical. Any change in pressure within the valve body downstream of the seat, disc holder and huddling chamber can disturb the lift forces. When the conventional valve is open, the built-up back pressure will assist in reseating the valve as additional downward force is applied on the top of the disc holder and from the spring bonnet as shown in Figure 4-21.

Most manufacturers of conventional pressure relief valves and many recommended practices such as API 520 Part I suggest that the back pressure, calculated at the discharge flange, not exceed the overpressure allowed for proper lift and capacity. For example, if the conventional PRV is operating with 10% overpressure, then the gauge built-up back pressure at the outlet flange should not exceed the gauge set pressure by more than 10%. If the built-up back pressure exceeds this allowable overpressure, the conventional valve could operate in an unstable fashion.

Open spring bonnet conventional valves (see Figure 4-15) help to dissipate the back pressure that builds up above the moving trim components. Therefore, an open bonnet Section I safety valve which may only have 3% overpressure to operate, will be able to maintain its stability when built-up back pressures exceed 3%. Some manufacturers will allow 20% built-up back pressure or higher for some open bonnet Section I designs.

API Standard 521 or ISO 23251 will tell the user to calculate the built-up back pressure for most direct acting valves by using the rated capacity for the device (see Table 3-3 for more details). If the calculated built-up back pressure is higher than the overpressure used to size the conventional direct acting PRV, then the discharge piping should be shortened, straightened or enlarged.

When the PRV outlet is connected to a closed disposal system, it is a good possibility that there will be pressure in this outlet piping before the PRV may be called upon to relieve. This type of back pressure is called superimposed. A PRV datasheet will normally have two fields for superimposed back pressure, one that would list "constant" and one that would list "variable."

An example of constant superimposed back pressure might be a relief valve protecting the discharge of a pump. It is common to send the discharge piping of a pump relief valve back into the suction side of the equipment. This suction pressure may be the same at all times.

In Figure 4-22, the green color depicts a constant superimposed back pressure for a closed conventional direct acting PRV. There is a portion of the upper disc area located within the nozzle inside diameter where the superimposed back pressure will add downward force to the disc. This adds to the sealing force provided by the spring. The effect to most conventional direct acting spring loaded valves is that for every one unit of superimposed back pressure that the valve is exposed to, it will add one unit to the in situ opening pressure.

FIGURE 4-21  
 Effect of Built-up Back Pressure on Conventional PRV

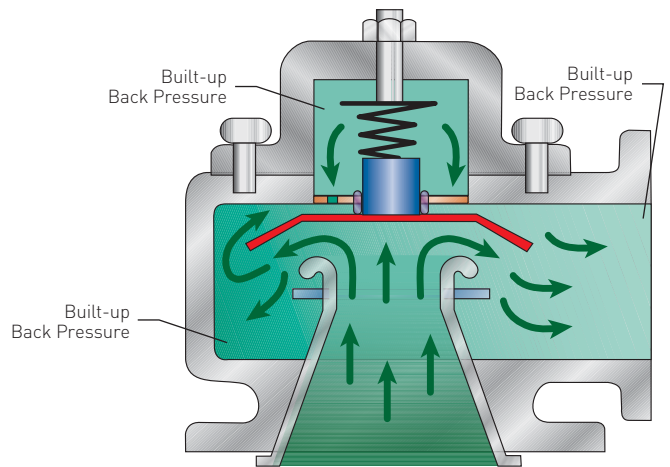
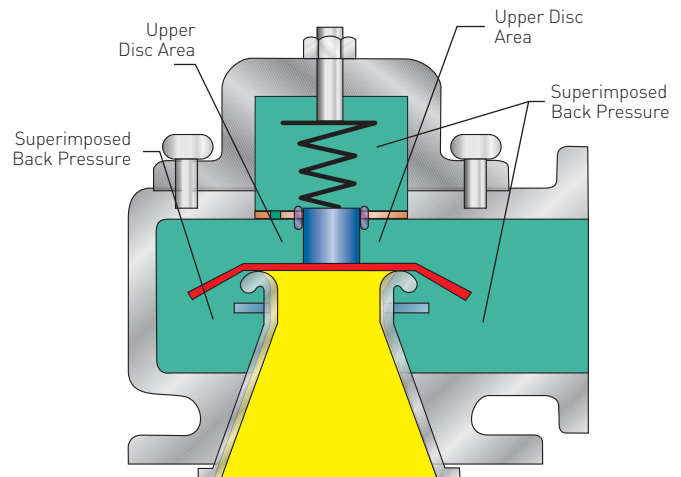


FIGURE 4-22  
 Superimposed Back Pressure in a Conventional Direct Spring Loaded PRV



Therefore, if the suction pressure of the pump (i.e. superimposed back pressure) is constant, then the test bench pressure for the conventional PRV can be biased to open the valve at the proper pressure.

Using the pump relief valve as an example, let us say the pump outlet design will require the relief valve to open at 100 psig (6.90 barg). The suction pressure is 25 psig (1.72 barg). The test bench setting of the valve would be 75 psig (5.17 barg). This adjustment, due to superimposed back pressure, is one element of the cold differential test pressure (CDTP) used to set pressure relief valves on the test bench.

In many instances, the superimposed back pressure is not a constant value. This is especially true when a PRV is ultimately discharging into a flare header (see Figure 3-14). There may be other PRVs, system blowdown valves, purge lines and so on that may also be connected to these header systems. The superimposed back pressure will vary depending upon what device is supplying pressure to the header. Since the superimposed back pressure increases the opening pressure of a conventional pressure relief valve, safety may be compromised. Therefore, it may be prudent to consider a different design type for a direct acting PRV.

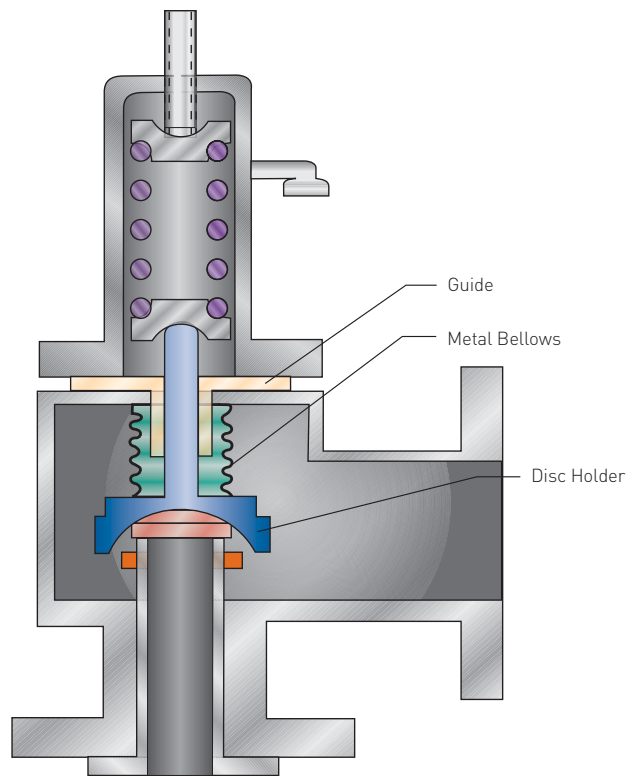
#### Direct Spring Safety Relief Valve Operation - Balanced Designs

A balanced direct acting spring loaded valve is designed to open at its test bench pressure setting no matter what the magnitude of superimposed back pressure. A balanced valve has essentially the same trim components as a conventional valve. In order to provide immunity to the opening pressure change caused by the variable superimposed back pressure, there are some additional parts added to a balanced valve. One way to make the top of the disc (holder) area that is exposed to the back pressure equal to its bottom area that is exposed to the back pressure is to add a bellows to the trim as shown in Figure 4-23. The bottom portion of the bellows is normally screwed onto the disc holder and sealed with a gasket. The top of the bellows has a flange surface that is sandwiched between the guide and the valve body to hold the bellows. The bellows isolates the area on the top of the disc holder that is equal to the nozzle inside diameter. The superimposed back pressure is now exposed to the same area on the top and bottom of the disc holder and thus there is no change in the opening pressure. The valve now is balanced.

The bellows will also allow the direct acting PRV to be exposed to higher built-up back pressure values because of the area balance. The spring bonnet is isolated which helps to minimize the effect that back pressure provides to reclose the PRV. Most API 526 balanced bellows valves for gas/vapor applications will allow for a total back pressure (built-up plus any constant and variable superimposed back pressure) to be up to 30% of the gauge set pressure in applications where 10% overpressure is used to provide full lift of the disc, with no reduction in capacity. If the allowable overpressure is higher than 10%, then the total back pressure can be higher than 30% of the gauge set pressure with no capacity reduction.

An additional feature of a balanced bellows PRV design is that the guide and disc holder interface, as well as the spring, are always isolated from the process being relieved and from the media in the discharge piping. As earlier mentioned, the tolerance between the dynamic disc holder and static guide is important for the performance of the valve. The bellows will keep this area isolated from any debris that may interfere with proper movement of the disc holder. Another benefit of isolating the spring via the bellows may be an economic one when the media may necessitate a higher alloy spring material due to compatibility.

Figure 4-23  
Balanced Bellows Direct Spring PRV



Please note the spring bonnet vent in Figure 4-23. All balanced valves will have a vented bonnet to provide a release port for any downstream media that might leak past the bellows or its gaskets. Recall that the superimposed back pressure increases the opening pressure so it is important to not trap this back pressure in the spring bonnet. The vent also provides an indication of damage to the bellows. If the fluid is hazardous, then this vent may be ported to a safe location but it still should be referenced to atmospheric pressure.

It should be noted that the bellows has a limit to the total magnitude of back pressure that may be in the downstream piping. Keep in mind that the bellows has to be flexible enough to still allow the proper lift of the disc at 10% overpressure and this tends to limit the burst rating of the bellows. For example, API 526 shows a typical balanced bellows valve to have a maximum total back pressure of 230 psig (15.9 barg) for many of the smaller size valves and can be as low as 30 psig (2.07 barg) for certain 8" x 10" (200 mm x 250 mm) configurations.

Some manufacturers offer an alternative to the bellows design to provide a balanced valve. Figure 4-24 shows what is called a balanced piston trim for a direct acting spring loaded PRV. This is also known as a balanced spindle trim where the disc holder and guide have seals that isolate the spring bonnet from any back pressure. The disc holder is now a sealed piston or spindle component that, if properly designed, will not let any service fluid escape into the spring bonnet during operation. The diameter of the spindle seal is equal to the inside diameter of the nozzle so that any superimposed back pressure will act on equal areas on the top and bottom of the disc holder and thus have no effect on the opening pressure.

An advantage of the balanced piston or spindle valve is that it can typically accommodate higher back pressures because there is no bellows to burst. As with a balanced bellows valve, the balanced spindle valve has a vent in the spring bonnet to provide an indication that back pressure has entered the spring area of the PRV. A disadvantage is that the guide seal and spindle seals are normally elastomers or plastic so temperature and chemical compatibility with the service fluid needs to be considered.

There are some direct acting spring loaded valves that use a combination of a bellows and balanced piston. The bellows provides the primary device to balance the trim and a balanced piston is located inside the bellows to provide a back-up if the bellows becomes compromised.

FIGURE 4-24  
 Balanced Piston Direct Spring PRV

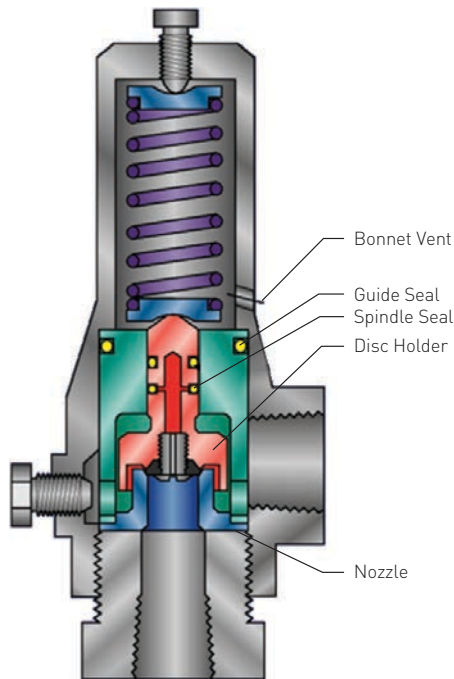
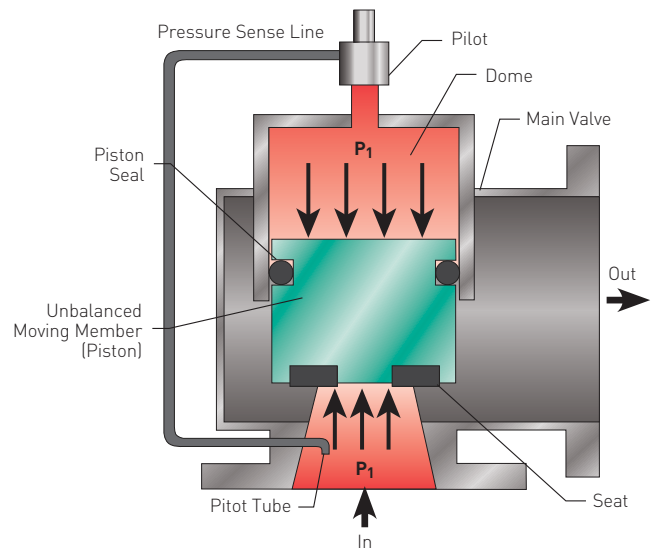


FIGURE 4-25  
 Piston Type Pilot Operated PRV



**III. PILOT OPERATED PRESSURE RELIEF VALVES**

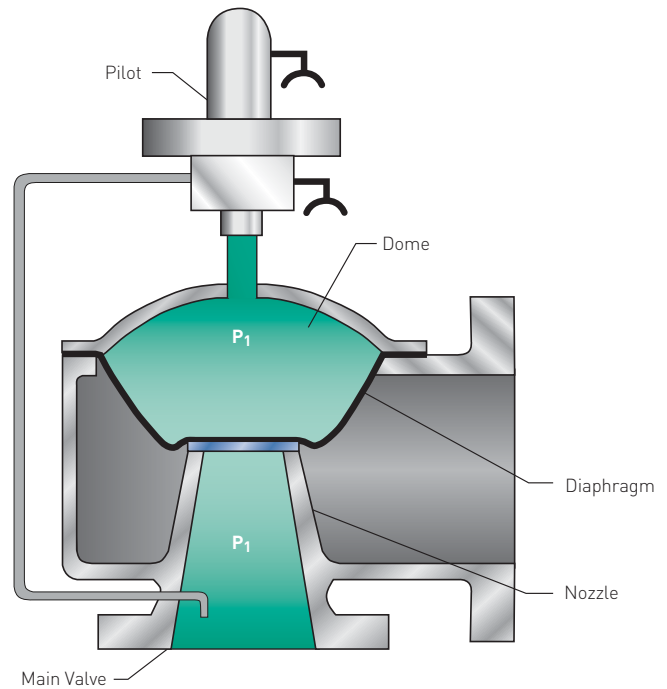
Pilot operated pressure relief valves use process pressure, instead of a spring or weight, to keep its primary seat disc closed at pressures below set. Figure 4-25 shows two major components of the pilot operated PRV, the main valve and pilot valve.

The main valve is attached to the vessel or system being protected and determines the available relieving capacity. The pilot valve controls the opening and closing of the main valve. The process pressure ( $P_1$ ) enters the main valve and exerts an upward force on the seat which is similar to a direct acting valve. This same process pressure in Figure 4-25 is also transmitted up the pilot valve via the pilot tube and pressure sense line into the pilot. The pilot is essentially a direct acting spring loaded device where a compressed spring holds down a seat. This compressed spring determines the set pressure of the entire pilot operated pressure relief valve. The process pressure entering the pilot acts upon a pilot seat. When the  $P_1$  value is less than the set pressure, the process fluid is allowed to exit the pilot and re-enter the main valve on top of an unbalanced trim member. Figure 4-25 shows a piston to be the unbalanced component. When pilot valves are used at set pressures less than 15 psig (1.03 barg), or in vacuum protection applications, it is common to use a lighter weight unbalanced member, such as a diaphragm (Figure 4-26). The volume above the piston or diaphragm is often called the dome. The piston is called "unbalanced" because the piston seal (Figure 4-25) has a larger exposed area to the process pressure ( $P_1$ ) than the seat area. Since force is equal to the pressure times the area being acted upon, the higher the process or operating pressure, the tighter and tighter the main valve seat becomes. This feature is completely the opposite of a direct spring valve where the minimal seating force is just before the valve must open. The benefit of the pilot operated PRV is that it may be possible to operate a system closer to the valve's set pressure and not have leakage or unwanted opening cycles. Most pilot operated PRV designs will allow for an operating pressure to be 95% of the set pressure with no process leakage. Some pilot designs even allow an operating pressure up to 98% of the set pressure. This increased operating pressure can optimize the equipment design and allow for the maximum throughput for the process.

The opening and closing operation of the pilot operated PRV will be discussed later in this section.

The size of the pilot valve itself remains constant no matter what size main valve is required to deliver the capacity. This feature can provide several advantages over the direct acting PRV. Since the pilot seat remains small relative to the seat of a direct acting spring PRV, one advantage is that the pilot operated PRV can be used in higher set pressure applications in comparable line sizes. Once again, back to the force equals pressure times area relationship, the larger the seat in a direct acting spring PRV, the higher rate the spring design must be to properly seal the valve. The spring and its bonnet required become very large, the total mass of the valve very heavy and the total cost more expensive. The same exact pilot that is set, for example, at 1000 psig (69.0 barg) can be used on a 1D2 through 8T10 main valve. API Standard 526 for instance will show an upper set pressure of 300 psig (20.7 barg) for the spring loaded 8T10 valve. If the set pressure is over 300 psig (20.7 barg) and the required capacity dictates a "T" orifice valve, the user may have to install multiple, smaller orifice, spring loaded PRVs, where one pilot operated PRV would be able to provide the needed capacity.

FIGURE 4-26  
Diaphragm Type Pilot Operated PRV



One other way to optimize the available relieving capacity is to install this common pilot onto what is called a "full bore" orifice main valve. Table 4-1 shows the typical API 526 orifice sizes compared to the full bore orifice. The use of the full bore main valve can save money on not only the valve itself but on the total installation cost.

The height and weight savings from using a common pilot through the main valve size range may also hold some benefit when clearances are tight in a pipe rack or to minimize weight. Table 4-2 gives a comparison of weights and Figure 4-27 illustrates the size difference in two 6R8 valves.

**TABLE 4-1 - FULL BORE VS API ORIFICES**

Valve Size in (mm)	API in <sup>2</sup> (mm <sup>2</sup> )	Full Bore in <sup>2</sup> (mm <sup>2</sup> )	
1.5 x 2 (40 x 50)	0.785 (506.5)	1.496 (965.2)	+90%
2 x 3 (50 x 80)	1.287 (830.3)	2.895 (1868)	+125%
3 x 4 (80 x 100)	2.853 (1841)	6.733 (4344)	+135%
4 x 6 (100 x 150)	6.380 (4116)	10.75 (6941)	+68%
6 x 8 (150 x 200)	16.00 (10,320)	23.32 (15,050)	+45%
8 x 10 (200 x 250)	26.00 (16,770)	44.17 (28,500)	+70%

**TABLE 4-2 - WEIGHT COMPARISONS**

Valve in (mm)	Inlet Flange	Typical Direct Spring PRV lbs. (kg)	Typical POPRV lbs. (kg)	Weight Savings
8" x 10" (200 x 250)	150#	600 (272)	421 (191)	30%
4" x 6" (100 x 150)	300#	230 (104)	160 (73)	30%
3" x 4" (80 x 100)	600#	160 (73)	92 (42)	42%
2" x 3" (50 x 80)	600#	70 (32)	53 (24)	24%
1.5" x 2" (40 x 50)	900#	50 (23)	45 (20)	10%

Provided that conditions are suitable, we learned in Chapter 3 that the pilot operated PRV can be used for any ASME Section I or VIII installation. In order for a pilot operated PRV design to be certified per the ASME Code, the design must be shown to be fail-safe if any essential part of the valve is compromised. For example, if the piston seal is damaged and cannot hold pressure in the dome volume, the main valve will fail open. One other provision of the Code is that the pilot valve must be self actuated and use the process itself and not an external source to operate. The pilot will use the process pressure to either snap open or modulate the main valve during a relief cycle.

**Snap Action Pilot Design**

The first pilot design that was developed was a "pop" or snap action type that allowed the main valve to obtain significant lift at the set pressure. Figure 4-28 shows the snap action pilot operated PRV in the normal closed position. The red color represents the process pressure and when the pilot relief seat is closed, this pressure is ported to the dome area of the main valve. The pressure is the same at the main valve inlet and dome and the larger piston seal provides the downward seating load. The pilot relief seat is held closed by the compression of the pilot spring. The pilot relief seat is the outlet for the trapped pressure being held in the dome of the main valve. When the process pressure beneath the relief seat overcomes the spring compression, the pilot will open allowing the dome pressure to exhaust to atmosphere as shown in Figure 4-29. A snap action pilot will reduce the dome pressure to nearly atmospheric immediately upon opening and this will allow full travel or lift of the main valve piston or diaphragm at set pressure. Recall that API Standard 526 direct acting spring loaded safety valves are also pop action type valves but they only go into a partial lift at set pressure, usually no higher than 70% of full lift. Overpressure is required to obtain the full lift for a direct acting spring PRV but no overpressure is needed for full main valve lift when using a snap action pilot operated PRV. You will notice in Figure 4-29 that the pressure at the inlet of the pilot remains at the set pressure when the main valve is opening and relieving. This is indicative of what is termed a "non-flowing" pilot operation. A non-flowing pilot design prohibits the process fluid from circulating through the pilot during the relieving cycle. This is accomplished in Figure 4-29 by using a second pilot seat called the blowdown seat which will seal off when the pilot relief seat opens.

**FIGURE 4-27**  
 Height Comparison of Direct Spring vs Pilot Operated PRV  
 (6" x 8" valves shown)



This block and bleed type of operation keeps the pressure static in the sense line from the process being protected to the pilot valve. The pilot relief seat and blowdown seat cannot be open at the same time, thus eliminating flow through the pilot when the main valve is open. The first pilot valves that were designed were "flowing" pilot designs that did not have this blowdown seat feature. These pilots were limited to services where there was minimal debris or moisture in the system so that the pilot could reliably reload the dome pressure in the main valve to close the assembly. If there was a blockage in the sense line or pilot, the main valve would remain open. The non-flowing pilot designs were first introduced over 40 years ago and have proven that, if properly designed and applied, they can be used where dirt, hydrates and high moisture content occur in the fluid media.

FIGURE 4-28  
Pop Action Pilot Operated PRV (closed)

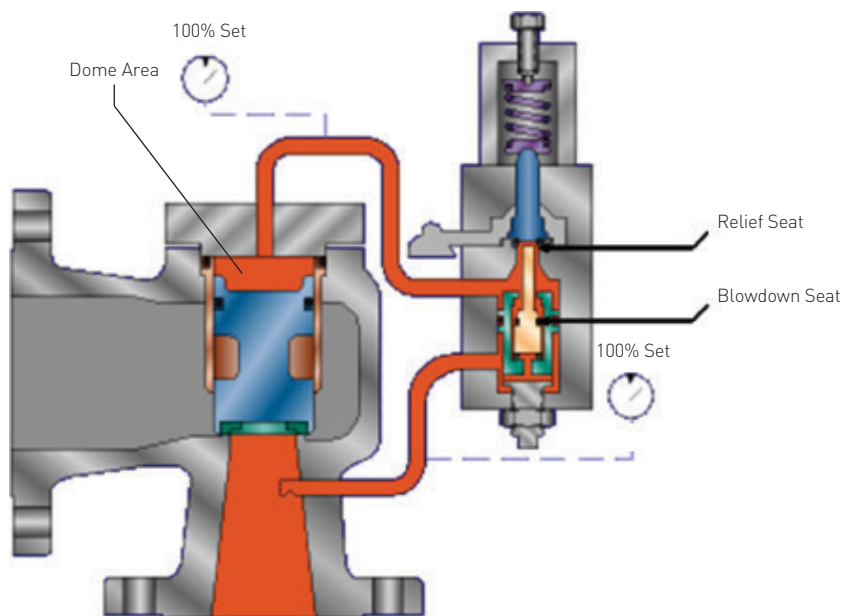
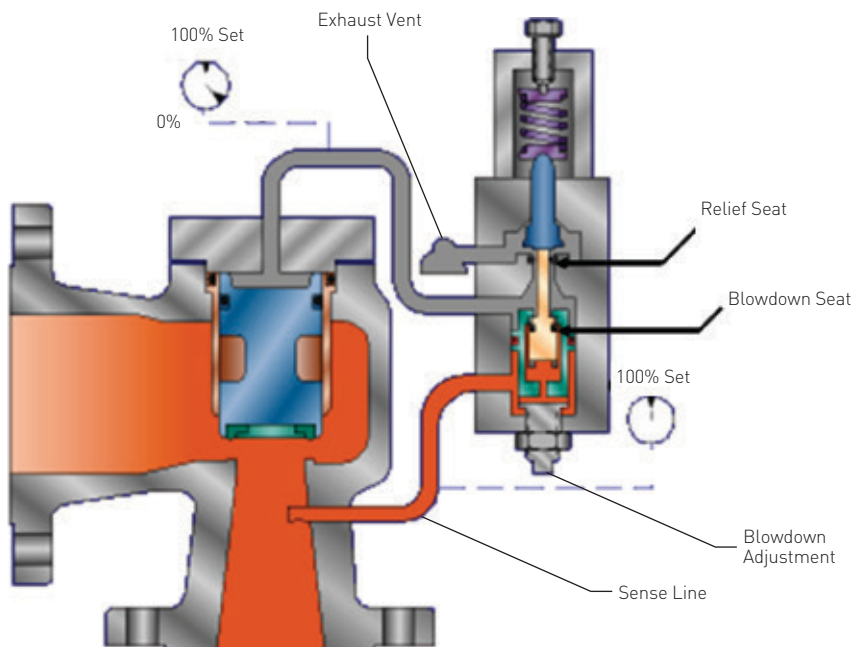


FIGURE 4-29  
Pop Action Pilot Operated PRV (open)



The main valve recloses when the pilot valve senses a reduced process pressure and the relief seat closes and blowdown seat opens simultaneously thus reloading the dome pressure. The dome volumes are minimal, for instance a 2" x 3" (50 mm x 80 mm) main valve typically has just over 3 cubic inches (50 cubic cm) above the piston. The blowdown is adjustable for most snap action, non-flowing, pilot valve designs. Unlike a direct acting spring loaded valve, there are no blowdown rings used for the adjustment. It is the physical upward travel of the pilot relief and blowdown seats that determines the reseal pressure of the pilot and subsequently the main valve. The blowdown seat is contained in a component that has a spacer between the blowdown seat and relief seat. This spacer provides a direct communication between the two seats when pilot relief seat is open as shown in Figure 4-29. The more compression imparted to the spring during its opening cycle, the higher the reseal pressure or the shorter the blowdown. The blowdown adjustment screw shown in Figure 4-29 can be rotated into or out of the bottom of the pilot body. This threaded component changes the position of the blowdown seat stop. The higher the stop, the more spring compression and the shorter the blowdown. The typical performance curve for a snap action pilot operated PRV is shown in Figure 4-30. Since these pilots open the main valve to full lift, a snap action pilot is considered a safety valve and suitable only for compressible media. The pilot relief seat needs the gas or vapor expansion properties to remain open during the relief cycle so that the dome pressure can exhaust immediately. This pilot design may be unstable in its lift when used in liquid applications.

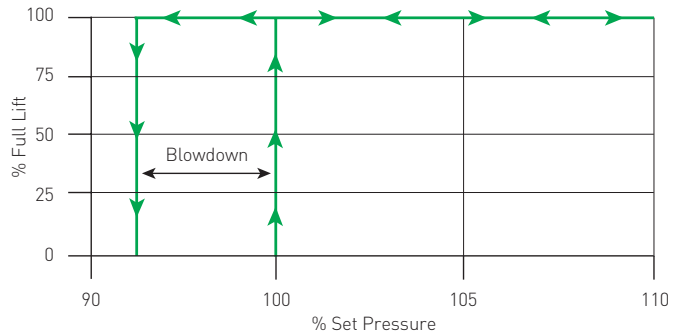
**Modulating Action Pilot Design**

As with direct acting spring loaded PRVs, there are design alterations that need to be made to enable a pilot operated PRV to operate suitably in incompressible media. In order to provide stability during lift in a liquid application, the pilot design should not allow the immediate full evacuation of dome pressure to occur at the set point. A regulated amount of the dome pressure should be reduced by the pilot during operation so that the main valve unbalanced member, such as the piston, is at some partial lift position to throttle or modulate the release of the service fluid. Most manufacturers will physically change the complete pilot assembly from a snap action design to this modulating action design and use the same main valve assembly.

There are flowing and non-flowing modulating pilot designs that are provided today. The most common style is the non-flowing designs that keep the velocity in the pilot low to minimize the exposure that the pilot may have to debris in the system.

Figure 4-31 shows a similar main valve assembly that was discussed for snap action pilot designs. The snap action pilot has now been replaced with a modulating action pilot. The green color illustrates the process pressure entering the main valve and exerting an upward force on the main valve seat. This same pressure is allowed to enter the modulating action pilot via the pitot tube and is ported to a sense diaphragm in this particular pilot design. The simmer and set pressure of the complete pilot operated PRV assembly are determined by the spring compression and the exposed area of the sense diaphragm to the process pressure. The sense diaphragm is mechanically attached to the feedback piston component and these two trim parts will move as one when necessary. When the process pressure is below the simmer point of the pilot, the pilot spring positions the feedback piston via the sense diaphragm to allow the pilot inlet seat shown in Figure 4-31 to be open. The inlet seat communicates the process pressure from the inlet of the pilot to the dome of the main valve. The process pressure is then providing a downward force to the piston via the piston seal, keeping the main seat closed.

FIGURE 4-30  
 Main Valve Lift vs Set Pressure for Pop Action Pilot Operated PRV



The difference in the sealing area of the piston seal and the exposed area of the main seat to the process pressure is a notable parameter. This difference will be important in calibrating the pilot to open the main valve at the proper pressure. As an example, many of the piston main valve designs have approximately a 30% larger piston seal area versus the main valve seat area. Since the modulating pilot is regulating the exhaust of the dome pressure when it operates, the main valve will not open until a minimum 30% of the dome pressure is released. If we have an installation where the required set pressure is 100 psig (6.90 barg), then the pilot must reduce the dome pressure to 70 psig (4.83 barg) with 100 psig (6.90 barg) at the pilot sense diaphragm.



The sequence of events that occurs in the pilot to allow the main valve to modulate open is as follows. Referring to Figure 4-32, as the process pressure nears the set point, the sense diaphragm begins to move upward to compress the spring. Recall that the feedback piston moves with the sense diaphragm, therefore the inlet seat of the pilot will close. If the process pressure continues to rise, the feedback piston will continue to move upward and will literally pick up the spool shown in the pilot trim detail portion of Figure 4-33. Once this occurs, the outlet seat opens and allows the dome pressure to begin to bleed out. This initial release of process from the pilot will not signify the set pressure because there is still enough pressure in the dome to keep the main valve closed.

If the process pressure stabilizes during this initial pilot opening, the feedback piston and spool piece areas are designed to allow the pilot spring to close the outlet seat. When the inlet seat and outlet seat are closed this is called the "null" position. There is no pilot flow in this null position. This is shown in the pilot trim detail of Figure 4-32.

If the process pressure continues to increase, then the outlet seat will remain open and the dome pressure will reduce to a level (oftentimes this is 30% below the main valve inlet pressure) where the main valve opens. This is the set pressure of the complete pilot operated PRV assembly.

As the process pressure rises above this set pressure, dome pressure reduction will continue and this will position the main valve piston lift to a point where the process pressure stabilizes. The feedback piston and spool will position the pilot inlet and outlet seat to close to provide no flow through the pilot when the main valve is open. This is shown in Figure 4-32.

If the process pressure continues to rise, the pilot outlet seat will open until the main valve obtains the needed lift to deliver only the required capacity of the overpressure contingency. Once the process pressure begins to decay, the inlet seat will open and dome pressure will be restored to begin the closing cycle of the main valve. At no time during its operation will the pilot inlet seat AND outlet seat be open at the same time. This prevents a continuous flow in the pilot.

A graphical representation of the modulating pilot open and closing cycle is shown in Figure 4-34. Unlike the snap action pilot design, but like the direct acting spring operated PRV design, there is overpressure required to obtain lift. It should be noted that the modulating action pilot operated PRV, in addition to liquid service, is also suitable for use in gas applications or a mixture of gas and liquids. It is a true safety relief valve and can be ASME certified for either service. In compressible, incompressible, or multi-phase flow, the performance curve is as depicted in Figure 4-34.

FIGURE 4-31  
 Modulating Action Pilot Operated PRV (closed)

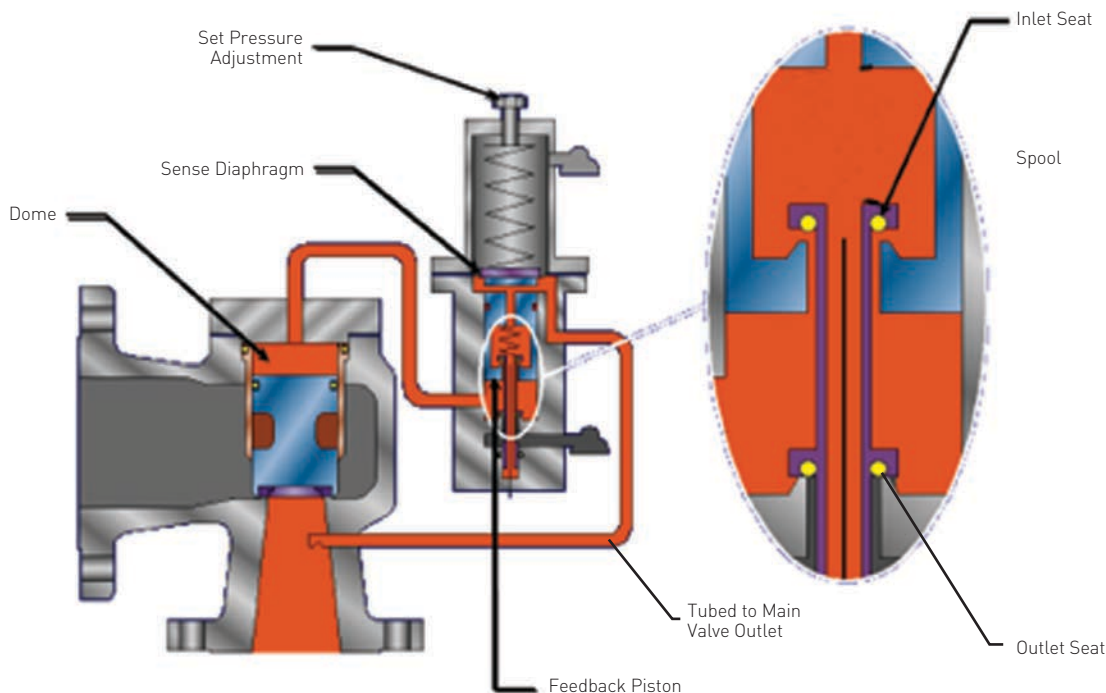


FIGURE 4-32  
Modulating Action Pilot Operated PRV (open)

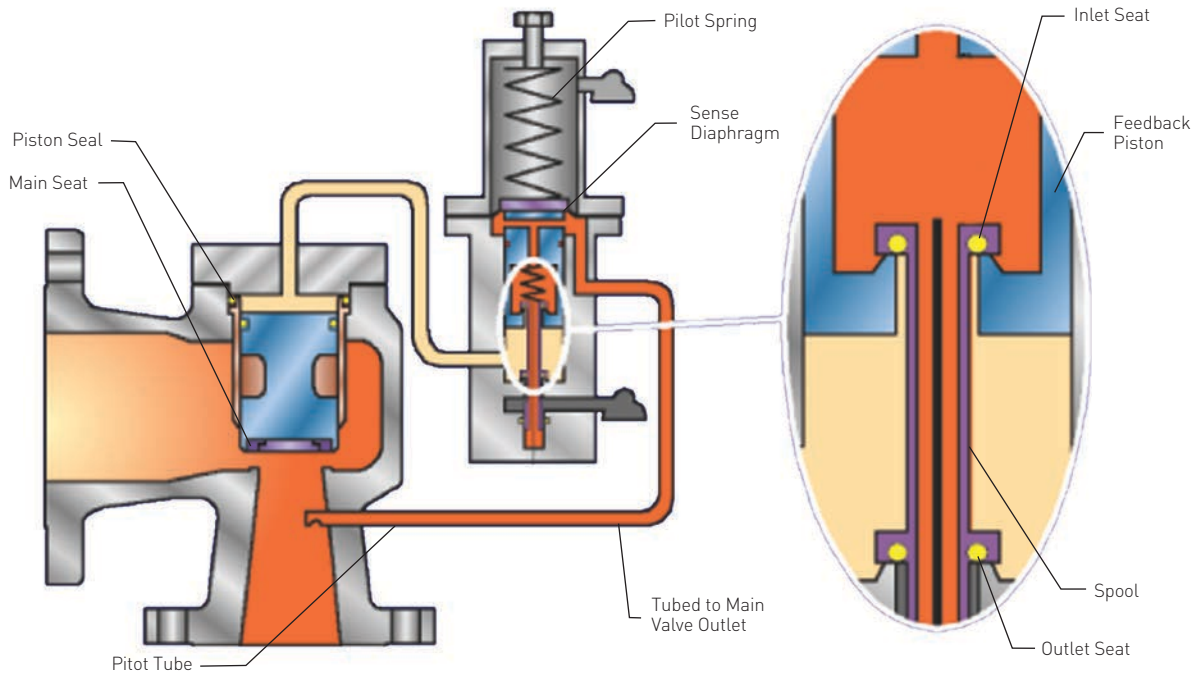
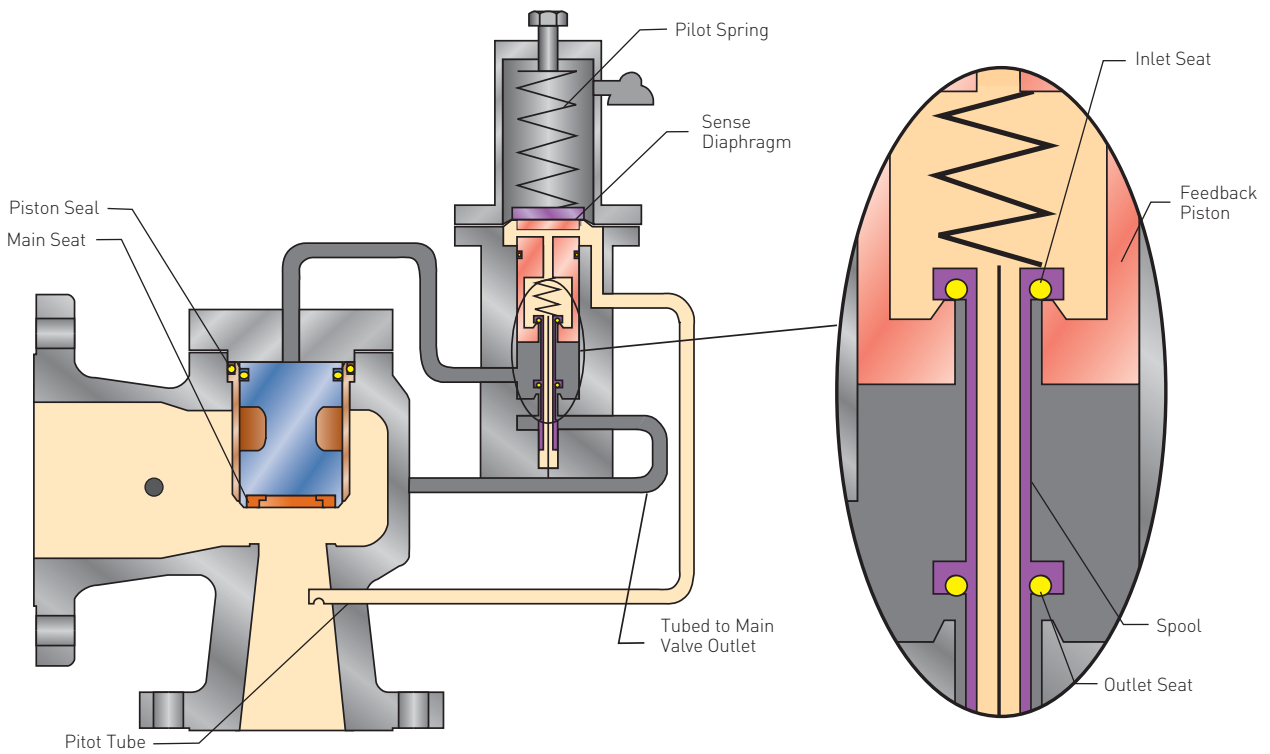


FIGURE 4-33  
Modulating Action Pilot Operated PRV (open and in full lift)



Unlike the direct spring operated PRV, the main valve will only open to a lift needed to flow the required capacity. Recall in Figure 4-7 or 4-12, there is an abrupt lift (but not a full lift) at set pressure for gases or a gush of liquid during the overpressure of a direct acting relief valve. If there is any capacitance in the inlet piping to the valve, these direct acting devices may initially flow more than the source of overpressure can provide. The modulating action pilot operated PRV operation will conserve the product during an upset, minimize interaction with control valves trying to balance the system, lower reaction forces in the piping supporting the PRV, reduce noise levels and provide stability at low required capacity relieving contingencies. API Standard 521 and ISO 23251 will allow piping that is immediately downstream of a modulating PRV to be sized based upon the required capacity rather than the rated capacity. This can optimize the pipe size and save installation costs. The blowdown for the modulating pilot valve assembly is minimal. Most modulating pilot designs will have a worst case blowdown of 3% to 4% for either gas, liquid or multi-phase applications. In multi-phase applications this can provide an advantage over the direct acting spring loaded valve especially when the quality of the gas portion of the fluid is high which can create a blowdown as much as 20%.

**Pilot Operated Pressure Relief Valve Seat Designs**

The majority of pilot operated pressure relief valves provided today utilize soft seats and seals in the main valve and the pilot. This helps to provide the tight shutoff of the process as the operating pressure approaches the set pressure. There is no difference in the API Standard 527 leakage standards between direct spring or pilot operated pressure relief valves. As noted previously, a soft seated valve design is normally tested at 90% of the set pressure and the requirement is zero leakage. Many manufacturers will do a leak test of their pilot valve assemblies up to 95% of the set pressure in many instances.

FIGURE 4-34  
 Main Valve Lift vs Set Pressure for Modulating Action Pilot Operated PRV

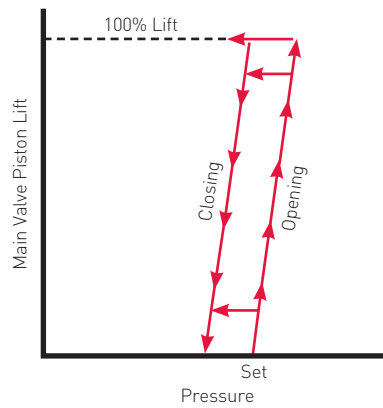
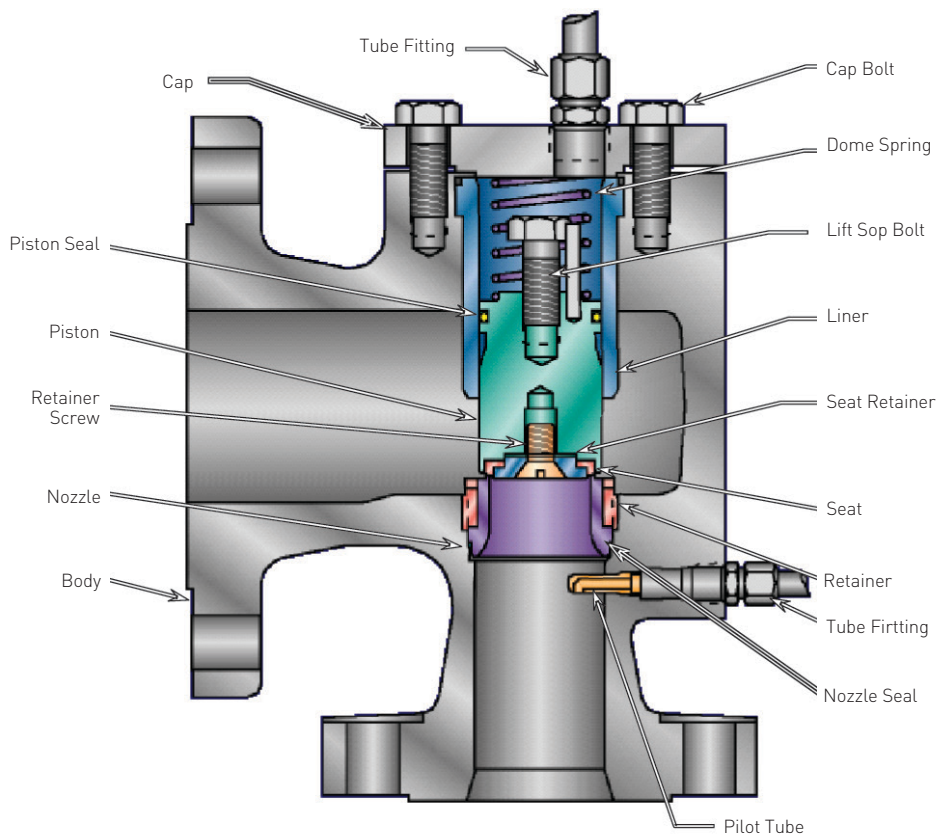


FIGURE 4-35  
 Piston Type Main Valve Components



Recall that the service fluid and temperature play an even more important role in selecting a soft seat material versus metal seat material. Since pilot operated valves are often selected for high pressure applications, the design of the main valve seat containment and the material is of importance for the reliability of the seat during operation. There are main valves with metal seats available for use with soft seated pilots that may provide durability in the high velocity flow area of the assembly. However, when the pressure, temperature or chemical property of the process fluid is not suitable for an elastomer or plastic material, there are also full metal seated and sealed main valves and pilots available.

**Pilot Operated Main Valve Components**

A typical piston style main valve is shown in Figure 4-35. The pitot tube orientation is important for proper valve operation. This component should be oriented to face directly at the flow of fluid that will occur during start-up to assist in loading pressure into the dome, and for relieving conditions to provide the pilot with an accurate stagnation pressure reading for operation. Most main valve assemblies use semi-nozzle designs as shown in Figure 4-35. This is due to the needed intrusion of the pitot tube into the inlet bore of the main valve. It is difficult to orient a threaded-in full nozzle to align its porting with the pitot tube porting. Full nozzle main valves are available, but many designs require the pressure pick-up to be remote sensed. The remote sensing of pilot valves will be discussed later. These semi-nozzles could be screwed, swaged, welded or internally retained to stay in place in the main valve.

FIGURE 4-36  
 Remote Sense Pilot Operated PRV

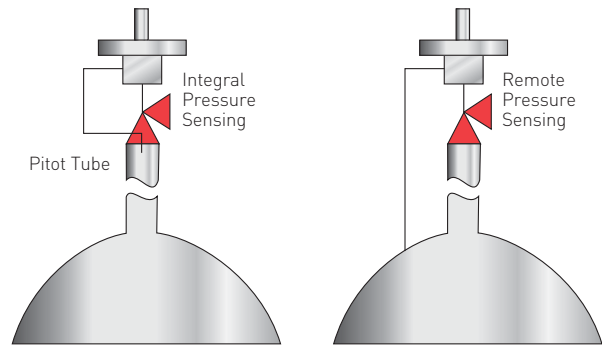
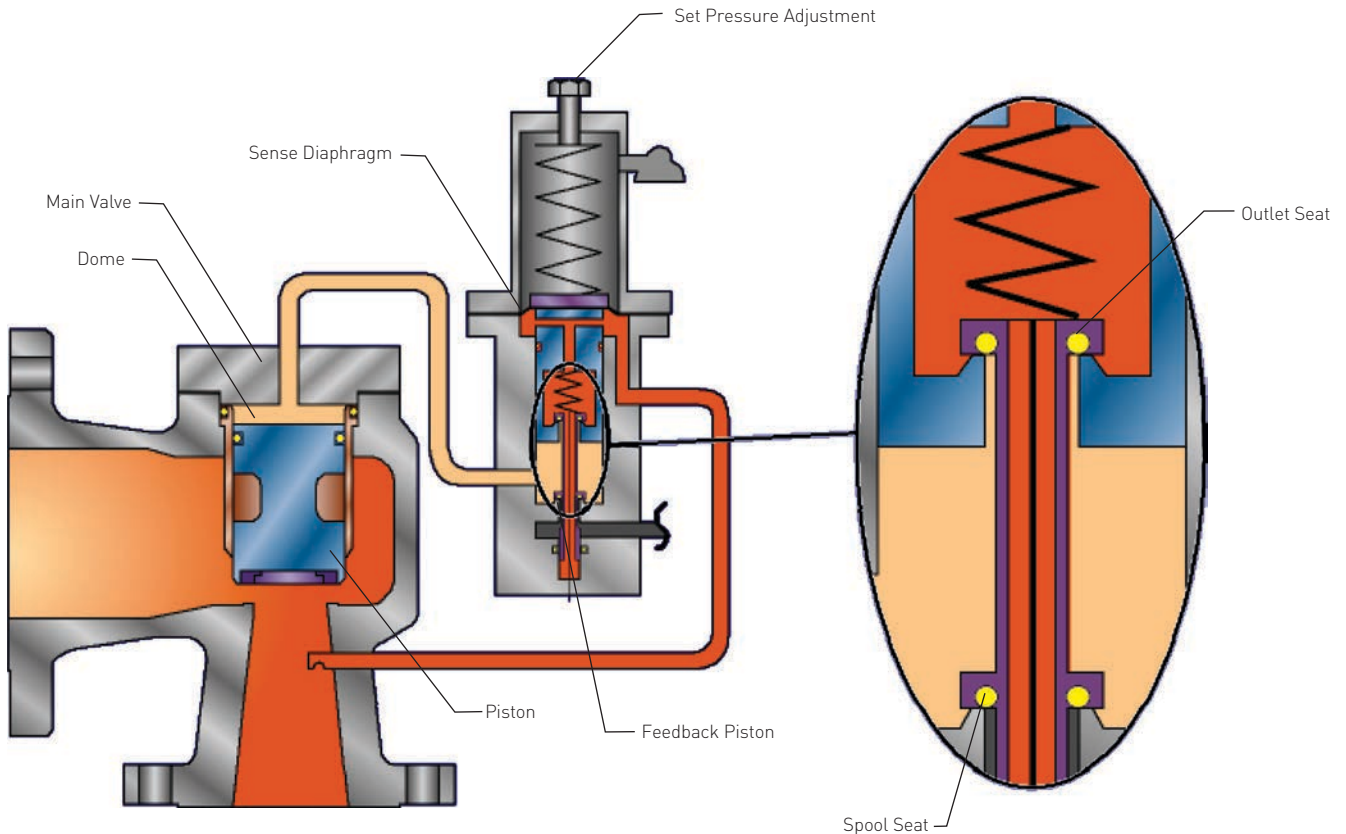


FIGURE 4-37  
 Balanced Modulating Pilot Operated PRV



# PRESSURE RELIEF VALVE ENGINEERING HANDBOOK

## CHAPTER 4 - DESIGN FUNDAMENTALS

The valve shown in Figure 4-35 is soft seated. The seat is held in place with a retainer and retainer screw assembly. As mentioned previously, the containment of this seat is important to hold it in place during a relieving cycle. Some manufacturers will drill a hole in the seat retainer so that pressure can equalize across the soft seat. This hole will provide an exhaust of trapped process pressure during an opening cycle so the seat will not extrude and blow out.

Just as with the disc holder and guide of a direct acting spring loaded valve, the materials of construction of the dynamic piston assembly and the static liner part are important factors to prevent galling. These components should have a differential hardness to provide reliable cycle life during normal operation.

The orifice of the main valve can be changed by the physical replacement of one nozzle to another nozzle with a different bore size. Another method is to use the same nozzle and to change the maximum lift of the piston during a relieving case via the lift stop bolt that is shown in Figure 4-35. If this bolt is screwed further into the top of the piston, there will be more available lift and thus more capacity through the main valve.

The dome spring shown does not have a bearing on the opening and closing operation of the complete valve assembly. Some manufacturers install this spring above the piston to help keep the piston closed during shipping and handling. This helps to seal the main valve seat to the nozzle during initial start-up of the process.

The most common inlet and outlet configuration for the main valve is flanged. The API 526 purchasing standard lists the dimensional information for pilot operated valves in one section and direct spring loaded valves in another. It should be noted that some, but NOT all, combinations of similar pipe size, orifice size and pressure class will be interchangeable between the two different types of pressure relief valves.

Use Table 4-3 below as a reference for the comparison of the data in API 526.

The full bore pilot operated valve orifices do not fall under the scope of API 526.

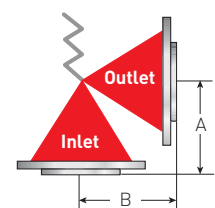
There are also threaded and hubbed connections that are common for pilot operated valves.

**TABLE 4-3 - API 526 DIRECT SPRING VS PILOT OPERATED PRV DIMENSIONS**

	Inlet Flange Rating													
	150#		300# Light Weight		300#		600#		900#		1500#		2500#	
	A	B	A	B	A	B	A	B	A	B	A	B	A	B
1D2														
1.5D2														
1E2														
1.5E2														
1F2														
1.5F2														
1.5E3/														
1.5F3														
1.5G3														
2G3														
1H2														
1.5H2														
1.5H3														
2H3														
2J3														
3J4														
3K4														
3K6														
3L4														
4L6														
4M6														
4N6														
4P6														
6Q8														
6R8														
6R10														
8T10														

**Note:** light weight flange drilled for 300# ASME class bolt pattern but not rated for full 300# ASME class pressure (for DSV only)

- DSV and POPRV Dimensions are the Same
- DSV and POPRV are Different
- Valve Size and Flange Rating not in API 526 for DSV
- Valve Size and Flange Rating not in API 526 for POPRV
- Valve Size and Flange Rating not in API 526 for either DSV or POPRV



**Inlet Piping Considerations**

Pilot operated pressure relief valves with the pilot pressure sensing line connected to the pitot tube at the main valve inlet can experience rapid cycling or chatter due to high non-recoverable inlet losses just as the direct acting spring loaded valve design. This is especially true with snap action pilots.

Figure 4-36 shows the option of remote pressure sensing for the pilot valve. Since the pilot is controlling the opening and closing of the main valve, the remote sense line will allow the pilot to see the true system or vessel pressure without being subjected to inlet pressure losses. This remote sense line will allow the pilot to operate satisfactory, but it should be noted that the capacity that the main valve can deliver will still be affected by the inlet line losses.

There is not a maximum distance limitation for this remote sense line when a non-flowing pilot is selected. The remote sense line remains static when the main valve is opened by a non-flowing pilot. It is recommended to examine any transient conditions that may occur between the main valve location and the remote sense location. Any remote sense line should be self draining back to the process, and piping, instead of tubing, may be warranted for rigidity when these non-flowing pilot sense lines exceed 100 feet (30.5 meters).

If a flowing pilot is to be used in a remote sensing application, the manufacturer should be consulted for guidance on maximum remote sense distances.

**Discharge Piping Considerations**

Pilot operated PRVs can be subjected to built-up, superimposed, or a combination of both types of back pressure. Most pilot valves manufactured today have spring bonnets and trim that are isolated from the built-up back pressure that can be developed during a relief cycle. This allows the pilot to properly control the dome pressure in the main valve to provide stable lift. If you refer back to Figure 4-29, you will recall that the snap action pilot exhausts to atmosphere so there will be minimal built-up back pressure present at the relief seat or spring bonnet.

FIGURE 4-38  
 Sonic to Subsonic Flow Transition

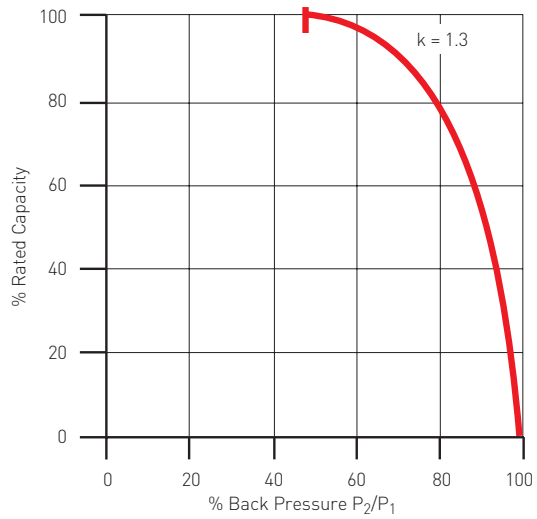


FIGURE 4-39  
 Superimposed Back Pressure in  
 Piston Type Pilot Operated PRV

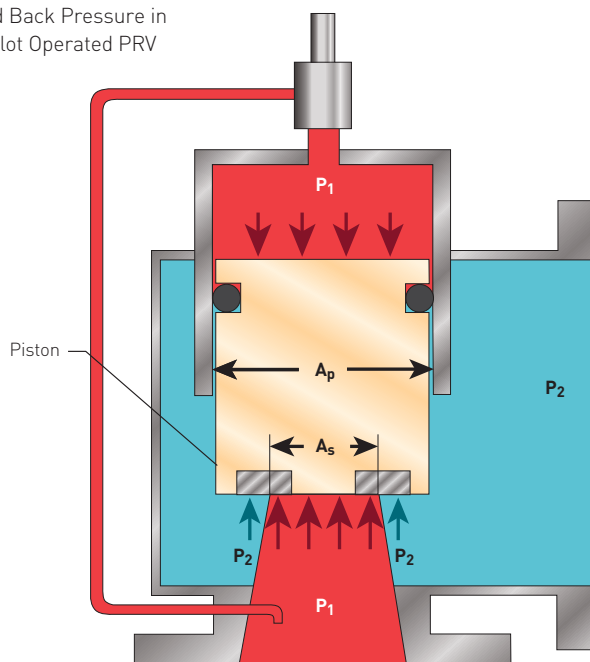
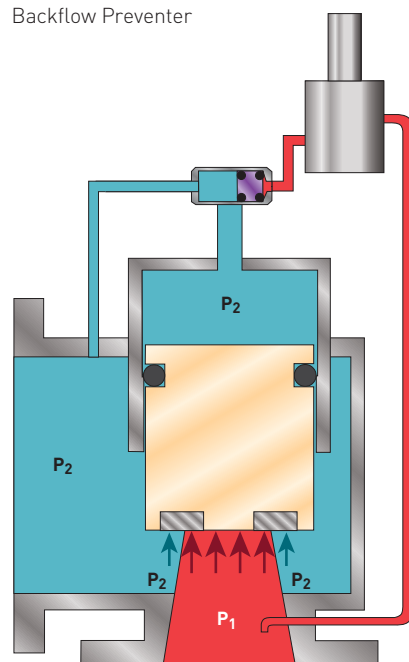


FIGURE 4-40  
 Backflow Preventer



# PRESSURE RELIEF VALVE ENGINEERING HANDBOOK

## CHAPTER 4 - DESIGN FUNDAMENTALS

---

Since modulating pilot valves are often used for liquid applications and since many users do not want any emissions to atmosphere, either liquids or gases, the exhaust port of these valves is typically routed to the main valve outlet. In this case, the trim of the pilot is exposed to the downstream piping and will see the built-up back pressure. In order to not change the force balance in the trim of the modulating pilot, most manufacturers will design the pilot with a balanced spindle. In Figure 4-37, the outlet port of the pilot will see the built-up back pressure. In this area of the pilot, the outlet seat, where the back pressure can act upward and the spool seal, where the back pressure can act downward, are the same effective sealing areas. Therefore, there is no change in the pilot operating characteristics and ultimately main valve lift.

Because of these design features described for a snap action or modulating action pilot, the presence of superimposed back pressure does not affect the opening pressure when the valve is in service. The snap action pilot relief seat will not see the downstream pressure at any time. The modulating action pilot has the balanced spindle design. Since this balanced design is obtained without using a bellows, the pilot operated PRV can be used in applications where the total back pressure exceeds the burst pressure rating of the bellows. It is not unusual for the main valve bodies to have their inlet and outlet flange ratings in a unique combination for a pressure relief valve, such as 900# ANSI x 900# ANSI. As with balanced bellows valves, there are back pressure correction curves that adjust the available capacity from pilot operated PRVs that are exposed to back pressure. Because this type of valve can operate in installations with high back pressure, it is not unusual, in compressible flow, for the back pressure to exceed what is called the critical pressure of the gas. The critical pressure determines whether the gas velocity is sonic or subsonic. Once the gas flow transitions from sonic or choked flow to subsonic, the amount of total back pressure will factor into the capacity calculation. Please note that there is no loss of actual lift in the main valve that causes this capacity reduction, it simply is a result of the gas flowing subsonically. This transition from sonic to subsonic flow occurs when the total back pressure is approximately 50% of the set pressure. The actual value of the critical pressure is determined by the specific heat ratio of the gas. Figure 4-38 shows the sonic to subsonic flow transition for a gas with a specific heat ratio of 1.3.

Outlet piping pressure drop calculations provide the total back pressure up to the outlet flange of the PRV. Since the evaluation of the critical pressure should be at the exit of the area (i.e., the main valve nozzle) that determines the flow capacity, the capacity correction curve for a particular pilot valve may differ than that shown in Figure 4-38. The downstream body geometry of the main valve can add additional built-up back pressure and decrease the available capacity. This is discussed more in Chapters 7 and 8.

As we learned earlier, one feature of the pilot operated PRV is that as the operating pressure increases, the seating force increases. This is an advantage when the operating pressure approaches the set pressure but can be a disadvantage when the superimposed back pressure could exceed the operating pressure. To illustrate, see Figure 4-39. This figure shows how the back pressure ( $P_2$ ) causes an upward force on the main valve piston. If the operating pressure ( $P_1$ ) is not high enough to overcome this upward force, the piston could open and flow backwards from the outlet piping into the system being protected. This backflow could be considered a hazard. This backflow could even occur if the outlet of the main valve is open to atmosphere and there is a normal vacuum condition on the inlet.

To prevent the possibility of reverse flow in the main valve, an accessory called a backflow preventer is required whenever the back pressure could exceed the operating pressure. Figure 4-40 shows a simple shuttle check valve that is mounted on the main valve. The figure illustrates that when the back pressure exceeds the inlet pressure that the shuttle check will allow back pressure to enter the dome of the main valve and provide a net downward loading force to keep the main valve seat tight. The use of the backflow preventer is also recommended whenever the main valve outlet is attached to a piping lateral even though the back pressure may never exceed the operating pressure. There may be cases when the system that the pilot operated PRV is protecting is out of service and there is no operating pressure. If there is back pressure, there is a possibility of the main valve opening in this scenario. The main valve, even with a backflow preventer, should not be considered an isolation device, and blinds or closed isolation valves should be used when the system being protected is idle.

**IV. ADVANTAGES AND LIMITATIONS OF VALVE TYPES**

The following summarizes the advantages and limitations of the pressure relief types discussed in this chapter. The summary is not intended to be an absolute list but a generalization of the pros and cons of each design type. The specific application and prior user experience will play an important role to determine the best recommendation.

<b>Weighted Pallet Type</b>	
<b>Advantages</b>	<b>Limitations</b>
Low initial cost	Set pressure not readily adjustable
Very low set pressures available	Long simmer and poor tightness
Simple	High overpressures required for full lift
	Cryogenic fluids can freeze seat close
	Set pressure limited to 1 or 2 psi (69 mbar or 138 mbar)
<b>Conventional Metal Seated Type</b>	
<b>Advantages</b>	<b>Limitations</b>
Low initial cost	Seat leakage
Wide chemical compatibility	Simmer and blowdown adjustment interactive
High temperature compatibility	Vulnerable to inlet pressure losses
Standardized flanged center to face dimensions	Opening pressure changes with superimposed back pressure
Accepted for ASME Section I and VIII	In situ testing can be inaccurate
	Built-up back pressure limitations
<b>Balanced Bellows Metal Seated Type</b>	
<b>Advantages</b>	<b>Limitations</b>
Wide chemical compatibility	Seat leakage
High temperature compatibility	Simmer and blowdown adjustment interactive
Standardized flanged center to face dimensions	Vulnerable to inlet pressure losses
Protected guiding surfaces and spring	In situ testing can be inaccurate
No change in opening pressure at any superimposed back pressure	Bellows can limit amount of superimposed back pressure
Withstand higher built-up back pressures	High initial cost
	High maintenance costs
<b>Conventional Soft Seated Type</b>	
<b>Advantages</b>	<b>Limitations</b>
Low initial cost	Simmer and blowdown adjustment interactive
Standardized flanged center to face dimensions	Vulnerable to inlet pressure losses
Good seat tightness before relieving and after reseating	Opening pressure changes with superimposed back pressure
Low maintenance costs	Built-up back pressure limitations
	High process fluid temperatures
	Chemical compatibility



# PRESSURE RELIEF VALVE ENGINEERING HANDBOOK

## CHAPTER 4 - DESIGN FUNDAMENTALS

### Balanced Bellows Soft Seated Type

#### Advantages

Standardized flanged center to face dimensions  
Protected guiding surfaces and spring  
No change in opening pressure at any superimposed back pressure  
Withstand higher built-up back pressures  
Good seat tightness before relieving and after reseating

#### Limitations

Simmer and blowdown adjustment interactive  
Vulnerable to inlet pressure losses  
Bellows can limit amount of superimposed back pressure  
High initial cost  
High maintenance costs  
High process fluid temperatures  
Chemical compatibility

### Balanced Piston Soft Seated Type

#### Advantages

No change in opening pressure at any superimposed back pressure  
Withstand higher built-up back pressures  
Good seat tightness before relieving and after reseating  
Low initial cost  
Low maintenance cost

#### Limitations

Simmer and blowdown adjustment interactive  
Vulnerable to inlet pressure losses  
High process fluid temperatures  
Chemical compatibility

### Pilot Operated Soft Seated Type

#### Advantages

Standardized flanged center to face dimensions  
No change in opening pressure at any superimposed back pressure  
Withstand higher built-up back pressures  
Good seat tightness before relieving and after reseating  
Higher set pressures available  
Maximum capacity per inlet valve connection  
Smaller and lighter valves in higher pressure classes and sizes  
In-line maintenance of main valve  
Pop or modulating action  
Remote pressure sensing  
Accurate in situ testing  
Full lift at zero overpressure available

#### Limitations

High initial cost  
High process fluid temperatures  
Chemical compatibility  
Polymer or viscous fluids  
Complexity

**THE FOLLOWING DATA IS INCLUDED IN THIS CHAPTER:**

<b>I. Introduction</b> .....	5.3
Procedure.....	5.3
Pressure Relief Valve Nozzle Coefficient of Discharge.....	5.3
API vs ASME Nozzle Coefficient of Discharge .....	5.3
<b>II. Gas/Vapor Sizing – Sonic Flow</b> .....	5.4
Equations, Variables, Unit of Measures	
<b>III. Gas/Vapor Sizing – Subsonic Flow</b> .....	5.5
Equations, Variables, Unit of Measures	
<b>IV. Steam Sizing</b> .....	5.5
Equations, Variables, Unit of Measures	
ASME Section VIII.....	5.5
ASME Section I` .....	5.6
<b>V. Liquid Sizing</b> .....	5.11
Equations, Variables, Unit of Measures	
Thermal Relief	
<b>VI. Fire Sizing</b> .....	5.11
<b>Liquid Filled Vessels</b> .....	5.11
API 521 (ISO 23251) .....	5.12
API 2000 (ISO 28300) .....	5.14
NFPA 30.....	5.15
NFPA 58/59A .....	5.16
<b>Gas Filled Vessels</b> .....	5.17
API 521 (ISO 23251).....	5.17
<b>VII. Two-Phase Flow Sizing</b> .....	5.17
<b>API 520 Part I (8th Edition)</b> .....	5.18
Two-Phase Flow Mixture Procedure .....	5.18
Subcooled or Saturated All Liquid Flashes.....	5.20
<b>ASME Section VIII</b> .....	5.24
Flashing of Saturated Water .....	5.24
<b>VIII.Noise Level Calculations</b> .....	5.25
<b>IX. Reaction Forces</b> .....	5.26
Gas Service.....	5.26
Steam Service .....	5.26
Liquid Service.....	5.27
Two-Phase Service .....	5.27

# PRESSURE RELIEF VALVE ENGINEERING HANDBOOK

## CHAPTER 5 – VALVE SIZING AND SELECTION – USCS UNITS (UNITED STATES CUSTOMARY SYSTEM)

---

### THE FOLLOWING FIGURES ARE INCLUDED IN THIS CHAPTER:

---

Figure 5-1	Varec Brand Pressure Vent Capacity Chart.....	5.6
Figure 5-2	Closed Simple Rankine Steam Cycle.....	5.7
Figure 5-3	Critical Pressure Ratio for Two-Phase Flow.....	5.20
Figure 5-4	Critical Pressure Ratio for Low Subcooled Region Flashing Liquids.....	5.22
Figure 5-5	ASME Section VIII Appendix 11 – Available Mass Flux - Saturated Water.....	5.25
Figure 5-6	Sound Pressure Level at 100 Feet from Point of Discharge.....	5.26
Figure 5-7	Open Discharge Reaction Force.....	5.27

### THE FOLLOWING TABLES ARE INCLUDED IN THIS CHAPTER:

---

Table 5-1	ASME Section I Drum/Superheater Sizing Example Summary.....	5.9
Table 5-2	ASME Section I Reheater Sizing Example Summary.....	5.10
Table 5-3	Saturated Steam Capacities - Set Pressures 2760 - 3090 psig.....	5.12
Table 5-4	Saturated Steam Capacities: Set Pressures 560 - 1100 psig.....	5.13
Table 5-5	API 520 (ISO 23251)/API 2000 (ISO 28300) Environmental Factor.....	5.14
Table 5-6	API 2000 (ISO 28300) Heat Input.....	5.14
Table 5-7	NFPA 30 Equivalent Air Capacity Requirement.....	5.15
Table 5-8	NFPA 30 Equivalent Air Capacity Requirement (Tanks with Wetted Area > 2800 ft <sup>2</sup> and Design Pressures > 1 psig).....	5.16
Table 5-9	NFPA 58/59A Environmental Factor.....	5.16
Table 5-10	Anderson Greenwood Crosby Recommended Valve Design for Two-Phase Flow....	5.21
Table 5-11	Noise Intensity (at 100 feet from the discharge).....	5.25

## I. INTRODUCTION

---

This section of the Emerson Pressure Relief Valve Engineering Handbook is laid out to assist the user in the sizing and selection of pressure relief valves when system parameters are expressed in United States Customary System (USCS) units. The procedures and equations in this chapter are consistent with the requirements of the ASME Boiler and Pressure Vessel Code and API Recommended Practices and Standards. Please refer to Chapter 6 for sizing using metric unit formulations.

Please visit the Emerson Sizing Website for access to PRV<sup>2</sup>SIZE. The address is [valvesizing.emerson.com](http://valvesizing.emerson.com). This sizing program will perform many of the sizing techniques discussed in this chapter.

### Procedure

Before the determination can be made of the required pressure relief valve orifice area, an in-depth analysis of various overpressure scenarios for the equipment being protected must be completed. API Standard 521 is oftentimes used as a guide to determine what possible causes of overpressure could occur and what subsequent required relieving capacity is necessary to mitigate the system upset. These standards will help the process engineer determine the worst case scenario from unexpected system conditions such as blocked outlets, reflux failures, power failures, overfilling, exchanger tube damage, and external fire. There are many other possible overpressure conditions listed in the standard. API Standard 2000 contains similar information on causes of overpressure and vacuum, and the required relieving capacity for the protection of atmospheric or low pressure storage tanks.

One key piece of information for the sizing of the pressure relief valve is the knowledge of the largest required capacity that results from one of these overpressure conditions. This required capacity is often referred to as the "worst case scenario." This chapter will help you with the sizing techniques to obtain the proper pressure relief valve orifice for this worst case scenario.

It should be noted however, that the final selection of the pressure relief valve type and its materials of construction may be based upon other overpressure contingencies. For example, a worst case scenario may be when a liquid is boiled off into a vapor due to an external fire. A pressure relief valve is sized based upon this vapor flow rate. There may be another overpressure condition where the liquid could overflow and this liquid flow rate requires a smaller orifice. As we learned in Chapter 4, not all pressure relief valve trims designed for vapor flow work well on liquid flow. If the lesser contingency is ignored during the pressure relief device selection, then an improper valve might be installed.

### Pressure Relief Valve Nozzle Coefficient of Discharge

As you review the various orifice sizing formulas in this chapter, you will note that there will almost always be one variable that will be listed as the valve coefficient of discharge. This value is specific to a particular valve design and illustrates the imperfect flow characteristics of the device. The best nozzle coefficient of discharge ( $K_d$ ) would be that of an ideal nozzle. The value of the  $K_d$  is the quotient of the actual measured flow divided by the theoretical flow of an ideal nozzle. Therefore, the  $K_d$  for a particular valve can be no larger than 1.0.

There are various codes and standards that require actual flow tests to be performed to establish the flow efficiency of a pressure relief valve. For example, there are testing procedures described in documents, such as the ASME Boiler and Pressure Vessel Code, ISO 4126, and API 2000, that will establish the  $K_d$  of a particular valve design.

If you look further in either Section I or Section VIII of the ASME Code, there is one procedure where the manufacturer is required to test three valves in three different sizes, for a total of nine tests. The  $K_d$  value for each of these nine tests is calculated and averaged. The requirement is that none of these nine  $K_d$  values can vary any more than plus or minus 5% of the average  $K_d$ .

Most gas or steam certified safety valves that use the nozzle bore as the flow limiting dimension are quite efficient as compared to the ideal nozzle. It is not unusual to have a  $K_d$  value of 0.950 or higher for these valves. The  $K_d$  value for liquid certified relief valves is much lower or in the range of 0.750.

An additional requirement in the ASME Code (both Section I and Section VIII) is to reduce the flow tested  $K_d$  value by 10%. This requirement is also found in ISO 4126. This reduced coefficient provides an additional safety factor when calculating the required flow area for a pressure relief valve. For example, if a safety valve is tested to have a  $K_d$  equal to 0.950 then what is called the "ASME rated" nozzle coefficient of discharge is  $0.950 \times 0.900$  or 0.855. This ASME rated nozzle coefficient is typically denoted as  $K$  ( $K = K_d \times 0.9$ ). The valve sizing formulas outside of the scope of ASME (below 15 psig) will use the actual flow tested  $K_d$  values.

**API Effective vs ASME Section VIII Rated Nozzle Coefficient of Discharge**

The ASME Section VIII rated nozzle coefficient of discharge (K) will vary from one valve design to the other, one service (i.e. compressible versus incompressible) to the other, and one manufacturer to the other. Therefore, if the valve manufacturer and/or the valve design is not yet selected, and a preliminary pressure relief valve size for an ASME Section VIII valve is needed, many users will refer to API Standard 520 part I to obtain what are called effective nozzle coefficients. This recommended practice publishes one common nozzle coefficient of discharge for gases, steam and liquids to be used for preliminary sizing of the flow orifice area.

When selecting the preliminary flow orifice size, API 520 part I will point the user to the API Standard 526. This API 526 standard is where you will find the effective flow orifice sizes for what are more commonly called the "lettered" orifice designations. The scope of the API 526 standard is a 1" x 2" [D orifice designation] through an 8" x 10" [T orifice designation]. The scope of API 526 is limited to flanged direct spring loaded and flanged pilot operated pressure relief valves.

Once the manufacturer and specific design are decided, API 520 part I will instruct the user to recalculate the required flow orifice size using the ASME rated nozzle coefficient of discharge (K). The actual flow orifice area of the valve selected should be compared to meet or exceed the calculated orifice area value.

The API effective coefficient of discharge and effective orifice areas are illustrated with the applicable Anderson Greenwood Crosby models that meet API Standard 526. The direct spring valves are shown in Table 7-6 and the pilot operated valves are shown in Table 7-11. The preliminary sizing per API can be completed using these values. You will note that the information for the effective nozzle coefficients and orifice areas are exactly the same for the two different valve designs.

The ASME rated coefficient of discharge (K) and the actual flow orifice area for these same valve designs are shown in Table 7-7 for the direct spring valves and Table 7-12 for the pilot operated valves. You will now notice the ASME rated coefficient of discharge and actual flow orifice areas are different because these values are specific to the valve design. The user should be aware that the use of the API effective values in sizing these particular Anderson Greenwood Crosby brand products will always be conservative. The recalculation of the required orifice size using rated coefficient of discharge (K) and comparing the answer to the actual orifice area will always allow for the same valve size, or smaller, to that identified in the preliminary API sizing.

*In no case should an api effective coefficient of discharge or effective area be used with the rated coefficient of discharge or actual area to perform any calculation. Sizing errors can be made if the effective values are mixed with the actual values.*

For Anderson Greenwood Crosby valve designs that do not fall within the scope of API 526, such as portable valves, ASME Section I valves, or full bore pilot operated valves, it is suggested to always use the rated coefficient of discharge and actual orifice area for any sizing.

**II. GAS/VAPOR SIZING – SONIC FLOW**

The orifice sizing for vapors or gases can be done either by capacity weight or by volumetric flow rates. The formulas used are based on the perfect gas laws. These laws assume that the gas neither gains nor loses heat (adiabatic), and that the energy of expansion is converted into kinetic energy. However, few gases behave this way and the deviation from the perfect gas laws becomes greater as the gas approaches saturated conditions. Therefore, the sizing equations will contain various correction factors, such as the gas constant (C) and the compressibility factor (Z), that illustrate deviation from the perfect gas law.

**Set Pressures ≥ 15 psig**

The following formulas can be used for sizing valves when the set pressure is at or above 15 psig.

Weight Flow (lb/hr) 
$$A = \frac{W}{CKP_1K_bK_c} \sqrt{\frac{TZ}{M}}$$

Volumetric Flow (scfm) 
$$A = \frac{V \sqrt{MTZ}}{6.32 CKP_1K_bK_c}$$

Where:

- A = Minimum required discharge area, square inches
- C = Gas constant based upon the ratio of specific heats of the gas or vapor at standard conditions. See Chapter 7 Section VI. Use C = 315 if ratio of specific heats is unknown
- K = Coefficient of discharge. See Chapter 7 Section IX
- K<sub>b</sub> = Back pressure correction factor for gas. See Chapter 7 Section II
- K<sub>c</sub> = Combination factor for installations with a rupture disc upstream of the valve. See Chapter 7 Section XI for flow certified factors. Use a 0.9 value for any rupture disc/pressure relief valve combination not listed in Chapter 7 Section XI. Use a 1.0 value when a rupture disc is not installed
- M = Molecular weight of the gas or vapor. See Chapter 7 Section VII for common gases
- P<sub>1</sub> = Relieving pressure, pounds per square inch absolute. This is the set pressure (psig) + overpressure (psig) + atmospheric pressure (psia) – inlet pressure piping loss (psig)
- T = Absolute relieving temperature of the gas or vapor at the valve inlet, degree Rankine (degree Fahrenheit + 460)
- W = Required relieving capacity, pounds per hour (lb/hr)
- V = Required relieving capacity, standard cubic feet per minute (scfm)
- Z = Compressibility factor. See Chapter 7 Section I

**III. GAS/VAPOR SIZING – SUBSONIC FLOW**

**Set Pressures < 15 psig or Vacuum Conditions**

The following formulas can be used for sizing valves when the set pressure is below 15 psig. When pressure relief valves operate on gases or vapors below 15 psig, the speed at which the service fluid travels is always less than the speed of sound or subsonic. Under these conditions, the flow decreases with increasing back pressure as the upstream flowing pressure stays the same.

These equations can be used to size the Anderson Greenwood low pressure pilot operated valves listed in Chapter 7, Tables 7-14 and 7-15.

Weight Flow (lb/hr)

$$A = \frac{W \sqrt{TZ}}{735 K_d P_1 F \sqrt{M}}$$

Volumetric Flow (scfm)

$$A = \frac{V \sqrt{MTZ}}{4645 K_d P_1 F}$$

Where:

$$F = \sqrt{\frac{k}{k-1} \left[ \left( \frac{P_2}{P_1} \right)^{\frac{2}{k}} - \left( \frac{P_2}{P_1} \right)^{\frac{k+1}{k}} \right]}$$

Where:

- A = Minimum required discharge area, square inches
- K<sub>d</sub> = Coefficient of discharge. See Chapter 7 (Tables 7-14 and 7-15)
- k = Specific heat ratio. See Chapter 7 Section VII for common gases
- M = Molecular weight of the gas or vapor. See Chapter 7 Section VII for common gases
- P<sub>1</sub> = Relieving pressure, pounds per square inch absolute. This is the set pressure (psig) + overpressure (psig) + atmospheric pressure (psia) – inlet pressure piping loss (psig)
- P<sub>2</sub> = Pressure at the valve outlet during flow, pounds per square inch absolute. This is the total back pressure (psig) + atmospheric pressure (psia)
- T = Absolute relieving temperature of the gas or vapor at the valve inlet, degree Rankine (degree Fahrenheit + 460)
- W = Required relieving capacity, pounds per hour (lb/hr)
- V = Required relieving capacity, standard cubic feet per minute (scfm)
- Z = Compressibility factor. See Chapter 7 Section I

The flow characteristics for the Varec brand weight loaded pressure and vacuum vents are unique, not only for each model, but also for each size of a particular model. The coefficient of discharge method is different for each of these many combinations and is not easy to select an orifice size with equations. It is suggested to use flow capacity charts from the Varec catalog to manually select the valve size. The example shown in Figure 5-1 below shows the available flow capacity for a vent with a set pressure of 4 inches of water column. One point on this chart shows that a 3 inch vent with 2 inches of water column overpressure (i.e. 6 inches w.c. flowing pressure) will flow 20,000 standard cubic feet of air per hour.

**IV. STEAM SIZING**

**ASME Section VIII (Set Pressures ≥ 15 psig)**

The following formula is used for sizing safety valves for process vessel applications that normally are not considered fired vessels. Examples of fired vessels are economizers, steam drums, superheaters and reheaters that fall under the ASME Section I scope. As discussed in the previous gas/vapor section, the determination of the required steam relieving rate is needed before sizing can begin. Once again the use of API Standard 521 can be helpful to determine the required steam flow due to sources of overpressure such as a split exchanger tube or reflux failures.

This formula is based upon the empirical Napier formula for steam flow. The nozzle coefficient of discharge and the back pressure correction factors are the same as those in the previous gas/vapor section. There is a new factor for steam that is above its saturation temperature, or is in a superheated condition. The more superheated the steam, the greater the required orifice area. A second, but rarely used input, is the Napier equation correction factor. This factor is only used for dry saturated steam when the set pressure is 1500 psia or greater.

$$A = \frac{W}{51.5 K P_1 K_{sh} K_n K_b}$$

Where:

- A = Minimum required discharge area, square inches
- W = Required relieving capacity, (lb/hr)
- K = Coefficient of discharge. See Chapter 7 Section IX
- P<sub>1</sub> = Relieving pressure, pounds per square inch absolute. This is the set pressure (psig) + overpressure (psig) + atmospheric pressure (psia) – inlet pressure piping loss (psig)
- K<sub>sh</sub> = Capacity correction factor due to the degree of superheat in the steam. For saturated steam use 1.0. See Chapter 7 Section V
- K<sub>n</sub> = Capacity correction factor for dry saturated steam at set pressures above 1500 psia. See Chapter 7 Section III
- K<sub>b</sub> = Back pressure correction factor for gas. See Chapter 7 Section II

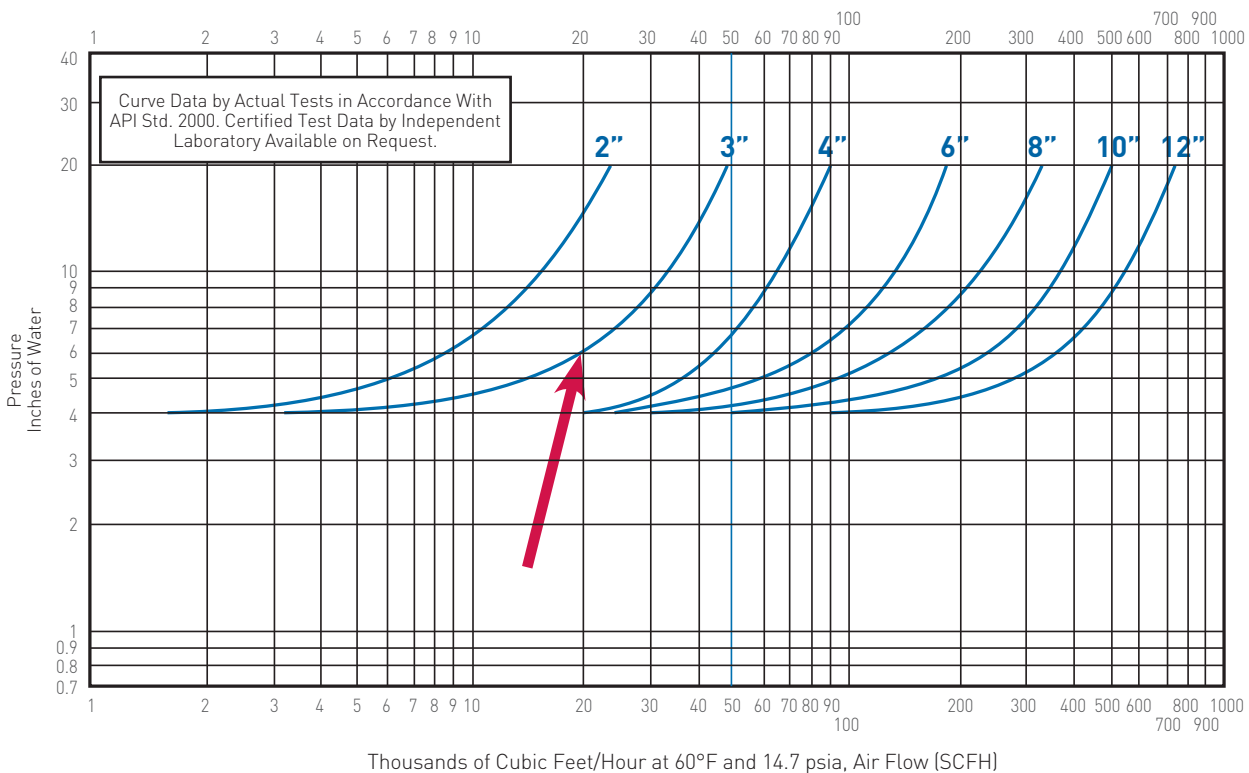


FIGURE 5-1  
 Varec Brand Pressure Vent Capacity Chart

**ASME Section I (Set Pressures ≥ 15 psig)**

The sizing and selection of steam safety valves for fired pressure vessels that fall under the scope of ASME Section I has a different procedure than an ASME Section VIII steam sizing case. The steam sizing equation listed above could be used, but there are certain valve selection rules within ASME Section I where the use of valve capacity charts provides for a simpler procedure.

**Steam drum safety valve sizing**

The steam drum is one such fired pressure vessel that receives the saturated steam from water that has been heated by burning an external fuel source such as coal or natural gas. The boiler system may consist of only this steam drum or may have other vessels used to add heat that we will discuss below. For the purposes of this initial discussion, let us assume the boiler system has only a steam drum. As with the sizing procedures discussed previously, the required steam relieving rate must be determined to size the drum safety valve. This is fairly straight forward as, in most instances, the required capacity shall not be smaller than the maximum designed steaming output of the boiler at its MAWP. The user should refer to the catalog where the saturated steam capacity tables are located. The following link will provide access to the Crosby HL, HSJ, HCI and HE steam safety valves:  
<http://www.valves.emerson.com/valves/Images/CROMC-0295-US.pdf>

or greater of that of the larger valve. Beyond this requirement, there are no other rules on how the overall required capacity is to be divided between multiple valves but it is often found that the capacity be evenly split between the multiple valves. This will allow the valves to be of the same configuration which can optimize the use of spare parts for maintenance.

These same selection rules in Section I apply when the boiler system has additional vessels in its train. However, there are additional requirements to consider that will be discussed next for the superheater, reheater and economizer.

Although the determination of required capacity is often simple, the selection process is more involved as there are rules to be followed in the ASME Section I Code. One such requirement is that if a boiler system has a combined bare tube and extended heating surface exceeding 500 square feet, and a design steaming generation capacity exceeding 4000 lb/hr, then the drum must have two or more safety valves. In these cases where two valves are to be used, there is a requirement in ASME Section I that the relieving capacity of the smaller valve be at least 50%

**Superheater safety valve sizing**

As shown in Figure 5-2, when the steam created in the drum is being used to turn a turbine to create work, the steam drum outlet is often, but not always, attached to a heat exchanger vessel called a superheater. The moisture in saturated steam coming from the drum can cause corrosion and damage to the turbine blades. Therefore, the use of a superheater allows the hot flue gases from the boiler to continue to heat the wet steam to temperatures above saturation thus drying the fluid. The rules in ASME Section I state that all superheaters must have one or more safety valves located on the outlet of the superheater and prior to the first downstream isolation valve. The Code goes further to state that if there are no intervening stop valves between the steam drum and the superheater, then the superheater safety valve can be included in providing the relieving capacity for the entire system. This superheater safety valve, along with the drum valve, will satisfy the Code requirement for multiple valves for the larger boiler systems outlined in the previous steam drum discussion. What changes is the allowable split of the required capacity to be delivered by these multiple valves. ASME Section I mandates that for a boiler system, the drum safety valve provide a minimum of 75% of the available relieving capacity. The reason the Code limits the superheater safety valve available capacity is to protect this exchanger. Damage to the tubes in the exchanger can occur if the incoming saturated steam from the drum

cannot make up the flow from the superheater safety valves that may have opened. The tubes in the superheater can overheat and fatigue because of the lack of heat transfer. This is an important consideration since the superheater valves are set to open before the drum valves because of inlet pressure losses between the upstream drum and the downstream superheater. If an overpressure event occurs, the opening of the safety valves on dry superheated steam is preferable to opening the drum valves on wet steam.

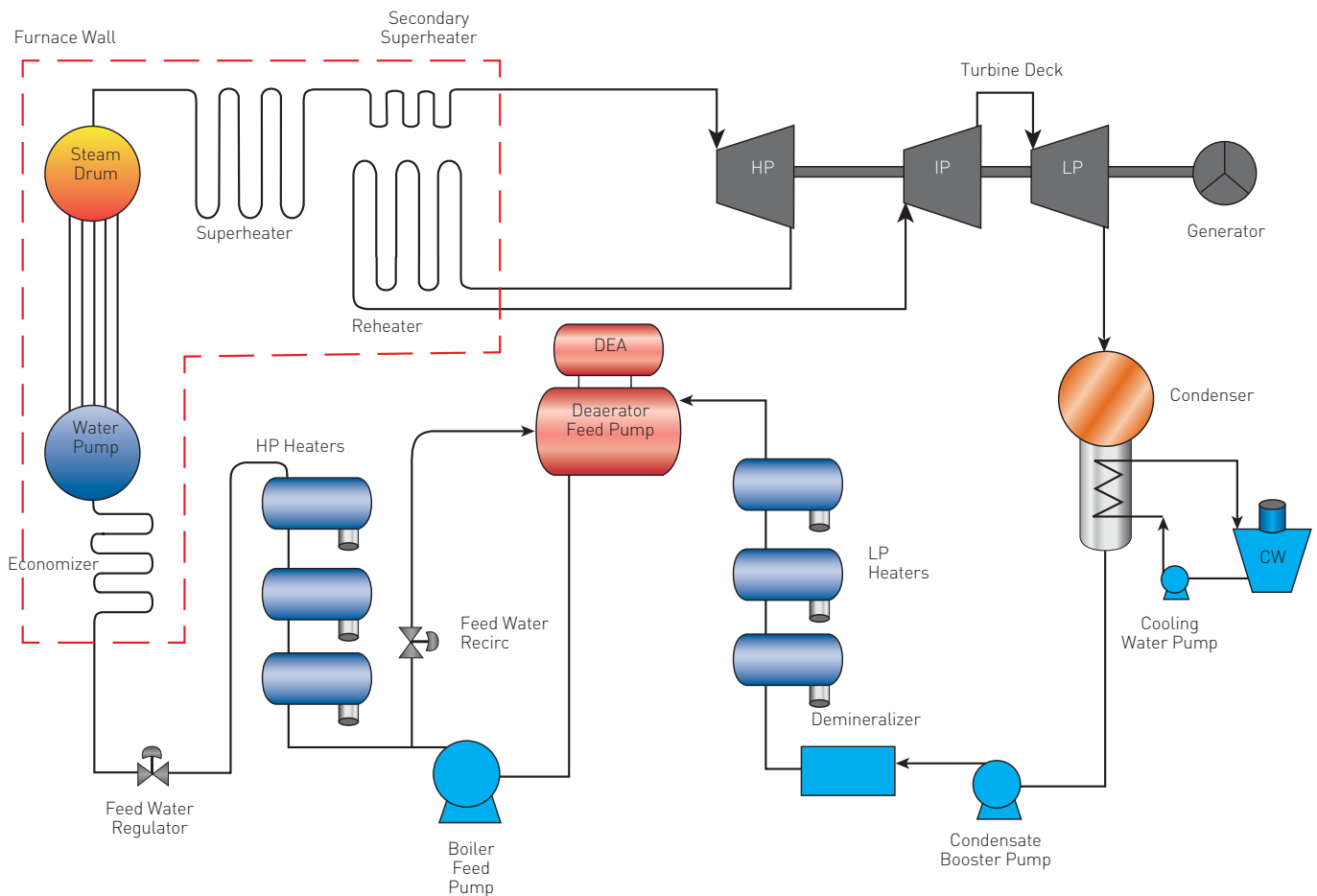


FIGURE 5-2  
 Closed Simple Rankine Steam Cycle



# PRESSURE RELIEF VALVE ENGINEERING HANDBOOK

## CHAPTER 5 – VALVE SIZING AND SELECTION – USCS UNITS (UNITED STATES CUSTOMARY SYSTEM)

---

Emerson engineering recommends the use of multiple steam drum valves when a superheater is part of the boiler system. These multiple drum valves should be set with the staggered values allowed by the Code and selected using the capacity mandate where a smaller orifice valve should have at least 50% or greater capacity of the larger orifice valve. This staged relief of steam pressure can help prevent the ingress of water into the steam trim safety valves during an opening cycle. Please note this two or more drum valve arrangement is not required by the Code but in many instances the required capacity will simply be too large for one safety valve. A sample calculation and selection of drum and superheater safety valves follows:

### Step One

Determine the boiler specifications.

1. Total boiler steam generation: 1,450,000 lb/hr
2. Boiler drum and superheater design pressure (MAWP): 3000 psig
3. Drum operating pressure: 2835 psig
4. Superheater outlet temperature: 1000°F
5. Superheater outlet operating pressure: 2680 psig
6. Boiler system bare tube and extended heating surface exceeds 500 sq.ft.

### Step Two

Determine the capacity of the drum safety valves.

1. A minimum of 75% of the boiling steaming capacity must be relieved from the drum safety valves:  $1,450,000 \text{ lb/hr} \times 0.75 = 1,087,500 \text{ lb/hr}$ .

### Step Three

Select the drum safety valves with primary valve set at the MAWP.

1. Since we have more than 500 square feet of bare tube and heating surface and our steam generation is greater than 4000 lb/hr, Emerson engineering recommends to use a minimum of two drum valves.
2. As you recall, ASME Section I allows for 6% accumulation when multiple valves are used. The first, or primary, valve can be set no higher than MAWP of 3000 psig in this example. The secondary valve can be set 3% higher than MAWP or 3090 psig.
3. As mentioned earlier, it may be preferable, but not required, to have the same size drum valves to facilitate effective use of spare parts. Therefore, for this example we will split the drum capacity evenly between two safety valves:  $1,087,500 \text{ lb/hr} \div 2 = 543,750 \text{ lb/hr}$ .
4. Refer to Crosby Safety Valve catalogs for capacity charts to select the drum safety valves. See Table 5-3 for an example of the Crosby capacity chart. The Crosby HE valve is suitable for drum applications at these set pressures. "M" orifice valves will provide 590,497 lb/hr at 3000 psig set and 619,478 lb/hr at 3090 psig set. It should be noted that the capacity charts will show the capacity in saturated steam already adjusted using the Kn high pressure (1500 psia and above set pressures) factor.

### Step Four

Determine the superheater safety valve set pressure.

1. Subtract the superheater outlet operating pressure from the drum outlet operating pressure to obtain the pressure loss in the piping between these devices:  $2835 \text{ psig} - 2680 \text{ psig} = 155 \text{ psig}$ .
2. As mentioned above, it is desirable to open the superheater safety valve first followed by the drum safety valve if necessary. Emerson engineering recommends that an additional 20 psi be included in the drum to superheater pressure drop to allow this to occur. It should be noted that this 20 psi additional pressure difference is not mandated by the ASME Section I Code. Therefore, the total superheater pressure differential from the drum is the pressure loss plus the Emerson recommended 20 psi factor:  $155 \text{ psig} + 20 \text{ psig} = 175 \text{ psig}$ .
3. Calculate the superheater set pressure by subtracting the total drum to superheater pressure differential from the design (MAWP) pressure:  $3000 \text{ psig} - 175 \text{ psig} = 2825 \text{ psig}$ .

**Step Five**

Determine the superheater safety valve required relieving capacity.

1. The remaining capacity to be provided by the superheater safety valve is the difference between the total steam generation and rated capacity of the drum safety valves that have been selected:  
 $1,450,000 \text{ lb/hr} - 590,497 \text{ lb/hr} - 619,478 \text{ lb/hr} = 240,025 \text{ lb/hr}$ .
2. The superheat correction factor must be determined because the superheater safety valves are operating, and will be flowing, above the saturation point.
  - a. The superheater safety flowing pressure (psia) will be the set point + overpressure + atmospheric:  $2825 \text{ psig} \times 1.03 + 14.7 \text{ psia} = 2924 \text{ psia}$
  - b. At 1000°F and 2924 psia, the superheat correction factor is 0.711 from Chapter 7 Section V
3. In order to use the saturated steam capacity chart in Table 5-3 to select the superheater safety valve, we must convert the remaining required capacity to saturated conditions. Therefore, equivalent saturated steam required capacity at the superheated condition at 1000°F is:  $240,025 \text{ lb/hr} \div 0.711 = 337,588 \text{ lb/hr}$  saturated steam.

**Step Six**

Select the superheater safety valve.

1. Refer to Crosby Safety Valve catalogs for capacity charts to select the superheater safety valve. Again, Table 5-3 provides an example. The Crosby HCl valve is suitable for superheater outlet applications at a set pressure of 2825 psig.
2. From the chart, interpolation will show that a "K2" orifice will provide 381,229 lb/hr of saturated steam and meet the requirement from step five.
3. At the 1000°F superheat condition, this Crosby HCl "K2" orifice valve that has been selected will flow:  $381,229 \text{ lb/hr}$  saturated steam  $\times 0.711 = 271,054 \text{ lb/hr}$  superheated steam.

**Step Seven**

Check to ensure we meet the ASME Section I requirement that drum safety valves flow at least 75% of the total boiler steaming capacity and that the combined relieving capacity of all safety valves meet or exceed the required steaming capacity of the boiler. See Table 5-1 that summarizes the drum and superheater safety valve selection.

Reheater safety valve sizing

In Figure 5-2, there is another heat exchanger, called a reheater, that will add efficiency to the steam cycle by taking spent, near saturated, steam from the turbine and adding more heat from the exhaust gases of the boiler to the spent steam. A closed steam cycle may, or may not, have a reheater.

The reheater operates similar to the superheater exchanger to superheat this incoming spent steam. This superheated steam exiting the reheater is at a much lower pressure than that at the superheater outlet but its temperature is virtually the same. This lower pressure, superheated steam from the reheater outlet is then sent back to the turbine deck where an intermediate pressure turbine will expand the steam and do additional work.

The ASME Section I Code requires each reheater to have one or more safety valves. The overall required capacity must be equal to or greater than the maximum steam flow for which the reheater is designed.

Unlike the superheater safety valves there can be no credit taken for the reheater safety valves capacity in providing protection for the steam drum.

The reheater safety valves can be located either on the reheater inlet line that returns the spent saturated steam back from the high pressure turbine or on the outlet line that delivers superheated steam back to the intermediate pressure turbine. One rule in ASME Section I will state that at least one safety valve be located on the outlet of the reheater prior to the first isolation valve and that this reheater outlet safety valve provide a minimum of 15% of the total required capacity. As with the superheater, this requirement will protect the tubes of the reheater when the safety valves must lift.

Similar to the superheater outlet safety valve, the reheater outlet safety valve is set lower than the reheater inlet valve to allow for the pressure drop through the exchanger and allow for the exhaust of the dry superheated steam to occur first. One might rightly assume it to be a good practice to have 100% of the required relieving capacity be from the reheater outlet valve as there is no restriction in ASME Section I for this type of installation. One reason for not installing the safety valves in this fashion is that these reheater outlet valves are more expensive devices than the reheater inlet valves. This is because the high superheated temperatures on the reheater outlet require a high alloy steel bill of materials so most specifications try and keep this valve as small as possible.

An example of a reheater sizing and selection follows.

**TABLE 5-1 – ASME Section I Drum/Superheater Sizing Example Summary**

Location	Orifice Size	Set Pressure (psig)	Temperature	Rated Relieving Capacity (lb/hr steam)	% of Total Required Capacity (1,450,000 lb/hr)
Low Set Drum Safety Valve	M	3000	Saturated Steam	590,497	
High Set Drum Safety Valve	M	3030	Saturated Steam	619,478	
<b>Total Flow thru Drum Safety Valve</b>				<b>1,209,975</b>	<b>83%</b>
Superheater Outlet Safety Valve	K2	2825	1000°F	271,054	19%
<b>Total Flow thru all Safety Valves</b>				<b>1,481,029</b>	<b>102%</b>

**Step One**

Determine the reheater specifications.

1. Reheater maximum design steam flow: 1,000,000 lb/hr
2. Design pressure: 750 psig
3. Reheater inlet operating pressure: 675 psig
4. Reheater outlet operating pressure: 650 psig
5. Reheater outlet operating temperature: 1000°F

**Step Two**

Determine the reheater outlet safety valve set pressure.

1. Subtract the reheater outlet operating pressure from the reheater inlet operating pressure to obtain the pressure loss between these locations:  $675 - 650 \text{ psig} = 25 \text{ psig}$ .
2. As mentioned above, it is desirable to open the reheater outlet safety valve first followed by the reheater inlet safety valve if necessary. Emerson engineering recommends that an additional 15 psi be included in the pressure drop to allow this to occur. It should be noted that this 15 psi additional pressure difference is not mandated by the ASME Section I Code. Therefore, the total reheater inlet to outlet pressure differential is the pressure loss plus the Emerson recommended 15 psi factor:  $25 \text{ psig} + 15 \text{ psig} = 40 \text{ psig}$ .
3. Calculate the reheater outlet safety valve set pressure by subtracting the reheater pressure differential from the design pressure:  $750 \text{ psig} - 40 \text{ psig} = 710 \text{ psig}$ .

**Step Three**

Determine the capacity of the reheater outlet safety valve.

1. A minimum of 15% of the relieving capacity must come from the reheater outlet safety valve:  $1,000,000 \text{ lb/hr} \times 0.15 = 150,000 \text{ lb/hr}$ .
2. The superheat correction factor must be determined because the reheater outlet safety valves are operating, and will be flowing, above the saturation point.
  - a. The reheater safety valve flowing pressure (psia) will be the set point + overpressure + atmospheric:  $710 \text{ psig} \times 1.03 + 14.7 = 746 \text{ psia}$
  - b. At 1000°F and 746 psia, the superheat correction factor is 0.758 from Chapter 7 Section V
3. In order to use the saturated steam capacity chart such as that shown in Table 5-4 to select the reheater outlet safety valve, we must convert the required capacity to saturated conditions. Therefore, equivalent saturated steam required capacity at the superheated condition at 1000°F is:  $150,000 \text{ lb/hr} \div 0.758 = 197,889 \text{ lb/hr saturated steam}$ .

**Step Four**

Select the reheater outlet safety valve.

1. From Table 5-4 one "P" orifice Crosby HCI safety valve will provide 215,209 lb/hr at 710 psig.
2. At the 1000°F superheat condition this HCI Crosby HCI "P" orifice valve that has been selected will flow:  $215,209 \text{ lb/hr saturated steam} \times 0.758 = 163,128 \text{ lb/hr superheated steam}$ .

**Step Five**

Determine the reheater inlet safety valve required relieving capacity.

1. The remaining capacity to be provided by the reheater inlet safety valves is the difference between the design steam flow and rated capacity of the reheater outlet that has been selected:  $1,000,000 \text{ lb/hr} - 163,128 \text{ lb/hr} = 836,872 \text{ lb/hr}$ .

**Step Six**

1. Refer again to Crosby Safety Valve catalogs (see Table 5-4) for capacity charts to select the reheater inlet safety valves. The Crosby HCI valve is suitable for reheater inlet applications at these set pressures. You will note there is not one valve that can provide the remaining required capacity. Therefore, we need to consider multiple valves. As mentioned previously, many specifying engineers will select identical valves to optimize spare parts.
2. Divide the remaining required capacity for the reheater in half:  $836,872 \text{ lb/hr} \div 2 = 418,436 \text{ lb/hr}$ .
3. As you recall, ASME Section I allows for 6% accumulation when multiple valves are used. The first or primary reheater inlet valve can be set no higher than MAWP of 750 psig in this example. The secondary valve can be set 3% higher than MAWP or 773 psig.
4. "Q2" orifice valves will provide 436,037 lb/hr at 750 psig set and 448,873 lb/hr at 773 psig set.

**TABLE 5-2 – ASME Section I Reheater Sizing Example Summary**

Location	Size	Set Orifice (psig)	Pressure Temperature	Rated Relieving Capacity (lb/hr steam)	% of Total Required Capacity (1,000,000 lb/hr)
Low set reheater inlet safety valve	Q2	750	Saturated Steam	436,037	
High set reheater inlet safety valve	Q2	773	Saturated Steam	448,873	
<b>Total Flow Thru Reheater inlet Safety Valves</b>				<b>884,910</b>	
Reheater Outlet Safety Valve	P	710	1000°F	163,128	16%
<b>Total Flow Thru all Safety Valves</b>				<b>1,048,038</b>	<b>104% of required capacity</b>

**Step Seven**

Check to ensure we meet the ASME Section I requirement that reheater outlet safety valve will flow at least 15% of the total reheater design steam flow, and that the combined relieving capacity of the reheater inlet and reheater outlet safety valves meet or exceed the total steam flow of the reheater. See Table 5-2 that summarizes the reheater inlet and outlet safety valve selection.

**Economizer safety valve sizing**

You will note in Figure 5-2 that there is one other heat exchanger vessel located upstream of the steam drum portion of the steam cycle. As with the superheater and reheater sections of the cycle, hot flue gases are used to add heat to the incoming boiler feedwater. This helps to reduce the amount of energy needed to raise the temperature of the water as it travels to the steam drum.

In many installations there is no intervening isolation valve between the economizer and the steam drum. When this is the case, the safety valves on the steam drum, sized and selected as described above, can be used as overpressure protection for the economizer.

In some steam cycles, such as combined cycle type plants, it may be necessary to regulate the output of the economizer into the boiler to meet varying needs. This requirement now adds valves that could potentially isolate the economizer from the boiler. In this case the ASME Section I Code mandates that the economizer have one or more safety relief valves. The rated capacity of these safety relief valves is determined by the economizer manufacturer based upon the maximum heat absorption rate. For USCS units of measure the heat absorption rate in Btu/hr is divided by 1000 to obtain the required steam capacity in lb/hr. Once again, use the saturated steam tables to select a safety valve that will have a rated capacity equal to or larger than the required capacity.

**V. LIQUID SIZING**

The following formula is used for sizing relief valves for liquid service at any set pressure. The flow of an incompressible fluid (that does not flash) through an orifice is based upon the square root of the differential pressure across that orifice. There is a correction factor for highly viscous liquids as well as a back pressure correction factor for balanced bellows and balanced piston direct acting relief valves.

$$A = \frac{V_L \sqrt{G}}{38KK_V K_W \sqrt{P_1 - P_2}}$$

Where:

- A = Minimum required discharge area, square inches
- V<sub>L</sub> = Required relieving capacity, U.S. gallons per minute at flowing temperature
- K = Coefficient of discharge. See Chapter 7 Section IX
- K<sub>V</sub> = Capacity correction factor due to viscosity of the fluid at flowing conditions. For most applications viscosity will not affect the area calculation so K<sub>V</sub> will be equal to 1.0. See Chapter 7 Section IV for more information
- K<sub>W</sub> = Capacity correction factor for balanced bellows and balanced piston direct acting relief valves due to back pressure. Use K<sub>W</sub> equal to 1.0 for conventional direct spring and pilot operated relief valves. See Figures 7-11, 7-14 and 7-19
- G = Specific gravity of service liquid at flowing temperature referred to water at standard conditions
- P<sub>1</sub> = Inlet pressure during flow, set pressure (psig) + overpressure (psig) – inlet pressure loss (psig)
- P<sub>2</sub> = Total back pressure during flow (psig)

**Thermal relief sizing**

One very common application for a liquid service relief valve is protecting equipment, such as piping from hydraulic expansion of the service fluid. This overpressure contingency is commonly referred to as thermal relief and can be caused by heat transfer from one process media to another or by solar radiation. API Standard 521 states that the required relieving rate is difficult to calculate and that a portable ¾" x 1" valve is very commonly installed to provide protection.

The standard does give some cautions with regards to large diameter liquid pipelines where the distance between isolation devices may be long or where the application deals with liquid filled heat exchangers and vessels. If physical properties are known, the required relieving capacity for thermal relief can be calculated as follows. This flow rate can then be used in the liquid sizing formula above.

$$V_L = \frac{\alpha_v \phi}{500 G c}$$

Where:

- V<sub>L</sub> = U.S. gallons per minute
- α<sub>v</sub> = Cubic expansion coefficient of the trapped liquid at the expected temperature, expressed in 1/°F
- φ = Total heat transfer rate, Btu/h
- G = Specific gravity of service liquid at flowing temperature referred to water at standard conditions
- c = Specific heat capacity of the trapped fluid, Btu/lb-°F

**VI. FIRE SIZING**

One common overpressure contingency to be considered is subjecting a storage tank or process vessel to an external fire that could raise the temperature of the contents in the tank or vessel. This subsequently could increase the system pressure due to a liquid inside the vessel vaporizing or a gas inside the vessel expanding.

# PRESSURE RELIEF VALVE ENGINEERING HANDBOOK

## CHAPTER 5 – VALVE SIZING AND SELECTION – USCS UNITS (UNITED STATES CUSTOMARY SYSTEM)

### Liquid Filled Tanks/Vessels

The procedure that is normally used in determining the required relieving capacity will directly or indirectly calculate the estimated heat transfer from an external fire to the contents of the vessel. This calculated heat input value will vary from one code, standard, recommended practice, or statute to another. One reason for this difference in heat input values is that one particular publication may have a different definition to another for what is called the “wetted” surface area of the vessel exposed to the fire. There are also different assumptions made in the documents with regard to tank insulation, prompt fire fighting availability and drainage that can also alter the heat input calculations.

The exposed wetted surface is that part of the vessel or tank where the liquid contents reside and where a fire can input heat to vaporize the contents. The greater the exposed wetted surface area the greater the heat input, the greater the heat input the more vaporization can occur, the more vaporization the larger the required relief device orifice.

Since this exposed wetted surface definition and various assumptions as noted above can vary from one engineering practice to another, it is important that the user be aware of what document is to be referenced

for a particular installation and location. Some of the more common documents that are referenced and their calculation of exposed wetted surface area, required capacity, and required orifice area are as follows. It is recommended to review these documents, in full, for their scope of use and a more complete explanation of the assumptions made in providing this guidance.

### SATURATED STEAM CAPACITIES: STYLES HE, HCI AND HSJ - USCS (UNITED STATES CUSTOMARY SYSTEM) UNITS

Pounds per hour at 3% overpressure

TABLE 5-3 – Saturated Steam Capacities - Set Pressures 2760-3090 psig

Orifice Designation and Area (sq. in.)																			
HE																			
HCI																			
HSJ																			
Orifice (sq in)(psig)																			
Set Pres.	F 0.307	G 0.503	H 0.785	H2 0.994	J 1.288	J2 1.431	K 1.840	K2 2.545	L 2.853	L2 3.341	M 3.60	M2 3.976	N 4.341	P 6.38	P2 7.07	Q 11.045	Q2 12.25	R 16.00	RR 19.29
2760	-	-	-	144025	-	207344	266606	368757	-	484093	521620	576101	-	-	1024404	-	-	-	-
2770	-	-	-	144763	-	208406	267971	370645	-	486572	524292	579051	-	-	1029651	-	-	-	-
2780	-	-	-	145505	-	209474	269344	372544	-	489065	526978	582018	-	-	1034927	-	-	-	-
2790	-	-	-	146251	-	210548	270725	374454	-	491572	529680	585002	-	-	1040232	-	-	-	-
2800	-	-	-	147001	-	211628	272114	376375	-	494094	532397	588003	-	-	1045569	-	-	-	-
2810	-	-	-	147755	-	212714	273511	378307	-	496631	535130	591022	-	-	1050936	-	-	-	-
2820	-	-	-	148515	-	213807	274916	<b>380251</b>	-	499182	537880	594058	-	-	1056336	-	-	-	-
2830	-	-	-	149278	-	214906	276330	<b>382206</b>	-	501749	540645	597113	-	-	1061767	-	-	-	-
2840	-	-	-	150046	-	216012	277752	384173	-	504331	543428	600186	-	-	1067231	-	-	-	-
2850	-	-	-	150819	-	217125	279183	386152	-	506929	546227	603277	-	-	1072729	-	-	-	-
2860	-	-	-	151597	-	218245	280622	388143	-	509543	549044	606388	-	-	1078261	-	-	-	-
2870	-	-	-	152380	-	219372	282071	390147	-	512174	551878	609519	-	-	1083827	-	-	-	-
2880	-	-	-	153167	-	220505	283529	392164	-	514821	554731	612669	-	-	1089429	-	-	-	-
2890	-	-	-	153960	-	221647	284996	394193	-	517485	557601	615840	-	-	1095067	-	-	-	-
2900	-	-	-	154758	-	222795	286473	396236	-	520167	560491	619031	-	-	1100742	-	-	-	-
2910	-	-	-	155561	-	223951	287960	398292	-	522866	563399	622243	-	-	1106454	-	-	-	-
2920	-	-	-	156369	-	225115	289456	400362	-	525583	566327	625477	-	-	1112204	-	-	-	-
2930	-	-	-	157183	-	226287	290963	402446	-	528319	569275	628733	-	-	1117993	-	-	-	-
2940	-	-	-	158003	-	227467	292480	404544	-	531073	572243	632011	-	-	1123822	-	-	-	-
2950	-	-	-	158828	-	228654	294007	406657	-	533847	575231	635311	-	-	1129691	-	-	-	-
2960	-	-	-	159659	-	229851	295545	408784	-	536640	578241	638635	-	-	1135601	-	-	-	-
2970	-	-	-	160496	-	231055	297094	410927	-	539452	581272	641982	-	-	1141553	-	-	-	-
2980	-	-	-	161338	-	232269	298655	413085	-	542285	584324	645354	-	-	1147548	-	-	-	-
2990	-	-	-	162187	-	233491	300226	415259	-	545139	587399	648750	-	-	1153587	-	-	-	-
3000	-	-	-	163043	-	234722	301809	417448	-	548014	<b>590497</b>	652171	-	-	1159670	-	-	-	-
3010	-	-	-	-	-	-	303405	419655	-	-	593618	655618	-	-	1165799	-	-	-	-
3020	-	-	-	-	-	-	305012	421878	-	-	596762	659091	-	-	1171974	-	-	-	-
3030	-	-	-	-	-	-	306631	424118	-	-	599931	662590	-	-	1178197	-	-	-	-
3040	-	-	-	-	-	-	308263	426375	-	-	603124	666117	-	-	1184468	-	-	-	-
3050	-	-	-	-	-	-	309908	428650	-	-	606342	669671	-	-	1190789	-	-	-	-
3060	-	-	-	-	-	-	311566	430944	-	-	609586	673254	-	-	1197160	-	-	-	-
3070	-	-	-	-	-	-	313238	433256	-	-	612857	676866	-	-	1203582	-	-	-	-
3080	-	-	-	-	-	-	314923	435586	-	-	616154	680508	-	-	1210057	-	-	-	-
3090	-	-	-	-	-	-	316622	437937	-	-	<b>619478</b>	684179	-	-	1216586	-	-	-	-

PRESSURE RELIEF VALVE ENGINEERING HANDBOOK  
 CHAPTER 5 – VALVE SIZING AND SELECTION – USCS UNITS (UNITED STATES CUSTOMARY SYSTEM)

**SATURATED STEAM CAPACITIES: STYLES HE, HCI AND HSJ - USCS (UNITED STATES CUSTOMARY SYSTEM) UNITS**

Pounds per hour at 3% overpressure

**TABLE 5-4 – Saturated Steam Capacities - Set Pressures 560-1100 psig**

		Orifice Designation and Area (sq. in.)																	
HE		• • • • •																	
HCI																			
HSJ																			
		Orifice (sq in)(psig)																	
Set	F	G	H	H2	J	J2	K	K2	L	L2	M	M <sup>2</sup>	N	P	P2	Q	Q2	R	RR
Pres.	0.307	0.503	0.785	0.994	1.288	1.431	1.840	2.545	2.853	3.341	3.60	3.976	4.341	6.38	7.07	11.045	12.25	16.00	19.29
560	8211	13453	20995	26585	34449	38273	49212	68068	76306	89358	96285	106342	116104	170639	189093	295408	327637	427934	515928
570	8354	13687	21361	27048	35049	38940	50069	69253	77635	90914	97962	108193	118126	173610	192386	300552	333342	435385	524912
580	8497	13922	21727	27511	35648	39606	50926	70439	78963	92470	99638	110045	120147	176581	195679	305696	339047	442837	533896
590	8640	14156	22092	27974	36248	40273	51783	71624	80292	94026	101315	111897	122169	179553	198971	310840	344752	450289	542880
600	8783	14390	22458	28437	36848	40939	52640	72809	81621	95582	102992	113749	124191	182524	202264	315984	350458	457741	551864
610	8926	14624	22824	28900	37448	41606	53497	73995	82950	97138	104668	115600	126213	185496	205557	-	356163	465192	560848
620	9069	14859	23189	29363	38048	42272	54354	75180	84278	98694	106345	117452	128234	188467	208850	-	361868	472644	569832
630	9212	15093	23555	29826	38648	42939	55211	76365	85607	100250	108022	119304	130256	191438	212142	-	367574	480096	578816
640	9355	15327	23920	30289	39248	43605	56068	77551	86936	101806	109698	121156	132278	194410	215435	-	373279	487548	587800
650	9498	15562	24286	30752	39847	44272	56925	78736	88265	103362	111375	123007	134300	197381	218728	-	378984	495000	596784
660	9641	15796	24652	31215	40447	44938	57782	79921	89593	104918	113052	124859	136321	200352	222021	-	384689	502451	605768
670	9784	16030	25017	31678	41047	45604	58639	81106	90922	106474	114728	126711	138343	203324	225313	-	390395	509903	614752
680	9927	16264	25383	32141	41647	46271	59496	82292	92251	108030	116405	128563	140365	206295	228606	-	396100	517355	623736
690	10070	16499	25748	32604	42247	46937	60353	83477	93580	109586	118081	130414	142387	209267	231899	-	401805	524807	632720
700	10213	16733	26114	33067	42847	47604	61210	84662	94908	111142	119758	132266	144408	212238	235192	-	407510	532258	641704
710	10356	16967	26480	33529	43447	48270	62067	85848	96237	112698	121435	134118	146430	215209	238484	-	413216	539710	650688
720	10499	17201	26845	33992	44047	48937	62924	87033	97566	114254	123111	135970	148452	218181	241777	-	418921	547162	659672
730	10642	17436	27211	34455	44646	49603	63781	88218	98895	115810	124788	137821	150474	221152	245070	-	424626	554614	668656
740	10785	17670	27576	34918	45246	50270	64638	89404	100223	117366	126465	139673	152495	224124	248363	-	430331	562065	677640
750	10928	17904	27942	35381	45846	50936	65494	90589	101552	118922	128141	141525	154517	227095	251655	-	436037	569517	686624
760	11071	18138	28308	35844	46446	51603	66351	91774	102881	120478	129818	143377	156539	230066	254948	-	441742	576969	695608
770	11214	18373	28673	36307	47046	52269	67208	92959	104210	122034	131495	145229	158561	233038	258241	-	447447	584421	704592
780	11357	18607	29039	36770	47646	52936	68065	94145	105538	123590	133171	147080	160582	236009	261534	-	453152	591872	713576
790	11500	18841	29404	37233	48246	53602	68922	95330	106867	125146	134848	148932	162604	238981	264826	-	458858	599324	722560
800	11643	19076	29770	37696	48845	54269	69779	96515	108196	126702	136525	150784	164626	241952	268119	-	464563	606776	731544
810	11785	19310	30136	38159	49445	54935	70636	97701	109524	128258	138201	152636	166648	244923	271412	-	470268	614228	740528
820	11928	19544	30501	38622	50045	55601	71493	98886	110853	129814	139878	154487	168669	247895	274705	-	475973	621679	749512
830	12071	19778	30867	39085	50645	56268	72350	100071	112182	131370	141555	156339	170691	250866	277997	-	481679	629131	758496
840	12214	20013	31232	39548	51245	56934	73207	101256	113511	132926	143231	158191	172713	253837	281290	-	487384	636583	767480
850	12357	20247	31598	40011	51845	57601	74064	102442	114839	134483	144908	160043	174735	256809	284583	-	493089	644035	776464
860	12500	20481	31964	40474	52445	58267	74921	103627	116168	136039	146584	161894	176756	259780	287876	-	498794	651487	785448
870	12643	20715	32329	40937	53045	58934	75778	104812	117497	137595	148261	163746	178778	262752	291168	-	504500	658938	794432
880	12786	20950	32695	41399	53644	59600	76635	105998	118826	139151	149938	165598	180800	265723	294461	-	510205	666390	803417
890	12929	21184	33060	41862	54244	60267	77492	107183	120154	140707	151614	167450	182822	268694	297754	-	515910	673842	812401
900	13072	21418	33426	42325	54844	60933	78349	108368	121483	142263	153291	169301	184843	271666	301047	-	521615	681294	821385
910	13215	21652	33792	42788	55444	61600	79206	109554	-	143819	-	171153	-	-	304339	-	527321	688745	-
920	13358	21887	34157	43251	56044	62266	80063	110739	-	145375	-	173005	-	-	307632	-	533026	696197	-
930	13501	22121	34523	43714	56644	62933	80920	111924	-	146931	-	174857	-	-	310925	-	538731	703649	-
940	13644	22355	34888	44177	57244	63599	81777	113109	-	148487	-	176709	-	-	314218	-	544436	711101	-
950	13787	22589	35254	44640	57843	64266	82634	114295	-	150043	-	178560	-	-	317510	-	550142	718552	-
960	13930	22824	35620	45103	58443	64932	83490	115480	-	151599	-	180412	-	-	320803	-	555847	726004	-
970	14073	23058	35985	45566	59043	65598	84347	116665	-	153155	-	182264	-	-	324096	-	561552	733456	-
980	14216	23292	36351	46029	59643	66265	85204	117851	-	154711	-	184116	-	-	327389	-	567257	740908	-
990	14359	23527	36716	46492	60243	66931	86061	119036	-	156267	-	185967	-	-	330681	-	572963	748359	-
1000	14502	23761	37082	46955	60843	67598	86918	120221	-	157823	-	187819	-	-	333974	-	578668	755811	-
1010	14645	23995	37448	47418	61443	68264	87775	121407	-	159379	-	189671	-	-	337267	-	584373	763263	-
1020	14788	24229	37813	47881	62043	68931	88632	122592	-	160935	-	191523	-	-	340560	-	590078	770715	-
1030	14931	24464	38179	48344	62642	69597	89489	123777	-	162491	-	193374	-	-	343852	-	595784	778166	-
1040	15074	24698	38544	48807	63242	70264	90346	124962	-	164047	-	195226	-	-	347145	-	601489	785618	-
1050	15217	24932	38910	49269	63842	70930	91203	126148	-	165603	-	197078	-	-	350438	-	607194	793070	-
1060	15360	25166	39276	49732	64442	71597	92060	127333	-	167159	-	198930	-	-	353731	-	612899	800522	-
1070	15503	25401	39641	50195	65042	72263	92917	128518	-	168715	-	200781	-	-	357023	-	618605	807974	-
1080	15646	25635	40007	50658	65642	72930	93774	129704	-	170271	-	202633	-	-	360316	-	624310	815425	-
1090	15789	25869	40372	51121	66242	73596	94631	130889	-	171827	-	204485	-	-	363609	-	630015	822877	-
1100	15932	26103	40738	51584	66841	74263	95488	132074	-	173383	-	206337	-	-	366902	-	635720	830329	-

**API Standard 521 – Pressure Relieving and Depressuring Systems**

**Step One**

Calculate the wetted surface area.

- Liquid Filled Vessels – calculate the wetted area as the exposed area of the vessel up to a maximum height of 25 feet from the location of the fire
- Process Vessels – calculate the wetted area as the exposed area up to the normal liquid operating level. If the normal operating level exceeds 25 feet from the location of the fire, use 25 feet as the height for the wetted area calculation
- Spheres – calculate the exposed area up to the maximum horizontal diameter (i.e. the equator) of the sphere and then calculate the exposed area up to a height of 25 feet from the location of the fire. Use the larger of the two areas as the wetted area

**Step Two**

Calculate the heat absorption or input to the liquid.

- If there is deemed to be prompt firefighting and drainage of the flammable fuel of the fire away from the vessel, use the following equation:

$$Q = 21,000 F A_w^{0,82}$$

Where:

- Q = Total heat absorption (input) to the wetted surface (Btu/h)
- F = Environmental factor (see Table 5-5)
- A<sub>w</sub> = Wetted surface area from step one above, square feet

**TABLE 5-5 – API 520/API 2000 ENVIRONMENTAL FACTOR**

Equipment Type	Factor F <sup>1</sup>
Bare Vessel	1.0
Insulated Vessel <sup>2</sup> (These arbitrary insulation conductance values are shown as examples and are in BTU's per hour per square foot per degree Fahrenheit):	
4	0.3
2	0.15
1	0.075
0.67	0.05
0.50	0.0376
0.40	0.03
0.33	0.026
Water application facilities, on bare vessels	1.0
Depressurizing and emptying facilities	1.0

**NOTES**

- 1 All values are based upon assumptions listed in the API documents. Review these documents for details.
- 2 Insulation shall resist dislodgement by fire hose streams. Reference the API documents for details.

- If there is not prompt firefighting and not drainage of the flammable fuel of the fire away from the vessel, use the following equation:

$$Q = 34,500 F A_w^{0,82}$$

Where:

- Q = Total heat absorption (input) to the wetted surface (Btu/h)
- F = Environmental factor (see Table 5-5)
- A<sub>w</sub> = Wetted surface area from step one above, square feet

**Step Three**

Determine the required relieving capacity.

$$W = \frac{Q}{L}$$

Where:

- Q = Total heat absorption (input) to the wetted surface, from step two above, Btu/h
- L = Latent heat of vaporization, Btu/lb
- W = Required relieving capacity, lb/hr

**Step Four**

Since the primary scope of API 521 is for applications at or above 15 psig design pressures, size for the required orifice using the weight flow vapor equation from page 5.4.

Weight Flow (lb/hr)

$$A = \frac{W}{CKP_1 K_b K_c} \sqrt{\frac{TZ}{M}}$$

Use the physical properties of the service fluid in the equation. Please recall that for ASME Section VIII vessels, the overpressure for fire sizing can be 21% if the valve is set at the MAWP.

**API Standard 2000 – Venting of Atmospheric and Low Pressure Storage Tanks**

**Step One**

Calculate the wetted surface area.

- Spheres – calculate an area of 55% of the total exposed spherical area and then calculate the exposed area up to a height of 30 feet above grade. Use the larger of the two areas as the wetted area.
- Horizontal Tank – calculate an area of 75% of the total exposed area and then calculate the exposed area up to a height of 30 feet above grade. Use the larger of the two areas as the wetted area.
- Vertical Tank – calculate the wetted area as the exposed area up to a height of 30 feet above grade.

**Step Two**

Calculate the heat absorption or input to the liquid per Table 5-6. The formula used for this calculation will vary based upon the wetted surface area calculated in step one.

**TABLE 5-6 – API 2000 HEAT INPUT**

Wetted Surface Area, $A_w$ (ft <sup>2</sup> )	Design Pressure (psig)	Heat Input, Q (BTU/h)
< 200	≤ 15	20,000 $A_w$
≥ 200 and < 1000	≤ 15	199,300 $A_w^{0.566}$
≥ 1000 and < 2800	≤ 15	963,400 $A_w^{0.338}$
≥ 2800	Between 1 and 15	21,000 $A_w^{0.82}$
≥ 2800	≤ 1	14,090,000

Where:

- $A_w$  = wetted surface area from step one above, square feet
- Q = total heat absorption (input) to the wetted surface (Btu/h)

**Step Three**

Calculate the required venting capacity in SCFH of equivalent air capacity using the following formula:

$$q = \frac{3.091QF}{L} \sqrt{\frac{T}{M}}$$

Where:

- q = Required relieving capacity in equivalent air, SCFH.
- Q = Total heat absorption (input) to the wetted surface from step two, Btu/h
- F = Environmental factor (see Table 5-5)
- L = Latent heat of vaporization, Btu/lb
- T = Absolute temperature of the relieving vapor, °R
- M = Molecular weight of the relieving vapor

**Step Four**

API 2000 deals with storage tanks with design pressures less than 15 psig. Therefore, the equivalent air capacity in SCFH calculated in step three can be directly used in the Varec flow capacity charts to select the vent size. For Anderson Greenwood brand pilot operated valves, use the subsonic formula and inputs as discussed on page 5.5.

Volumetric Flow (scfm)

$$A = \frac{V \sqrt{MTZ}}{12,515K_d P_1 F}$$

Note that the capacity calculated in step three is SCFH of equivalent air. The volumetric flow equation uses SCFM. Since the capacity is in equivalent air, use  $M = 29$ ,  $T = 60 + 460 = 520^\circ\text{R}$ ,  $Z = 1.0$  and  $V = q/60$  in the volumetric formula. Note that F in the volumetric flow equation is the flow factor and NOT the environmental factor from Table 5-5.



**NFPA 30 – Flammable and Combustible Liquids Code**

**Step One**

Calculate the wetted surface area.

- Spheres – calculate the wetted area by taking 55% of the total exposed spherical area.
- Horizontal Tank – calculate the wetted area by taking 75% of the total exposed area of the horizontal tank.
- Rectangular Tank – calculate the wetted area by taking 100% of the total exposed shell and floor area of the tank (exclude the top surface of the tank).
- Vertical Tank – calculate the wetted area as the exposed area up to a height of 30 feet above grade.

**Step Two**

Determine the required equivalent air capacity based upon the following criteria. This criteria and tables are similar, but not exact, to an acceptable, but less accurate sizing procedure available for use to meet API 2000.

- For tank design pressures equal to 1 psig and below interpolate in Table 5-7 for the equivalent air capacity in SCFH. Use 742,000 SCFH for any storage tank with a wetted surface area greater than 2800 square feet.

**TABLE 5-7 – NFPA 30 EQUIVALENT AIR CAPACITY REQUIREMENT**

A <sub>WET</sub> (ft <sup>2</sup> )	V (SCFH)	AWET(ft <sup>2</sup> )	V (SCFH)
0	0	350	288,000
20	21,100	400	312,000
30	31,600	500	354,000
40	42,100	600	392,000
50	52,700	700	428,000
60	63,200	800	462,000
70	73,700	900	493,000
80	84,200	1,000	524,000
90	94,800	1,200	557,000
100	105,000	1,400	587,000
120	126,000	1,600	614,000
140	147,000	1,800	639,000
160	168,000	2,000	662,000
180	190,000	2,400	704,000
200	211,000	2,800	742,000
250	239,000	>2,800	-
300	265,000		

- For tank design pressures greater than 1 psig with a wetted surface area of 2800 square feet or less use Table 5-7 for the equivalent air capacity in SCFH.
- For tank design pressures greater than 1 psig with a wetted surface area of 2800 square feet or more
  - Calculate the equivalent air capacity as follows:

$$q = 1107 A_w^{0,82}$$

Where:

- q = required relieving capacity in equivalent air, SCFH
- A<sub>w</sub> = wetted surface area from step one above, square feet.
  - Compare calculated equivalent air capacity to interpolated value from Table 5-8.

**TABLE 5-8 – NFPA 30 EQUIVALENT AIR CAPACITY REQUIREMENT (Tanks with Wetted Area > 2800 ft<sup>2</sup> and Design Pressures > 1 psig)**

Wetted Area (ft <sup>2</sup> )	Equiv Air (SCFH)	Wetted Area (ft <sup>2</sup> )	Equiv Air (SCFH)
2800	742,000	9000	1,930,000
3000	786,000	10,000	2,110,000
3500	892,000	15,000	2,940,000
4000	995,000	20,000	3,720,000
4500	1,100,000	25,000	4,470,000
5000	1,250,000	30,000	5,190,000
6000	1,390,000	25,000	5,900,000
7000	1,570,000	40,000	6,570,000
8000	1,760,000		

– Use the larger of the calculated or interpolated equivalent air capacity as the required relieving rate.

**Step Three**

Note that NFPA 30 may allow a reduction factor to be applied to the required equivalent air capacity (similar to the F factor in other practices) for drainage, water spray systems and insulation. Refer to the publication for details.

**Step Four**

NFPA 30 deals with storage tanks with design pressures less than 15 psig. Therefore, the equivalent air capacity in SCFH calculated in step two can be directly used in the Varec flow capacity charts to select the vent size. For Anderson Greenwood brand pilot operated valves, use the subsonic formula and inputs as discussed on page 5.5.

Volumetric Flow (scfm)

$$A = \frac{V \sqrt{MTZ}}{12,515 K_d P_1 F}$$

Note that the capacity calculated in step two is SCFH of equivalent air. The volumetric flow equation uses SCFM. Since the capacity is in equivalent air, use M = 29, T = 60 + 460 = 520°R, Z = 1.0 and V = q/60 in the volumetric formula. Note that F in the volumetric flow equation is the flow factor and NOT the environmental factor from Table 5-5.

**NFPA 58 – Liquefied Petroleum Gas Code and NFPA 59A – Standard for the Production, Storage and Handling of Liquefied Natural Gas (LNG)**

**Step One**

Calculate the wetted surface area

- All Vessels – calculate the wetted area as the exposed area of the vessel up to a maximum height of 30 feet above grade.

**Step Two**

Calculate the heat absorption or input to the liquid.

$$Q = 34,500 F A_W^{0.82} + H_n$$

Where:

- Q = Total heat absorption (input) to the wetted surface, Btu/h
- F = Environmental factor (see Table 5-9)
- A<sub>w</sub> = Wetted surface area from step one above, square feet
- H<sub>n</sub> = Normal heat leak (refrigerated tanks), Btu/lb

**Step Three**

Determine the rate of vaporization from the liquid for the required relieving capacity.

$$W = \frac{Q}{L}$$

Where:

- W = Required relieving capacity, lb/hr
- L = Latent heat of vaporization, Btu/lb
- Q = Total heat absorption (input) to wetted surface from step two, Btu/h

**TABLE 5-9 – NFPA58/59A ENVIRONMENTAL FACTOR**

Basis	F Factor
Base Container	1.0
Water Application Facilities	1.0
Depressuring Facilities	1.0
Underground Container	0.0
Insulation Factor	$F = \frac{U(1660 - T_f)}{34,500}$

**Note:** U is the heat transfer coefficient Btu/(hr x ft<sup>2</sup> x °F) of the insulation using the mean value for the temperature range from T<sub>f</sub> to +1660F. T<sub>f</sub> is the temperature of the vessel content at relieving conditions (°F). The insulation should not be dislodged by fire hose streams nor be combustible or decompose below 1000°F.

**Step Four**

Calculate the required venting capacity in SCFH of equivalent air capacity using the following formula:

$$q = \frac{3.09W \sqrt{TZ}}{\sqrt{M}}$$

Where:

- q = Required relieving capacity in equivalent air, SCFH
- W = Required relieving capacity of the service fluid from step three, lb/hr
- T = Absolute temperature of the relieving vapor, °R
- M = Molecular weight of the relieving vapor
- Z = Compressibility factor of the relieving vapor

**Step Five**

NFPA 58 and 59A deals with containers or vessels with design pressures above and below 15 psig

- For sonic flow (15 psig and above) use the sonic volumetric sizing formula discussed on page 5.4.

Volumetric Flow (scfm)

$$A = \frac{V \sqrt{MTZ}}{6.32 CK P_1 K_b K_c}$$

- For subsonic flow (below 15 psig) one can directly use the equivalent air capacity in SCFH in the Varc flow capacity charts to select the vent size. For Anderson Greenwood pilot operated valves, use the subsonic volumetric sizing formula discussed on page 5.5.

Volumetric Flow (scfm)

$$A = \frac{V \sqrt{MTZ}}{12,515 K_d P_1 F}$$

Note that the capacity calculated in step four is SCFH of equivalent air. The volumetric flow equation uses SCFM. Since the capacity is in equivalent air, use M = 29, T = 60 + 460 = 520°R, Z = 1.0 and V = q/60 in the volumetric formula. Note that F in the volumetric flow equation is the flow factor and NOT the environmental factor from Table 5-9.

**Gas Filled Vessels**

API Standard 521 provides a recommended procedure for determining the required pressure relief valve area due to a gas filled vessel being exposed to external flames.

**Step One**

Calculate the total exposed surface area. This is the complete surface area of the gas filled vessel that is exposed to the ambient.

**Step Two**

Calculate what is termed the vapor fire sizing factor using the following:

$$F' = \frac{0.1406}{CK} \left[ \frac{(T_w - T_1)^{1.25}}{T_1^{0.6506}} \right]$$

Where:

C = Gas constant based upon the ratio of specific heats of the gas or vapor at standard conditions. See Chapter 7 Section VI. Use C = 315 if ratio of specific heats is unknown

K = Coefficient of discharge. See Chapter 7 Section IX

T<sub>w</sub> = Recommended maximum wall temperature of vessel material, °R

T<sub>1</sub> = Gas temperature at the upstream relieving pressure, °R

This gas temperature can be found using

$$T_1 = \frac{P_1}{P_n} T_n$$

Where:

P<sub>1</sub> = the upstream relieving pressure, set pressure + overpressure + atmospheric pressure, psia – inlet pressure piping loss (psia)

P<sub>n</sub> = the normal operating gas pressure, psia

T<sub>n</sub> = the normal operating gas temperature, °R

*If the calculated value of F' is less than 0.01, then use a recommended minimum value of F' = 0.01.*

*If insufficient data exists to calculate the F', use F' = 0.045*

**Step Three**

Calculate the minimum required pressure relief valve discharge area using:

$$A = \frac{F' A_w}{\sqrt{P_1}}$$

Where,

A = Minimum required discharge area, square inches

A<sub>w</sub> = Total exposed surface area from step one, square feet

P<sub>1</sub> = Upstream relieving pressure, set pressure + overpressure + atmospheric pressure, psia – inlet pressure piping loss (psia)

F' = Vapor fire sizing factor from step two

This equation in step three does not account for any insulation. Credit for insulation may be taken per Table 5-5.

**VII. TWO-PHASE FLOW SIZING**

Two-phase flow describes a condition whereby a flow stream contains a fluid whose physical state is part liquid and part gas. For pressure relief applications it can be common for all or part of the liquid portion of the fluid to change to vapor, or flash, as the pressure drops. The ratio of gas to liquid in the flowing media can be a significant factor in determining the required orifice flow area of a pressure relief valve.

It is important to note that there are no codes such as ASME, that require a certain methodology to be used to size PRVs for two-phase flow regimes. The selection of the method for a particular case lies solely with the user that has the full knowledge of the process conditions.

There are several publications, written by various process relief experts, that will provide guidance in calculating the required relief load and the subsequent minimum required orifice area of the pressure relief valve.

What is evident from these publications is that the subject is complex and that there is no single universally accepted calculation method that will handle every application. Some methods give what are considered to be accurate results over certain ranges of fluid quality, temperature and pressure. The inlet and outlet conditions of the pressure relief valve must be considered in more detail than what has been discussed up to now, where we have been dealing with a single phase fluid flow that does not change state.

It is therefore necessary that those responsible for the selection of pressure relief valves used for two-phase or flashing flow applications be knowledgeable of the total system and current on the latest best practices for multi-phase sizing techniques. The user should note that some of these sizing methods have not been substantiated by actual tests and there is no universally recognized procedure for certifying pressure relief valve capacities in two-phase flows.

This engineering handbook will discuss two of these sizing techniques. One is outlined in API 520 Part I (9th Edition – July 2014) Annex C and the other, from ASME Section VIII Appendix 11, which is specifically used for saturated water applications.

**API Standard 520 Part I (9th Edition)**

One sizing procedure in Annex C is a part of what is commonly known as the “Omega Method” which was developed by Dr. J. Leung. The Omega Method is a simplified version of a more rigorous procedure called the Homogeneous Equilibrium Method (HEM) which assumes that the fluid is well mixed, and the gas and liquid portions of the fluid are flowing at the same velocity through the nozzle of the pressure relief valve. The fluid is also assumed to remain in thermodynamic equilibrium, which simply means that any flashing that occurs will take place when the pressure drops below the vapor pressure of the mixture. What is called the “reduced” Omega method in API Standard 520 part I is a simplified technique in that one can take the process conditions at the pressure relief valve inlet and compare them to the process conditions at a lower pressure. This two process point comparison will represent the behavior of the mixture as the pressure drops during the opening of a pressure relief valve. The process conditions, such as the density or specific volume, at the inlet of the valve are known parameters from those on the PRV datasheet at set pressure. The second process data point required is the density or specific volume of the mixture at 90% of the flowing pressure or, in the case of 100% liquid that flashes it would be the saturation pressure at the relieving temperature. Note that the flowing pressure is taken as an absolute value. This data point is normally obtained from the fluid property database or from a process simulation flash calculation. API 520 Part I will illustrate the use of the reduced Omega Method for two conditions. One condition is a two-phase mixture at the inlet of the PRV that may or may not flash during relief and the other condition is where a 100% liquid fluid at the inlet of the PRV flashes during relief.

**API Standard 520 Part I (9th Edition) – Two-Phase Flow Mixture Procedure**

**Step One**

Calculate the Omega parameter.

$$\omega = 9 \left( \frac{v_9}{v_1} - 1 \right)$$

Where:

- v<sub>9</sub> = specific volume of the two-phase fluid at 90% of the absolute flowing pressure, ft<sup>3</sup>/lb
- v<sub>1</sub> = specific volume of the two-phase fluid at the absolute flowing at the prv inlet, ft<sup>3</sup>/lb

**Step Two**

Determine the critical pressure ratio from Figure 5-3 using w from step one. As you will note in the figure, the value of the Omega parameter will indicate whether the mixture will or will not flash.

**Step Three**

Calculate the critical pressure.

Where: 
$$P_c = \eta_c P_1$$

- P<sub>c</sub> = Critical pressure, psia
- η<sub>c</sub> = Critical pressure ratio from step two
- P<sub>1</sub> = Set pressure + allowable overpressure + atmospheric pressure – inlet piping losses, psia

**Step Four**

Determine if flow is critical or subcritical by comparing critical pressure from step three to the expected total back pressure (P<sub>2</sub>) in psia. If P<sub>c</sub> > P<sub>2</sub> then flow is critical, go to step five. If P<sub>c</sub> < P<sub>2</sub> then flow is subcritical, go to step six.

**Step Five**

Calculate the required mass flux for the service fluid if in critical flow.

$$G = 68.09 \eta_c \sqrt{\frac{P_1}{v_1 \omega}}$$

Where:

- G = Mass flux required, lb/s-ft<sup>2</sup>
- η<sub>c</sub> = Critical pressure ratio from step three
- P<sub>1</sub> = Flowing pressure, i.e. set pressure + allowable overpressure + atmospheric pressure – inlet piping losses, psia
- v<sub>1</sub> = Specific volume of the two-phase service fluid at the flowing pressure, ft<sup>3</sup>/lb
- ω = Omega parameter from step one

**Go to Step Seven**

**Step Six**

Calculate the required mass flux for the service fluid if in subcritical flow.

$$G = \frac{68.09 \sqrt{-2[\omega 1 \eta_2 + (\omega - 1)(1 - \eta_2)]} \sqrt{P_1 / v_1}}{\omega \left( \frac{1}{\eta_2} - 1 \right) + 1}$$

Where:

- G = Required Mass flux, lb/s-ft<sup>2</sup>
- P<sub>2</sub> = Total expected back pressure, psia
- P<sub>1</sub> = Flowing pressure, i.e. set pressure + allowable overpressure + atmospheric – inlet piping losses, psia
- η<sub>2</sub> = Back pressure ratio, P<sub>2</sub>/P<sub>1</sub>
- ω = Omega parameter from step one
- v<sub>1</sub> = Specific volume of the two-phase service fluid at the inlet of the valve at the flowing pressure, ft<sup>3</sup>/lb

**Step Seven**

In order to help with the two-phase nozzle discharge coefficients and back pressure correction factors for the desired Anderson Greenwood Crosby brand product, we must first determine the mass fraction ( $x_1$ ) of the gas/ vapor portion of the two-phase mixture. From the mass fraction we can determine what is called the void fraction ( $\alpha_1$ ), or volume ratio of the gas/vapor to the total volume of the two-phase mixture. This void fraction will be used to calculate the two-phase nozzle coefficient and back pressure correction factors.

$$x_1 = \frac{W_G}{W_L + W_G}$$

Where:

- $x_1$  = Mass fraction of gas/vapor portion of two-phase mixture
- $W_G$  = Required gas/vapor mass flow, lb/hr
- $W_L$  = Required liquid mass flow, lb/hr

$$\alpha_1 = \frac{x_1 v_{v1}}{v_1}$$

Where:

- $\alpha_1$  = Void fraction of two-phase mixture
- $x_1$  = Mass fraction from above calculation
- $v_{v1}$  = Specific volume of gas/vapor at the inlet of the pressure relief valve at the flowing pressure, ft<sup>3</sup>/lb
- $v_1$  = specific volume of the two-phase fluid at the inlet of the valve at the flowing pressure, ft<sup>3</sup>/lb

**Step Eight**

Select the pressure relief valve type based upon the conditions of the application. Emerson recommends the use of a safety relief valve for two-phase applications. As we learned in Chapter 3, the trim of a safety relief valve provides stable operation on either gas and/or liquid flow. Anderson Greenwood Crosby safety relief valves have certified nozzle coefficients for gas and liquid media that are used to calculate a two-phase coefficient of discharge in the next step of this procedure. It is also advisable that the safety relief valve selected to be of a balanced design for these applications. It is oftentimes difficult to accurately predict the actual magnitude of built-up back pressure that will be developed by the flow of a flashing mixture of gas and liquid. You recall that a balanced direct spring valve or pilot operated valve will maintain lift and stability at higher built-up back pressures when compared to conventional pressure relief valves. See Table 5-10 for a summary of the recommended valve designs for use in two-phase flow applications.

**Step Nine**

Determine the coefficient of discharge for the selected valve.

$$K_{2\phi} = \alpha_1 K_G + (1 - \alpha_1) K_L$$

Where:

- $K_{2\phi}$  = Two-phase coefficient of discharge
- $\alpha_1$  = Void fraction of two phase mixture from step seven
- $K_G$  = Gas/vapor coefficient of discharge. See Chapter 7 Section IX
- $K_L$  = Liquid coefficient of discharge. See Chapter 7 Section IX

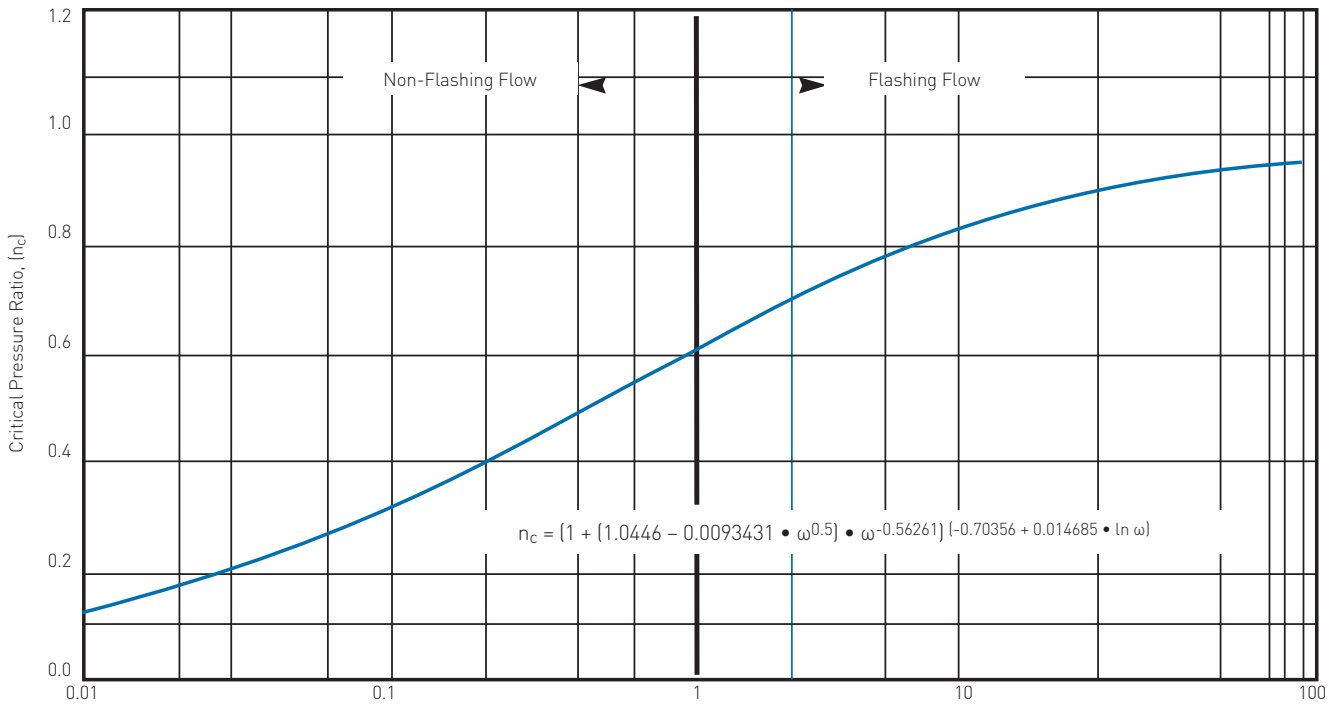


FIGURE 5-3  
 Omega Parameter,  $\omega$   
 Critical Pressure Ratio for Two-Phase Flow

**Step Ten**

If built-up or superimposed back pressure is evident, calculate the back pressure correction factor.

$$K_{bw} = \alpha_1 K_b + (1 - \alpha_1) K_w$$

Where:

- $K_{bw}$  = Two-phase back pressure correction factor
- $\alpha_1$  = Void fraction of two-phase mixture from step seven
- $K_b$  = Back pressure correction factor for gas. See Chapter 7 Section II
- $K_w$  = Capacity correction factor for balanced relief valves due to back pressure. Use  $K_w$  equal to 1.0 pilot operated or conventional safety relief valves. See Figure 7-11 for direct acting balanced safety relief valves.

**Step Eleven**

Calculate the minimum required discharge area.

$$A = \frac{0.04W}{K_{2\phi} K_{bw} K_c K_v G}$$

Where:

- $A$  = Minimum required discharge area, square inches
- $W$  = Required mass flow rate of the mixture, lb/hr
- $K_{2\phi}$  = Two-phase coefficient of discharge from step nine
- $K_{bw}$  = Two-phase back pressure correction factor from step ten
- $K_c$  = Combination factor for installations with a rupture disc upstream of the valve. See Chapter 7 Section XI for flow certified factors. Use a 0.9 value for any rupture disc/pressure relief valve combination not listed in Chapter 7. Use a 1.0 value when a rupture disc is not installed
- $K_v$  = Capacity correction factor due to viscosity of the fluid at flowing conditions. For most applications viscosity will not affect the area calculation so  $K_v$  will be equal to 1.0. See Chapter 7 Section IV for more information
- $G$  = Required Mass flux from step five or six, lb/s-ft<sup>2</sup>

**API Standard 520 Part I (9th Edition) – Subcooled or Saturated all Liquid Flashes**

Where a 100% process liquid flashes when the relief valve opens, the reduced Omega Method presented in API Standard 520 part I can also be used to predict the behavior of the new mixture of the liquid and its vapor created by the pressure drop across the valve nozzle. A liquid is called “subcooled” when it is at a temperature that is lower than its saturation temperature for a particular pressure. To use this procedure, no condensable vapor or non-condensable gas should be present in the liquid at the relief valve inlet. If these vapors or gases are in the mixture use the two-phase flow procedure discussed previously. If the service fluid is saturated water, use the ASME Section VIII Appendix 11 method below.

**Step One**

Calculate the Omega parameter.

$$\omega_s = 9 \left( \frac{\rho_{11}}{\rho_9} - 1 \right)$$

Where:

- $\omega_s$  = Saturated Omega parameter
- $\rho_9$  = Density of the mixture at 90% of the saturation or vapor pressure ( $P_s$ ) at the relieving temperature at the relief valve inlet. For multi-component liquids this represents the bubble point at the relieving temperature at the relief valve inlet, lb/ft<sup>3</sup>
- $\rho_{11}$  = Density of the liquid at the flowing pressure at the relief valve inlet, lb/ft<sup>3</sup>

**Step Two**

The Omega parameter is now used to predict if the subcooled liquid will flash upstream of the bore diameter (minimum diameter) of the nozzle or at the nozzle bore diameter. This behavior is determined by the value of what is called the transition saturation pressure ratio which is calculated as follows.

$$\eta_{st} = \frac{2\omega_s}{1 + 2\omega_s}$$

Where:

- $\eta_{st}$  = Transition saturation pressure ratio
- $\omega_s$  = Saturated Omega parameter from step one

**Step Three**

Determine where the flash of the subcooled liquid occurs as follows:  
 If  $P_s \geq \eta_{st}P_1$  then the flash occurs upstream of the nozzle bore diameter of the prv (also called the low subcooling region).  
 If  $P_s < \eta_{st}P_1$  then the flash occurs at the nozzle bore diameter of the prv (also called the high subcooling region).

Where:

- $P_s$  = Saturation or vapor pressure at the relieving temperature at the relief valve inlet, psia
- $P_1$  = Flowing pressure, i.e. set pressure + allowable overpressure + atmospheric – inlet pressure piping losses, psia
- $\eta_{st}$  = Transition saturation pressure ratio from step two

**Step Four**

Determine the ratio of the saturation pressure to the set pressure.

$$\eta_s = \frac{P_s}{P_1}$$

Where:

- $P_s$  = Saturation or vapor pressure at the relieving temperature at the relief valve inlet, psia
- $P_1$  = Flowing pressure, i.e. set pressure + allowable overpressure + atmospheric – inlet piping losses, psia

*From the calculation in step three, if the flash occurs upstream of the nozzle bore diameter (low subcooling region) then move to step five.*

*From the calculation in step three, if the flash occurs at the nozzle bore diameter (high subcooling region) skip to step ten.*

**Step Five (low subcooled liquid region)**

Determine the critical pressure ratio ( $n_c$ ) of the service fluid from Figure 5-4. Use the saturation pressure ratio ( $\eta_s$ ) from step four above and the saturated Omega ( $\omega_s$ ) value from step one above.

**TABLE 5-10 – ANDERSON GREENWOOD CROSBY RECOMMENDED VALVE DESIGNS FOR TWO-PHASE FLOW**

Conventional Direct Spring PRV <sup>1</sup>	Balanced Direct Spring PRV	Pilot Operated PRV
JLT-JOS-E Series 900	JLT-JBS-E	Series 400/500/800

Note 1 – The magnitude of the built-up back pressure can be difficult to predict for two-phase flow. It is advisable to use either a balanced direct spring or pilot operated PRV if this value is uncertain.

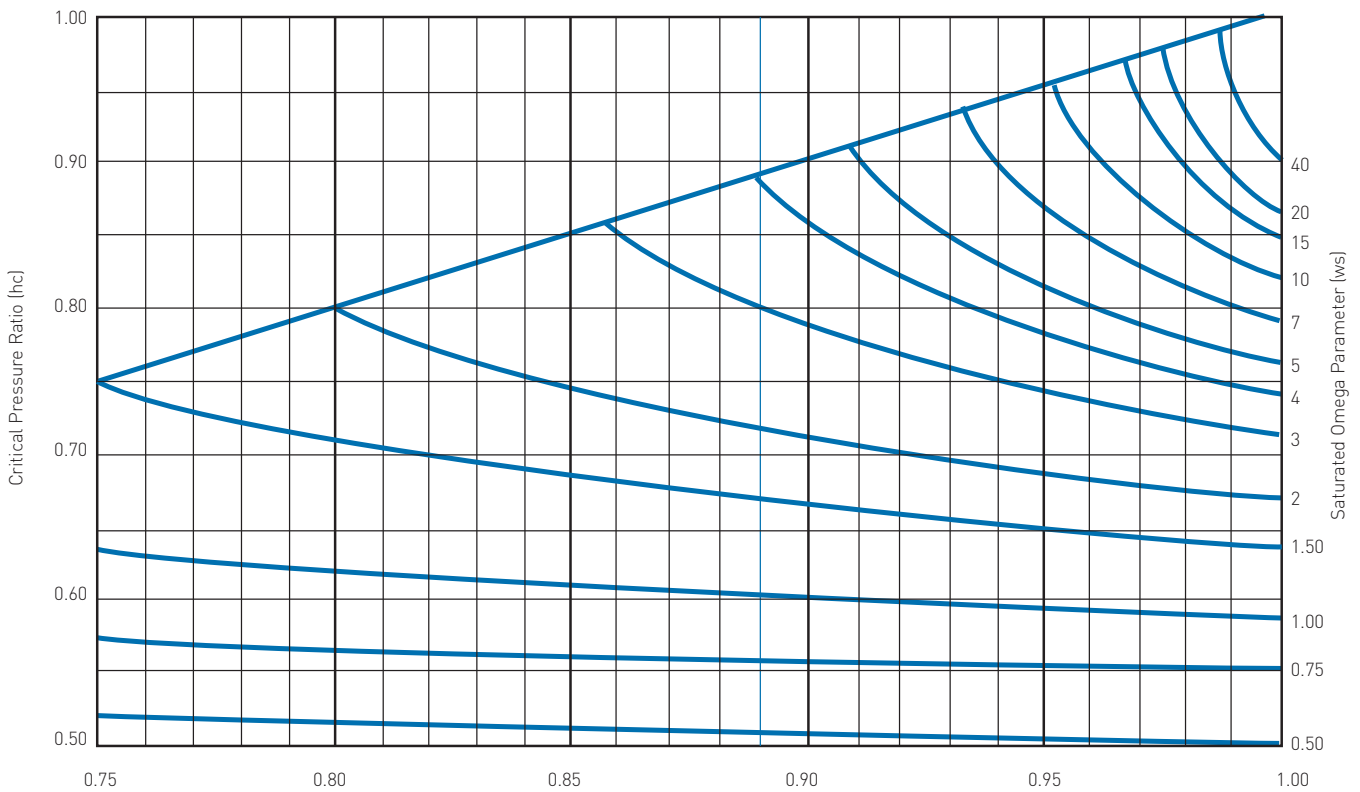


FIGURE 5-4  
 Saturated Pressure Ratio ( $h_s$ )  
 Critical Pressure Ratio for Low Subcooled Region Flashing Liquids

**Step Six (low subcooled liquid region)**

Calculate the critical pressure ( $P_c$ ) using the critical pressure ratio and determine whether the flow is critical or subcritical.

$$P_c = \eta_c P_1$$

Where:

- $P_c$  = Critical pressure, psia
- $\eta_c$  = Critical pressure ratio from step five
- $P_1$  = Set pressure + allowable overpressure + atmospheric - inlet piping losses, psia

**If  $P_c \geq P_2$  then flow is critical (go to step seven).**

**If  $P_c < P_2$  then flow is subcritical (skip step seven and go to step eight).**

Where:

- $P_2$  = The total expected built-up and superimposed back pressure, psia

**Step Seven (low subcooled liquid region in critical flow)**

Calculate the required mass flux.

$$G = \frac{68.09 \sqrt{2(1-\eta_s) + 2[\omega_s \eta_s \ln(\frac{\eta_s}{\eta_c}) - (\omega_s - 1)(\eta_s - \eta_c)]} \sqrt{P_1 \rho_{l1}}}{\omega_s \left( \frac{\eta_s}{\eta_c} - 1 \right) + 1}$$

Where:

- $G$  = Required mass flux, lb/s-ft<sup>2</sup>
- $\eta_s$  = Saturated pressure ratio from step four
- $\omega_s$  = Saturated Omega parameter from step one
- $\eta_c$  = Critical pressure ratio from step five
- $P_1$  = Flowing pressure, i.e. set pressure + allowable overpressure + atmospheric - inlet piping losses, psia
- $\rho_{l1}$  = Density of the liquid at the set pressure at the relief valve inlet, lb/ft<sup>3</sup>

**Skip steps eight and nine and go to step thirteen.**



**Step Eight (low subcooled liquid region in subcritical flow)**

Calculate the subcritical pressure ratio.

$$\eta_2 = \frac{P_2}{P_1}$$

Where:

- P<sub>2</sub> = The total expected built-up and superimposed back pressure, psia
- P<sub>1</sub> = Flowing pressure, i.e. set pressure + allowable overpressure + atmospheric – inlet piping losses, psia

**Step Nine (low subcooled liquid region in subcritical flow)**

Calculate the mass flux.

$$G = \frac{68.09 \sqrt{2(1-\eta_s) + 2[\omega_s \eta_s \ln(\frac{\eta_s}{\eta_2}) - (\omega_s - 1)(\eta_s - \eta_2)]} \sqrt{P_1 \rho_{11}}}{\omega_s \left( \frac{\eta_s}{\eta_2} - 1 \right) + 1}$$

Where:

- G = Required mass flux, lb/s-ft<sup>2</sup>
- n<sub>s</sub> = Saturated pressure ratio from step four
- ω<sub>s</sub> = Saturated Omega parameter from step one
- η<sub>2</sub> = Subcritical pressure ratio from step eight
- P<sub>1</sub> = Set pressure + allowable overpressure + atmospheric – inlet piping losses, psia
- ρ<sub>11</sub> = Density of the liquid at the set pressure at the relief valve inlet, lbs/ft<sup>3</sup>

**Skip to step thirteen.**

**Step Ten (high subcooled liquid region)**

Determine if flow is critical or subcritical.

**If P<sub>s</sub> ≥ P<sub>2</sub> then flow is critical (go to step eleven).**

**If P<sub>s</sub> < P<sub>2</sub> then flow is subcritical (skip step eleven and go to step twelve).**

Where:

- P<sub>s</sub> = Saturation or vapor pressure at the relieving temperature at the relief valve inlet, psia
- P<sub>2</sub> = The total expected built-up and superimposed back pressure, psia

**Step Eleven (high subcooled liquid region in critical flow)**

Calculate the mass flux.

$$G = 96.3 \sqrt{[\rho_{11} (P_1 - P_s)]}$$

Where:

- G = Required mass flux, lb/s-ft<sup>2</sup>
- ρ<sub>11</sub> = Density of the liquid at the set pressure at the relief valve inlet, lb/ft<sup>3</sup>
- P<sub>1</sub> = Flowing pressure, i.e. set pressure + allowable overpressure + atmospheric – inlet piping losses, psia
- P<sub>s</sub> = Saturation or vapor pressure at the relieving temperature at the relief valve inlet, psia

**Skip to step thirteen.**

**Step Twelve (high subcooled liquid region in subcritical flow)**

Calculate the mass flux.

$$G = 96.3 \sqrt{[\rho_{11} (P_1 - P_2)]}$$

Where:

- G = Required mass flux, lb/s-ft<sup>2</sup>
- ρ<sub>11</sub> = Density of the liquid at the flowing pressure at the relief valve inlet, lb/ft<sup>3</sup>
- P<sub>1</sub> = Flowing pressure, i.e. set pressure + allowable overpressure + atmospheric – inlet piping losses, psia
- P<sub>2</sub> = The total expected built-up and superimposed back pressure, psia

**Step Thirteen**

Select the proper pressure relief valve type based upon the conditions of the application. Since the liquid is flashing to give a certain amount of two-phase flow through the pressure relief valve, Emerson recommends that a safety relief valve (operates in a stable fashion on either compressible or incompressible media) be selected. Since there will be flashing, Emerson recommends a balanced type pressure relief valve due to pressure variations that can occur in the valve body outlet. See Table 5-10 for a summary of recommended valve designs for use in two-phase flow applications.

**Step Fourteen**

Calculate the minimum required discharge area.

$$A = \frac{0.3208 V_L \rho_{11}}{K K_v K_w G}$$

Where:

- A = Minimum required discharge area, square inches
- V<sub>L</sub> = Required relieving capacity, U.S. gallons per minute at flowing temperature
- ρ<sub>11</sub> = Density of the liquid at the flowing pressure at the relief valve inlet, lb/ft<sup>3</sup>
- K = Coefficient of discharge for liquid service. See Chapter 7 Section IX
- K<sub>v</sub> = Capacity correction factor due to viscosity of the fluid at flowing conditions. For most applications viscosity will not affect the area calculation so K<sub>v</sub> will be equal to 1.0. See Chapter 7 Section IV
- K<sub>w</sub> = Capacity correction factor for balanced relief valves due to back pressure. Use K<sub>w</sub> equal to 1.0 for pilot operated and conventional safety relief valves. See Figure 7-11 for direct acting balanced safety relief valves
- G = Required mass flux from either steps 7, 9, 11, or 12, lb/s-ft<sup>2</sup>

**ASME Section VIII, Appendix 11 – Flashing of Saturated Water**

When the process fluid at the pressure relief valve inlet is entirely saturated water one can refer to ASME Section VIII Appendix 11 to estimate the available mass flux for specific valve designs. Figure 5-5 is taken from Appendix 11 of the Code. The specific valve design requirements in order to use Figure 5-5 are:

- The ratio of the nozzle bore diameter (smallest cross section) to prv inlet diameter must fall between 0.25 and 0.80.
- The actual (not rated) nozzle coefficient for gas/vapor service must exceed 0.90.

**Step One**

Determine the available mass flux for a pressure relief valve that meets the above design requirements at the required set pressure from Figure 5-5. The curve in Figure 5-5 is based upon 10% overpressure. Use this available mass flux if sizing allows for higher overpressures as this will be a conservative value.

An example would be that a saturated water installation is requiring a prv to be set at 400 psig with a required capacity of 100,000 lb/hr. Please note that the ordinate axis has the available mass flux denoted in 10<sup>-4</sup> units so the available mass flux at 400 psig would be 6 x 10,000 or 60,000 lb/hr/in<sup>2</sup>.

**Step Two**

Divide the required saturated water capacity by the available mass flux determined in step one to obtain the minimum required discharge area of the valve.

$$A = \frac{W}{G}$$

Where:

W = Required relieving capacity of saturated water, lb/hr

G = Available prv mass flux from step one

So following with the example above, if the required saturated water capacity is 100,000 lb/hr, the required discharge or orifice area of the valve would be 100,000 (lb/hr) ÷ 60,000 (lb/hr/in<sup>2</sup>) = 1.667 in<sup>2</sup>.

**Step Three**

Select the proper pressure relief valve type based upon the conditions of the application and meet the design requirements required by the ASME Code that are listed above. Emerson recommends the use of a balanced type pressure relief valve due to pressure variations that can occur in the valve body outlet.

The following Crosby and Anderson Greenwood balanced valves meet the design requirements and may be considered:

- Balanced Direct Spring (JLT-JBS-E)
- Modulating POPRV (Series 400/500/800) in 1F2, 1.5H3, 2J3, 3L4, 4P6, 6R8, 8T10 or any full bore (FB) orifice configuration

Go to Chapter 7 and review the ASME (do not use the API tables) actual orifices for gas service listed in Tables 7-7 and 7-12 that are available for the valve types listed above.

Therefore, to complete the example where we have a minimum orifice area requirement of 1.667 in<sup>2</sup> we can look at Table 7-7 for a JLT-JBS-E configuration. This table will show a 3" inlet valve, with a "K" orifice designation, will have 2.076 in<sup>2</sup> available. Provided the other requirements of the application meet this valve's specifications, this configuration would be an appropriate choice.

**VIII. NOISE LEVEL CALCULATIONS**

The following formulas are used for calculating noise level of gases, vapors and steam as a result of the discharge of a pressure relief valve to atmosphere.

$$L_{100} = L + \left[ 10 \log_{10} \left( 0.29354 \frac{WkT}{M} \right) \right]$$

Where:

- $L_{100}$  = Sound level at 100 feet from the point of discharge in decibels
- $L$  = Sound level from Figure 5-6 in decibels
- $P_1$  = Pressure at the valve inlet during flow, psia. This is the set pressure (psig) + overpressure (psig) + atmospheric pressure (psia) – inlet pressure piping losses (psig)
- $P_2$  = Pressure at the valve outlet during flow, psia [bara]. This is total back pressure (psig) + atmospheric pressure (psia)
- $k$  = Specific heat ratio. See Chapter 7 Section VII
- $M$  = Molecular weight of the gas or vapor. See Chapter 7 Section VII
- $T$  = Absolute temperature of the fluid at the valve inlet, degrees Rankine ( $^{\circ}\text{F} + 460$ )
- $W$  = Maximum relieving capacity, lb/hr

The noise level should be calculated using the maximum or total flow through the pressure relief valve at the specified overpressure. This value can be calculated by using the sizing formulas on page 5.4 for weight flow and solving for "W". Use the "actual" area and "actual" coefficient of discharge for the specific valve from tables in Chapter 7. The actual coefficient is the "rated coefficient" divided by 0.90. When the noise level is required at a distance of other than 100 feet, the following equation shall be used:

$$L_p = L_{100} - 20 \log_{10} \left( \frac{r}{100} \right)$$

Where:

- $L_p$  = Sound level at a distance, r, from the point of discharge in decibels
- $r$  = Distance from the point of discharge, feet

Table 5-11 lists some relative noise intensity levels

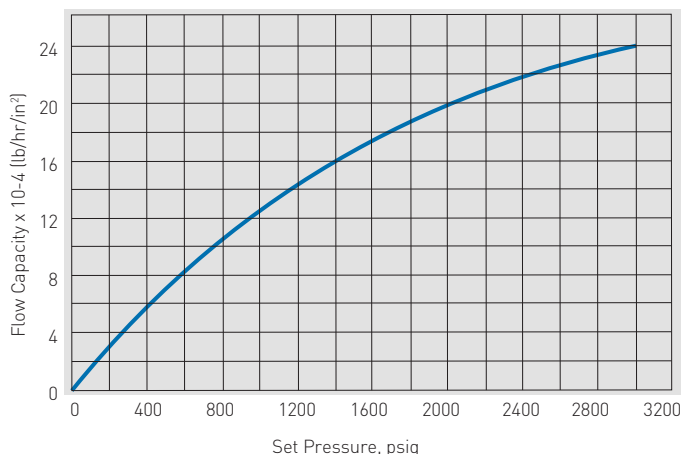


FIGURE 5-5  
 ASME Section VIII Appendix 11  
 Available Mass Flux - Saturated Water

**TABLE 5-11 – NOISE INTENSITY (at 100 feet from the discharge)**

Relative Noise Levels		
130	Decibels	Jet Aircraft on Takeoff
120	Decibels	Threshold of Feeling
110	Decibels	Elevated Train
100	Decibels	Loud Highway
90	Decibels	Loud Truck
80	Decibels	Plant Site
70	Decibels	Vacuum cleaner
60	Decibels	Conversation
50	Decibels	Offices

**IX. REACTION FORCES**

The discharge from a pressure relief valve exerts a reaction force on the valve, vessel and/or piping as a result of the flowing fluid. Determination of outlet reaction forces and the design of an appropriate support system is the responsibility of the designer of the vessel and/or piping. The following is published as technical advice or assistance.

**Reaction Force for Open Discharge – Gas Service**

The following formulas are used for the calculation of reaction forces for a pressure relief valve discharging gas or vapor directly to atmosphere. It is assumed that critical flow of the gas or vapor is obtained at the discharge outlet. Under conditions of subcritical flow the reaction forces will be less than that calculated. These equations are found in API Recommended Practice 520 Part II.

$$F = \frac{W}{366} \sqrt{\frac{kT_i}{(k+1)M} + A_o [P_2 - P_A]}$$

Where:

- F = Reaction force at the point of discharge to atmosphere, lb<sub>f</sub>. See Figure 5-7
- A<sub>o</sub> = Area at discharge, square inches
- k = Specific heat ratio at the outlet conditions
- M = Molecular weight of the gas or vapor obtained from standard tables. See Chapter 7 Section XI
- P<sub>2</sub> = Static pressure at discharge, psia calculated below:

$$P_2 = 0.001924 \frac{W}{A_o} \sqrt{\frac{T_o}{kM}}$$

- P<sub>A</sub> = Ambient pressure, psia
- T<sub>i</sub> = Absolute temperature of the fluid at the valve inlet, degrees Rankin (°F + 460)
- T<sub>o</sub> = Absolute temperature of the fluid at the discharge, degrees Rankin (°F + 460)
- W = Actual relieving capacity, lb/hr. This value may be calculated by using the sizing formula on page 5.4 for weight flow. Use the ASME actual area and the rated coefficient divided by 0.9 to get the actual capacity of the valve.

The above equations account for static thrust force only and do not consider a force multiplier required for rapid application of the reactive thrust force. ASME B31.1

Non-Mandatory Appendix II includes a method of analysis for dynamic load factors. Force multipliers up to two times F are possible. This is only necessary for open discharge with rapid opening valves. A minimum value of 1.1 x F is recommended for other installation types.

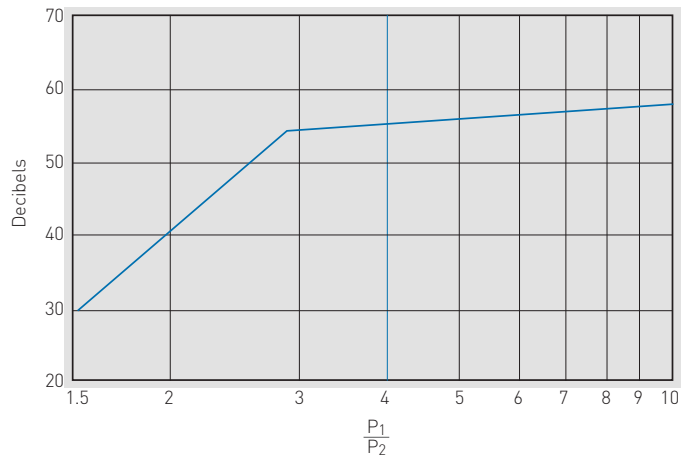


FIGURE 5-6  
 Sound Pressure Level at 100 Feet from Point of Discharge

**Reaction Force for Open Discharge – Steam Service**

The following formula is used for the calculation of reaction forces for a pressure relief valve discharging steam directly to atmosphere. The equations are based on equations in ASME B31.1 Non-mandatory Appendix II.

$$F = 6.98 \times 10^{-4} W (\sqrt{h_o - 823}) + A_o [P_2 - P_A]$$

Where:

- F = Reaction force at the point of discharge to atmosphere, lb<sub>f</sub>. See Figure 5-7
- h<sub>o</sub> = Stagnation enthalpy at the valve inlet, Btu/lbm
- A<sub>o</sub> = Area at discharge, square inches
- P<sub>2</sub> = Static pressure at discharge, psia
- P<sub>A</sub> = Ambient pressure, psia
- W = Actual relieving capacity, lb/hr. This value may be calculated by using the sizing formula on page 5.5 for weight flow. Use the ASME actual area and the rated coefficient divided by 0.9 to get the actual capacity of the valve

The above equations account for static thrust force only and do not consider a force multiplier required for rapid application of the reactive thrust force. ASME B31.1

Non-Mandatory Appendix II includes a method of analysis for dynamic load factors. Force multipliers up to two times F are possible. This is only necessary for open discharge with rapid opening valves (i.e. ASME Section I safety valves).

**Reaction Force for Open Discharge – Liquid Service**

The following formula is used for the calculation of reaction forces for a pressure relief valve discharging liquid directly to atmosphere. The equations are based on fluid momentum. Liquid flow is assumed to be non-flashing.

$$F = \frac{(3.44 \times 10^{-7}) W^2}{\rho A_o}$$

Where:

- F = Reaction force at the point of discharge to atmosphere, lb<sub>f</sub>. See Figure 5-7
- A<sub>o</sub> = Area at discharge, square inches
- W = Actual relieving capacity, lb/hr. This value may be calculated by using the sizing formula on page 5.11 for volumetric flow and then converting to weight flow. Use the ASME actual area and the rated coefficient divided by 0.9 to get the actual volumetric capacity of the valve. To obtain the actual capacity, W, in lb/hr use the conversions in Table 7-20
- ρ = Density of the fluid, lb<sub>m</sub>/ft<sup>3</sup>

**Reaction Force for Open Discharge – Two-Phase Flow**

The following formula is found in API Recommended Practice 520 Part II. This formula assumes the two-phase flow is in a homogeneous condition (well mixed and both phases flowing at the same velocity).

$$F = \frac{W^2}{(2.898 \times 10^6) A_o} \left[ \frac{X}{\rho_g} + \frac{1-X}{\rho_l} \right] + A (P_E - P_A)$$

- F = reaction force at point of discharge to atmosphere, lb<sub>f</sub>. See Figure 5-7.
- W = Actual relieving capacity, lb/hr
- A<sub>o</sub> = Area at discharge outlet to atmosphere, square inches
- X = Mass fraction of gas/vapor portion  $\left( \frac{W_G}{W} \right)$
- W<sub>G</sub> = Actual relieving capacity of gas, lb/hr
- ρ<sub>g</sub> = Vapor density at exit conditions, lbm/ft<sup>3</sup>
- ρ<sub>l</sub> = Liquid density at exit conditions, lbm/ft<sup>3</sup>
- P<sub>E</sub> = Pressure at pipe exit, psia
- P<sub>A</sub> = Ambient pressure, psia

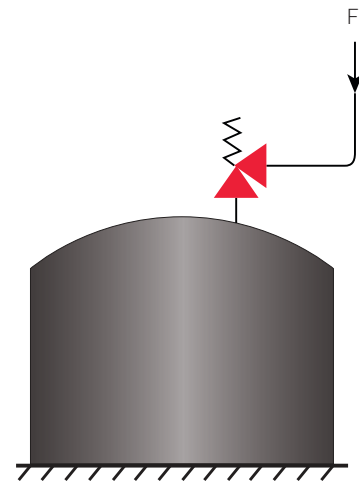


FIGURE 5-7 – OPEN DISCHARGE REACTION FORCE

# PRESSURE RELIEF VALVE ENGINEERING HANDBOOK

## CHAPTER 6 – VALVE SIZING AND SELECTION – METRIC UNITS

---

### THE FOLLOWING DATA WITH CHARTS AND TABLES ARE INCLUDED IN THIS CHAPTER:

---

<b>I. Introduction</b> .....	6.3
Procedure.....	6.3
Pressure Relief Valve Nozzle Coefficient of Discharge.....	6.3
API vs ASME Nozzle Coefficient of Discharge .....	6.3
<b>II. Gas/Vapor Sizing – Sonic Flow</b> .....	6.4
Equations, Variables, Unit of Measures	
<b>III. Gas/Vapor Sizing – Subsonic Flow</b> .....	6.5
Equations, Variables, Unit of Measures	
<b>IV. Steam Sizing</b> .....	6.6
Equations, Variables, Unit of Measures	
ASME Section VIII.....	6.6
ASME Section I.....	6.6
<b>V. Liquid Sizing</b> .....	6.11
Equations, Variables, Unit of Measures	
Thermal Relief	
<b>VI. Fire Sizing</b> .....	6.13
Liquid Filled Vessels.....	6.13
API 521 (ISO 23251).....	6.13
API 2000 (ISO 28300).....	6.14
Gas Filled Vessels.....	6.15
<b>VII. Two-Phase Sizing</b> .....	6.15
API 520 Part I (8th Edition) .....	6.16
Two-Phase Flow Mixture Procedure.....	6.17
Subcooled or Saturated All Liquid Flashes.....	6.19
ASME Section VIII.....	6.22
Flashes at Saturated Water .....	6.22
<b>VIII. Noise Level Calculations</b> .....	6.23
<b>IX. Reaction Forces</b> .....	6.24
Gas Service.....	6.24
Steam Service .....	6.25
Liquid Service.....	6.25
Two-Phase Service .....	6.25

# PRESSURE RELIEF VALVE ENGINEERING HANDBOOK

## CHAPTER 6 – VALVE SIZING AND SELECTION – METRIC UNITS

---

### THE FOLLOWING FIGURES ARE INCLUDED IN THIS CHAPTER:

---

Figure 6-1 Closed Simple Rankine Steam Cycle .....	6.7
Figure 6-2 Critical Pressure Ratio for Two-Phase Flow .....	6.16
Figure 6-3 Critical Pressure Ratio for Low Subcooled Region Flashing Liquids .....	6.19
Figure 6-4 ASME Section VIII Appendix 11 Available Mass Flux - Saturated Water.....	6.23
Figure 6-5 Sound Pressure Level at 30 Meters from Point of Discharge.....	6.23
Figure 6-6 Open Discharge Reaction Force.....	6.25

### THE FOLLOWING TABLES ARE INCLUDED IN THIS CHAPTER:

---

Table 6-1 – 4020 A Weight Loaded Pressure Flow Capacity (Pipeaway Version).....	6.5
Table 6-2 – ASME Section I Drum/Superheater Sizing Example Summary.....	6.8
Table 6-3 – Saturated Steam Capacities - Set Pressures 173-213 barg.....	6.10
Table 6-4 – ASME Section I Reheater Sizing Example Summary .....	6.11
Table 6-5 – Saturated Steam Capacities - Set Pressures 44-86 barg.....	6.12
Table 6-6 – Environmental Factor .....	6.14
Table 6-7 – ISO 28300 Heat Input Equations.....	6.14
Table 6-8 – Anderson Greenwood Crosby Selection for Two-Phase Flow .....	6.17
Table 6-9 – Noise Intensity (at 30 Meters from the Discharge).....	6.24

### I. INTRODUCTION

---

This section of the Emerson Pressure Relief Valve Engineering Handbook is laid out to assist the user in the sizing and selection of pressure relief valves when system parameters are expressed in metric units. The procedures and equations in this chapter are consistent with the requirements of the ASME Boiler and Pressure Vessel Code, API and ISO recommended practices and standards. Please refer to Chapter 5 for sizing using United States Customary System (USCS). Please visit the Emerson Sizing Website for access to PRV2SIZE. The address is [valvesizing.emerson.com](http://valvesizing.emerson.com). This sizing program will perform many of the sizing techniques discussed in this chapter.

#### Procedure

Before the determination can be made of the required pressure relief valve orifice area, an in-depth analysis of various overpressure scenarios for the equipment being protected must be completed. ISO 23251 or API Standard 521 is oftentimes used as a guide to determine what possible causes of overpressure could occur and what subsequent required relieving capacity is necessary to mitigate the system upset. These standards will help the process engineer determine the worst case scenario from unexpected system conditions such as blocked outlets, reflux failures, power failures, overfilling, exchanger tube damage, and external fire. There are many other possible overpressure conditions listed in the standard.

ISO 28300 or API Standard 2000 contains similar information on causes of overpressure and vacuum, and the required relieving capacity for the protection of atmospheric or low pressure storage tanks.

One key piece of information for the sizing of the pressure relief valve is the knowledge of the largest required capacity that results from one of these overpressure conditions. This required capacity is often referred to as the "worst case scenario." This chapter will help you with the sizing techniques to obtain the proper pressure relief valve orifice for this worst case scenario.

It should be noted however, that the final selection of the pressure relief valve type and its materials of construction may be based upon other overpressure contingencies. For example, a worst case scenario may be when a liquid is boiled off into a vapor due to an external fire. A pressure relief valve is sized based upon this vapor flow rate. There may be another overpressure condition where the liquid could overflow and this liquid flow rate requires a smaller orifice. As we learned in Chapter 4, not all pressure relief valve trims designed for vapor flow work well on liquid flow. If the lesser contingency is ignored during the pressure relief device selection then an improper valve might be installed.

#### Pressure Relief Valve Nozzle Coefficient of Discharge

As you review the various orifice sizing formulas in this chapter, you will note that there will almost always be one variable that will be listed as the valve coefficient of discharge. This value is specific to a particular valve design and illustrates the imperfect flow characteristics of the device. The best nozzle coefficient of discharge ( $K_d$ ) would be that of an ideal nozzle. The value of the  $K_d$  is the quotient of the actual measured flow divided by the theoretical flow of an ideal nozzle. Therefore, the  $K_d$  for a particular valve can be no larger than 1.0.

There are various codes and standards that require actual flow tests to be performed to establish the flow efficiency of a pressure relief valve. For example, there are testing procedures described in documents, such as the ASME Boiler and Pressure Vessel Code, ISO 4126, and ISO 28300 that will establish the  $K_d$  of a particular valve design.

If you look further in either Section I or Section VIII of the ASME Code or ISO 4126, there is one procedure where the manufacturer is required to test three valves in three different sizes, for a total of nine tests.

The  $K_d$  value for each of these nine tests is calculated and averaged.

The requirement is that none of these nine  $K_d$  values can vary any more than plus or minus 5% of the average  $K_d$ .

Most gas or steam certified safety valves that use the nozzle bore as the flow limiting dimension are quite efficient as compared to the ideal nozzle. It is not unusual to have a  $K_d$  value of 0.950 or higher for these valves. The  $K_d$  value for liquid certified relief valves is much lower or in the range of 0.750.

An additional requirement in the ASME Code (both Section I and Section VIII) and ISO 4126 is to reduce the flow tested  $K_d$  value by 10%. This reduced coefficient provides an additional safety factor when calculating the required flow area for a pressure relief valve. For example, if a safety valve is tested to have a  $K_d$  equal to 0.950 then the ASME or ISO 4126 rated nozzle coefficient of discharge is  $0.950 \times 0.900$  or 0.855. This ASME rated nozzle coefficient is typically denoted as  $K$  ( $K = K_d \times 0.9$ ) and the ISO 4126 rated nozzle coefficient is typically denoted as  $K_{dr}$  ( $K_{dr} = K_d \times 0.9$ ). For this chapter, the rated nozzle coefficient is shown as "K". The valve sizing formulas outside of the scope of ASME (below 1.03 barg) will use the actual flow tested  $K_d$  values.



**API Effective vs ASME Section VIII Rated Nozzle Coefficient of Discharge**

The ASME Section VIII (and ISO 4126) rated nozzle coefficient of discharge (K) will vary from one valve design to the other, one service (i.e. compressible versus incompressible) to the other, and one manufacturer to the other. Therefore, if the valve manufacturer and/or the valve design is not yet selected, and a preliminary pressure relief valve size for a ASME Section VIII valve is needed, many users will refer to API Standard 520 part I to obtain what are called effective nozzle coefficients. This recommended practice publishes one common nozzle coefficient of discharge for gases, steam and liquids to be used for preliminary sizing of the flow orifice area.

When selecting the preliminary flow orifice size, API 520 part I will point the user to the API Standard 526. This API 526 standard is where you will find the effective flow orifice sizes for what are more commonly called the “lettered” orifice designations. The scope of the API 526 standard is DN25 x DN50 (D orifice designation) through a DN200 x DN250 (T orifice designation). The scope of API 526 is limited to flanged direct spring loaded and flanged pilot operated pressure relief valves.

Once the manufacturer and specific design are decided, API 520 part I will instruct the user to recalculate the required flow orifice size using the ASME rated nozzle coefficient of discharge (K). The actual flow orifice area of the valve selected should be compared to meet or exceed the calculated orifice area value.

The API effective coefficient of discharge and effective orifice areas are illustrated with the applicable Anderson Greenwood Crosby models that meet API Standard 526. The direct spring valves are shown in Table 8-6 and the pilot operated valves are shown in Table 8-11. The preliminary sizing per API can be completed using these values. You will note that the information for the effective nozzle coefficients and orifice areas are exactly the same for the two different valve designs.

The ASME rated coefficient of discharge (K) and the actual flow orifice area for these same valve designs are shown in Table 8-7 for the direct spring valves and Table 8-12 for the pilot operated valves. You will now notice the rated coefficient of discharge and actual flow orifice areas are different because these values are specific to the valve design.

The user should be aware that the use of the API effective values in sizing these particular Anderson Greenwood Crosby products will always be conservative. The recalculation of the required orifice size using rated coefficient of discharge (K) and comparing the answer to the actual orifice area will always allow for the same valve size, or smaller, to that identified in the preliminary API sizing.

*In no case should an API effective coefficient of discharge or effective area be used with the rated coefficient of discharge or actual area to perform any calculation. Sizing errors can be made if the effective values are mixed with the actual values.*

For Anderson Greenwood Crosby valve designs that do not fall within the scope of API 526, such as portable valves, ASME Section I valves, or full bore pilot operated valves, it is suggested to always use the rated coefficient of discharge and actual orifice area for any sizing.

**II. GAS/VAPOR SIZING – SONIC FLOW**

The orifice sizing for vapors or gases can be done either by capacity weight or by volumetric flow rates. The formulas used are based on the perfect gas laws. These laws assume that the gas neither gains nor loses heat (adiabatic), and that the energy of expansion is converted into kinetic energy. However, few gases behave this way and the deviation from the perfect gas laws becomes greater as the gas approaches saturated conditions. Therefore, the sizing equations will contain various correction factors, such as the gas constant (C) and the compressibility factor (Z), that illustrate deviation from the perfect gas law.

**Set Pressures ≥ 1.03 barg**

The following formulas can be used for sizing valves when the set pressure is at or above 1.03 barg.

Weight Flow (kg/hr)

$$A = \frac{W}{CKP_1K_bK_c} \sqrt{\frac{TZ}{M}}$$

Volumetric Flow (Nm<sup>3</sup>/hr)

$$A = \frac{V \sqrt{MTZ}}{22.42CKP_1K_bK_c}$$

Where:

- A = Minimum required discharge area, square millimeters
- C = Gas constant based upon the ratio of specific heats of the gas or vapor at standard conditions. See Chapter 8 Section VI. Use C = 2.390 if ratio of specific heats is unknown
- K = Coefficient of discharge. See Chapter 8 Section IX
- K<sub>b</sub> = Back pressure correction factor for gas. See Chapter 8 Section II
- K<sub>c</sub> = Combination factor for installations with a rupture disc upstream of the valve. See Chapter 8 Section XI for flow certified factors. Use a 0.9 value for any rupture disc/pressure relief valve combination not listed in Chapter 8 Section XI. Use a 1.0 value when a rupture disc is not installed
- M = Molecular weight of the gas or vapor. See Chapter 8 Section VII for common gases
- P<sub>1</sub> = Relieving pressure, bars absolute. This is the set pressure (barg) + overpressure (barg) + atmospheric pressure (bara) – inlet pressure piping loss (barg)
- T = Absolute relieving temperature of the gas or vapor at the valve inlet, degree Kelvin (degree Celsius + 273)
- W = Required relieving capacity, pounds per hour (kg/hr)
- V = Required relieving capacity, normal cubic meters per hour (Nm<sup>3</sup>/hr)
- Z = Compressibility factor. See Chapter 8 Section I

**III. GAS/VAPOR SIZING – SUBSONIC FLOW**

**Set Pressures < 1.03 barg or Vacuum Conditions**

The following formulas can be used for sizing valves when the set pressure is below 1.03 barg. When pressure relief valves operate on gases or vapors below 1.03 barg the speed at which the service fluid travels is always less than the speed of sound or subsonic. Under these conditions, the flow decreases with increasing back pressure even though the upstream flowing pressure stays the same. These equations can be used to size the Anderson Greenwood pilot operated valves listed in Chapter 8 (Tables 8-14 and 8-15).

The flow characteristics for the Whessoe Varec brand weight loaded pressure and vacuum vents are unique, not only for each model, but also for each size of a particular model. The coefficient of discharge method is different for each of these many combinations and is not easy to select an orifice size with equations. It is suggested to use flow capacity charts from the Whessoe and Varec catalog to manually select the valve size. The example shown in Table 6-1 shows the available flow capacity for a vent with a set pressure of 10 mbar. One point on this chart shows that a 6 inch vent with 50% overpressure (i.e. 15 mbar flowing pressure) will flow 1289 Nm<sup>3</sup>/hr.

Weight Flow (kg/hr)

$$A = \frac{W \sqrt{TZ}}{5.6 K_d P_1 F \sqrt{M}}$$

Volumetric Flow (Nm<sup>3</sup>/hr)

$$A = \frac{V \sqrt{MTZ}}{125.15 K_d P_1 F}$$

Where:

$$F = \sqrt{\frac{k}{k-1} \left[ \left( \frac{P_2}{P_1} \right)^{\frac{2}{k}} - \left( \frac{P_2}{P_1} \right)^{\frac{k+1}{k}} \right]}$$

Where:

- A = Minimum required discharge area, square millimeters
- K<sub>d</sub> = Coefficient of discharge. See Chapter 8 (Tables 8-14 and 8-15)
- k = Specific heat ratio. See Chapter 8 Section VII for common gases
- M = Molecular weight of the gas or vapor. See Chapter 8 Section VII for common gases
- P<sub>1</sub> = Relieving pressure, bars absolute. This is the set pressure (barg) + overpressure (barg) + atmospheric pressure (bara) – inlet pressure piping loss (barg)
- P<sub>2</sub> = Pressure at the valve outlet during flow, bars absolute. This is the total back pressure (barg) + atmospheric pressure (bara)
- T = Absolute relieving temperature of the gas or vapor at the valve inlet, degree Kelvin (degree Celsius + 273)
- W = Required relieving capacity, kilograms per hour (kg/hr)
- V = Required relieving capacity, normal cubic meters per hour (Nm<sup>3</sup>/hr)
- Z = Compressibility factor. See Chapter 8 Section I

**TABLE 6-1 – 4020A WEIGHT LOADED PRESSURE FLOW CAPACITY (Pipeaway Version)**

Set Press. mbar	2"			3"			4"			6"			8"			10"			12"		
	20%	25%	50%	20%	25%	50%	20%	25%	50%	20%	25%	50%	20%	25%	50%	20%	25%	50%	20%	25%	50%
2.5	36	52	72	84	116	161	150	206	286	338	464	644	601	825	1146	939	1289	1790	1352	1856	2577
10	75	103	143	169	232	322	300	412	573	676	928	<b>1289</b>	202	1650	2291	1877	2578	3580	2704	3712	5155
25	119	163	226	267	367	509	475	652	906	1069	1467	2038	1900	2608	3622	2969	4076	5660	4275	5869	8151
50	168	231	320	378	519	720	672	922	1281	1511	2075	2882	2687	3689	5123	4198	5764	8005	6045	8300	11527
60	184	253	351	414	568	789	736	1010	1403	1656	2273	3157	2943	4041	5612	4599	6314	8769	6622	9092	12627

Flow in m<sup>3</sup>/hr

**IV. STEAM SIZING**

**ASME Section VIII (Set Pressures ≥ 15 psig)**

The following formula is used for sizing safety valves for process vessel applications that normally are not considered fired vessels. Examples of fired vessels are economizers, steam drums, superheaters and reheaters that fall under the ASME Section I scope. As discussed in the previous gas/vapor section, the determination of the required steam relieving rate is needed before sizing can begin. Once again the use of ISO 23251 (API Standard 521) can be helpful to determine the required steam flow due to sources of overpressure such as a split exchanger tube or reflux failures.

This formula is based upon the empirical Napier formula for steam flow. The nozzle coefficient of discharge and the back pressure correction factors are the same as those in the previous gas/vapor section. There is a new factor for steam that is above its saturation temperature, or is in a superheated condition. The more superheated the steam, the greater the required orifice area. A second, but rarely used input, is the Napier equation correction factor. This factor is only used for dry saturated steam when the set pressure is 103.5 bara or greater.

$$A = \frac{W}{0.525 K P_1 K_{sh} K_n K_b}$$

Where:

- A = Minimum required discharge area, square millimeters
- W = Required relieving capacity, (kg/hr)
- K = Coefficient of discharge. See Chapter 8 Section IX
- P<sub>1</sub> = Relieving pressure, bars absolute. This is the set pressure (barg) + overpressure (barg) + atmospheric pressure (bara) – inlet pressure piping loss (barg)
- K<sub>sh</sub> = Capacity correction factor due to the degree of superheat in the steam. For saturated steam use 1.0. See Chapter 8 Section V
- K<sub>n</sub> = Capacity correction factor for dry saturated steam at set pressures above 103 bara. See Chapter 8 Section III
- K<sub>b</sub> = Back pressure correction factor for gas. See Chapter 8 Section II

**ASME Section I (Set Pressures ≥ 1.03 barg)**

The sizing and selection of steam safety valves for fired pressure vessels that fall under the scope of ASME Section I has a different procedure than an ASME Section VIII steam sizing case. The steam sizing equation listed above could be used, but there are certain valve selection rules within ASME Section I where the use of valve capacity charts provides for a simpler procedure.

**Steam drum safety valve sizing**

The steam drum is one such fired pressure vessel that receives the saturated steam from water that has been heated by burning an external fuel source such as coal or natural gas. The boiler system may consist of only this steam drum or may have other vessels used to heat that we will discuss below. For the purposes of this initial discussion, let us assume the boiler system has only a steam drum. As with the sizing procedures discussed previously, the required steam relieving rate must be determined to size the drum safety valve. This is fairly straight forward as, in most instances, the required capacity shall not be smaller than the maximum designed steaming output of the boiler at its MAWP.

The user should refer to the catalog where the saturated steam capacity tables are located. The following link will provide access to the Crosby HL, HSJ, HCI and HE steam safety valves:

<http://www.valves.emerson.com/Images/CROMC-0295-US.pdf>

Although the determination of required capacity is often simple, the selection process is more involved as there are rules to be followed in the ASME Section I Code. One such requirement is that if a boiler system has a combined bare tube and extended heating surface exceeding

47 square meters, and a design steaming generation capacity exceeding 1800 kg/hr, then the drum must have two or more safety valves. If there are to be no more than two safety valves installed, there is a requirement in ASME Section I that the relieving capacity of the smaller valve be at least 50% or greater of that of the larger valve. Beyond this requirement, there are no other rules on how the overall required capacity is to be divided between multiple valves but it is often found that the capacity be evenly split between the multiple valves. This will allow the valves to be of the same configuration which can optimize the use of spare parts for maintenance.

These same selection rules in Section I apply when the boiler system has additional vessels in its train. However, there are additional requirements to consider that will be discussed next for the superheater, reheater and economizer.

**Superheater safety valve sizing**

As shown in Figure 6-1, when the steam created in the drum is being used to turn a turbine to create work, the steam drum outlet is often, but not always, attached to a heat exchanger vessel called a superheater. The moisture in saturated steam coming from the drum can cause corrosion and damage to the turbine blades. Therefore, the use of a superheater allows the hot flue gases from the boiler to continue to heat the wet steam to temperatures above saturation thus drying the fluid. The rules in ASME Section I state that all superheaters must have one or more safety valves located on the outlet of the superheater and prior to the first downstream isolation valve. The Code goes further to state that if there are no intervening stop valves between the steam drum and the superheater, then the superheater safety valve can be included in providing the relieving capacity for the entire system. This superheater safety valve, along with the drum valve, will satisfy the Code requirement for multiple valves for the larger boiler systems outlined in the previous steam drum discussion. What changes is the allowable split of the required capacity to be delivered by these multiple valves. ASME Section I mandates that for a boiler system, the drum safety valve provide a minimum of 75% of the available relieving capacity. The reason the Code limits the superheater safety valve available capacity is to protect this exchanger. Damage to the tubes in the exchanger can occur if the incoming saturated steam from the drum cannot make up the flow from the superheater safety valves that may have opened. The tubes in the superheater can overheat and fatigue because of the lack of heat transfer. This is an important consideration

since the superheater valves are set to open before the drum valves because of inlet pressure losses between the upstream drum and the downstream superheater. If an overpressure event occurs, the opening of the safety valves on dry superheated steam is preferable to opening the drum valves on wet steam.

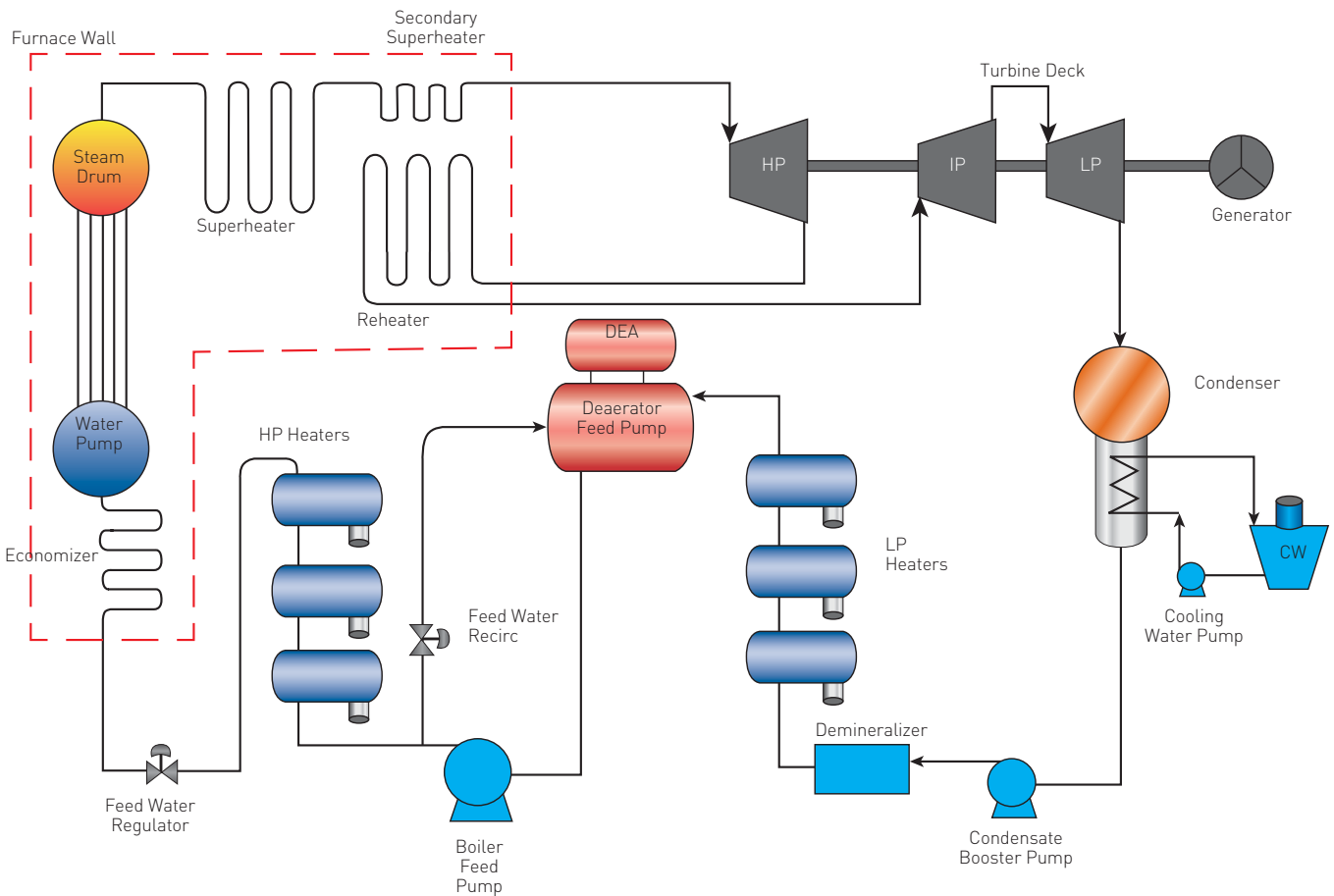


FIGURE 6 - 1  
 Closed Simple Rankine Steam Cycle

# PRESSURE RELIEF VALVE ENGINEERING HANDBOOK

## CHAPTER 6 – VALVE SIZING AND SELECTION – METRIC UNITS

Emerson engineering recommends the use of multiple steam drum valves when a superheater is part of the boiler system. These multiple drum valves should be set with the staggered values allowed by the Code and selected using the capacity mandate where a smaller orifice valve should have at least 50% or greater capacity of the larger orifice valve. This staged relief of steam pressure can help prevent the ingress of water into the steam trim safety valves during an opening cycle. Please note that this two or more drum valve arrangement is not required by Code but in many instances the required capacity will simply be too large for one drum safety valve.

A sample calculation and selection of drum and superheater safety valves follows:

### Step One

Determine the boiler specifications.

1. Total boiler steam generation: 660,000 kg/hr.
2. Boiler drum and superheater design pressure (MAWP): 206.0 barg
3. Drum operating pressure: 196.0 barg
4. Superheater outlet temperature: 550°C
5. Superheater outlet operating pressure: 185.0 barg
6. Boiler system bare tube and extended heating surface exceeds 47 sq.m.

### Step Two

Determine the capacity of the drum safety valves.

1. A minimum of 75% of the boiling steaming capacity must be relieved from the drum safety valves:  $660,000 \text{ kg/hr} \times 0.75 = 495,000 \text{ kg/hr}$ .

### Step Three

Select the drum safety valves with primary valve set at the MAWP.

1. Since we have more than 47 square meters of bare tube and heating surface and our steam generation is greater than 1800 kg/hr Emerson engineering recommends to use a minimum of two drum valves.
2. As you recall, ASME Section I allows for 6% accumulation when multiple valves are used. The first or primary valve can be set no higher than MAWP of 206.0 barg in this example. The secondary valve can be set 3% higher than MAWP or 212.2 barg.
3. As mentioned earlier it may be preferable, but not required, to have the same size drum valves to facilitate effective use of spare parts. Therefore, for this example we will split the drum capacity evenly between two safety valves:  $495,000 \text{ kg/hr} \div 2 = 247,500 \text{ kg/hr}$ .
4. Refer to Crosby Safety Valve catalogs for capacity charts to select the drum safety valves. Table 6-3 provides an example. The Crosby HE valve is suitable for drum applications at these set pressures. "M" orifice valves will provide 266,107 kg/hr at 206 barg set. Interpolation between 212 and 213 barg in the capacity chart will provide the available capacity at 212.2 barg for the secondary valve. The capacity at 212.2 barg will be 279,115 kg/hr. It should be noted that the capacity charts will show the capacity in saturated steam already adjusted using the Kn high pressure (103 bara and above set pressures) factor.

### Step Four

Determine the superheater safety valve set pressure.

1. Subtract the superheater outlet operating pressure from the drum outlet operating pressure to obtain the pressure loss in the piping between these devices:  
 $196.0 \text{ barg} - 185.0 \text{ barg} = 11.0 \text{ barg}$ .
2. As mentioned above, it is desirable to open the superheater safety valve first followed by the drum safety valve if necessary. Emerson engineering recommends that an additional 1.40 barg be included in the drum to superheater pressure drop to allow this to occur. It should be noted that this 1.40 barg additional pressure difference is not mandated by the ASME Section I Code but it is strongly recommended by Emerson. Therefore the total superheater pressure differential from the drum is the pressure loss plus the Emerson recommended 1.40 barg factor:  $11.0 \text{ barg} + 1.40 \text{ barg} = 12.4 \text{ barg}$ .
3. Calculate the superheater set pressure by subtracting the total drum to superheater pressure differential from the design (MAWP) pressure:  $206.0 \text{ barg} - 12.4 \text{ barg} = 193.6 \text{ barg}$ .

**TABLE 6-2 – ASME Section I Drum and Superheater Sizing Example Summary**

Location	Orifice Size	Set Pressure		Rated Relieving Capacity (kg/hr steam)	% of Total Required Capacity (660,000 kg/hr)
		(barg)	Temperature		
Low Set Drum Safety Valve	M	206.0	Saturated Steam	266,107	
High Set Drum Safety Valve	M	212.2	Saturated Steam	279,115	
<b>Total Flow thru Drum Safety Valve</b>				<b>545,222</b>	<b>83%</b>
Superheater Outlet Safety Valve	K2	193.6	550°C	120,668	18%
<b>Total Flow thru all Safety Valves</b>				<b>665,890</b>	<b>101%</b>

**Step Five**

Determine the superheater required relieving capacity.

1. The remaining capacity to be provided by the superheater is the difference between the total steam generation and rated capacity of the drum safety valves that have been selected:  
 $660,000 \text{ kg/hr} - 266,107 \text{ kg/hr} - 279,511 \text{ kg/hr} = 114,382 \text{ kg/hr}$ .
2. The superheat correction factor must be determined because the superheater safety valves are operating and will be flowing above the saturation point.
  - a. The superheater safety flowing pressure (bara) will be the set point + overpressure + atmospheric:  
 $193.6 \text{ barg} \times 1.03 + 1 \text{ bara} = 200.4 \text{ bara}$
  - b. At 550°C and 200.4 bara, the superheat correction factor is 0.704 from Chapter 8 Section V
3. In order to use the saturated steam capacity chart in Table 6-3 to select the superheater safety valve, we must convert the remaining required capacity to saturated conditions. Therefore, equivalent saturated steam required capacity at the superheated condition at 550°C is:  $114,382 \text{ kg/hr} \div 0.704 = 162,474 \text{ kg/hr}$  saturated steam.

**Step Six**

Select the superheater safety valve.

1. Refer to Crosby Safety Valve catalogs for capacity charts to select the superheater safety valve. Table 6-3 provides an example. The Crosby HCl valve is suitable for superheater outlet applications at a set pressure of 193.6 barg.
2. From the chart, interpolation will show that a "K2" orifice will provide 171,404 kg/hr of saturated steam and meet the requirement from step five.
3. At the 550°C superheat condition, this Crosby HCl "K2" orifice valve that has been selected will flow:  $171,404 \text{ kg/hr}$  saturated steam  $\times$  0.704 = 120,668 kg/hr superheated steam.

**Step Seven**

Check to ensure we meet the ASME Section I requirement that drum safety valves flow at least 75% of the total boiler steaming capacity and that the combined relieving capacity of all safety valves meet or exceed the required steaming capacity of the boiler. See Table 6-2 that summarizes the drum and superheater safety valve selection.

**Reheater safety valve sizing**

In Figure 6-1, there is another heat exchanger, called a reheater, that will add efficiency to the steam cycle by taking spent, near saturated steam from the turbine and adding more heat from the exhaust gases of the boiler. A closed steam cycle may or may not have a reheater.

The reheater operates similar to the superheater exchanger to superheat this incoming steam. This superheated steam exiting the reheater is at a much lower pressure than that at the superheater outlet but its temperature is virtually the same. This lower pressure, superheated steam from the reheater outlet is then sent back to the turbine deck where an intermediate pressure turbine will expand the steam and do additional work.

The ASME Section I Code requires each reheater to have one or more safety valves. The overall required capacity must be equal or greater than the maximum steam flow for which the reheater is designed. Unlike the superheater safety valves, there can be no credit taken for the reheater safety valves capacity in providing protection for the steam drum.

The reheater safety valves can be located either on the reheater inlet line that returns saturated steam back from the high pressure turbine or on the outlet line that delivers superheated steam back to the intermediate pressure turbine. One rule in ASME Section I will state that at least one safety valve be located on the outlet of the reheater prior to the first isolation valve and that this reheater outlet safety valve provide a minimum of 15% of the total required capacity. This requirement will protect the tubes of the reheater when the safety valves must lift. Similar to the superheater outlet safety valve, the reheater outlet safety valve is set lower than the reheater inlet valve to allow for the pressure drop through the exchanger and allow for the exhaust of the dry superheated steam to occur first. One might rightly assume it to be a good practice to have 100% of the required relieving capacity be from the reheater outlet valve as there is no restriction in ASME Section I for this type of installation. One reason for not installing the safety valves in this fashion is that these reheater outlet valves are more expensive devices than the reheater inlet valves. This is because the high superheated temperatures on the reheater outlet require a high alloy steel bill of materials so most specifications try and keep this valve as small as possible. An example of a reheater sizing and selection follows.

**Step One**

Determine the reheater specifications.

1. Reheater maximum design steam flow: 450,000 kg/hr
2. Design pressure: 50.0 barg
3. Reheater inlet operating pressure: 46.5 barg
4. Reheater outlet operating pressure: 44.8 barg
5. Reheater outlet operating temperature: 550°C

**Step Two**

Determine the reheater outlet safety valve set pressure.

1. Subtract the reheater outlet operating pressure from the reheater inlet operating pressure to obtain the pressure loss between these locations:  $46.5 \text{ barg} - 44.8 \text{ barg} = 1.70 \text{ barg}$ .
2. As mentioned above, it is desirable to open the reheater outlet safety valve first followed by the reheater inlet safety valve if necessary. Emerson engineering recommends that an additional 1.03 barg be included in the pressure drop to allow this to occur. It should be noted that this 1.03 barg additional pressure difference is not mandated by the ASME Section I Code. Therefore the total reheater inlet to outlet pressure differential is the pressure loss plus the Emerson recommended 1.03 barg factor:  $1.70 \text{ barg} + 1.03 \text{ barg} = 2.73 \text{ barg}$ .
3. Calculate the reheater outlet safety valve set pressure by subtracting the reheater pressure differential from the design pressure:  
 $50.0 \text{ barg} - 2.73 \text{ barg} = 47.3 \text{ barg}$ .

PRESSURE RELIEF VALVE ENGINEERING HANDBOOK  
 CHAPTER 6 – VALVE SIZING AND SELECTION – METRIC UNITS

**SATURATED STEAM CAPACITIES: STYLES HE, HCI AND HSJ - METRIC UNITS**

Kilograms per hour at 3% overpressure

**TABLE 6-3 – Saturated Steam Capacities - Set Pressures 173-213 barg**

Orifice Designation and Area (sq. mm.)																			
HE	•																		
HCI	•																		
HSJ	•																		
Orifice (sq mm)(barg)																			
Set Pres.	F	G	H	H2	J	J2	K	K2	L	L2	M	M2	N	P	P2	Q	Q2	R	RR
	198.1	324.5	506.5	641.3	830.0	923.2	1187.1	1641.9	1840.6	2155.5	2322.6	2565.2	2800.6	4116.1	4561.3	7125.8	7903.2	10322.6	12445.1
173	17748	29078	45381	57463	-	82726	106371	147127	-	193143	208116	229853	-	-	408717	-	-	-	-
174	17881	29296	45721	57893	-	83346	107167	148228	-	194589	209674	231574	-	-	411777	-	-	-	-
175	18014	29515	46062	58326	-	83969	107968	149336	-	196044	211242	233305	-	-	414856	-	-	-	-
176	18149	29736	46406	58762	-	84596	108774	150451	-	197508	212819	235047	-	-	417953	-	-	-	-
177	18284	29957	46753	59200	-	85227	109586	151574	-	198981	214407	236800	-	-	421071	-	-	-	-
178	18420	30181	47101	59641	-	85862	110402	152703	-	200464	216004	238565	-	-	424208	-	-	-	-
179	18557	30405	47452	60085	-	86501	111224	153840	-	201956	217612	240341	-	-	427366	-	-	-	-
180	18696	30631	47805	60532	-	87144	112051	154984	-	203459	219231	242129	-	-	430546	-	-	-	-
181	18835	30859	48160	60982	-	87792	112884	156136	-	204971	220861	243929	-	-	433746	-	-	-	-
182	18974	31088	48518	61435	-	88445	113723	157297	-	206494	222502	245741	-	-	436969	-	-	-	-
183	19115	31319	48878	61892	-	89101	114568	158465	-	208028	224154	247566	-	-	440214	-	-	-	-
184	19257	31552	49241	62351	-	89763	115418	159641	-	209572	225819	249404	-	-	443483	-	-	-	-
185	19400	31786	49607	62814	-	90429	116275	<b>160826</b>	-	211128	227495	251256	-	-	446775	-	-	-	-
186	19544	32022	-	63280	-	91101	117138	162020	-	212695	229184	253121	-	-	450092	-	-	-	-
187	19689	32260	-	63750	-	91777	118008	163223	-	214274	230885	255000	-	-	453433	-	-	-	-
188	-	-	-	64223	-	92458	118884	164435	-	215865	232600	256893	-	-	456800	-	-	-	-
189	-	-	-	64700	-	93145	119767	165656	-	217469	234327	258801	-	-	460192	-	-	-	-
190	-	-	-	65181	-	93837	120657	166887	-	219085	236068	260724	-	-	463612	-	-	-	-
191	-	-	-	65666	-	94535	121554	168128	-	220714	237824	262663	-	-	467059	-	-	-	-
192	-	-	-	66154	-	95238	122459	169379	-	222356	239593	264617	-	-	470534	-	-	-	-
193	-	-	-	66647	-	95948	123371	170640	-	224012	241377	266588	-	-	474039	-	-	-	-
194	-	-	-	67144	-	96663	124290	<b>171913</b>	-	225682	243177	268575	-	-	477572	-	-	-	-
195	-	-	-	67645	-	97384	125218	<b>173196</b>	-	227366	244992	270580	-	-	481137	-	-	-	-
196	-	-	-	68150	-	98112	126154	174490	-	229065	246822	272602	-	-	484732	-	-	-	-
197	-	-	-	68660	-	98846	127098	175796	-	230779	248670	274642	-	-	488359	-	-	-	-
198	-	-	-	69175	-	99587	128050	177113	-	232509	250533	276700	-	-	492020	-	-	-	-
199	-	-	-	69694	-	100335	129012	178443	-	234255	252415	278778	-	-	495714	-	-	-	-
200	-	-	-	70219	-	101090	129982	179785	-	236017	254313	280875	-	-	499443	-	-	-	-
201	-	-	-	70748	-	101852	130962	181141	-	237796	256230	282992	-	-	503208	-	-	-	-
202	-	-	-	71282	-	102621	131951	182509	-	239592	258166	285130	-	-	507009	-	-	-	-
203	-	-	-	71822	-	103398	132951	183891	-	241407	260121	287289	-	-	510849	-	-	-	-
204	-	-	-	72368	-	104183	133960	185287	-	243239	262096	289470	-	-	514727	-	-	-	-
205	-	-	-	72918	-	104976	134980	186697	-	245091	264091	291673	-	-	518645	-	-	-	-
206	-	-	-	73475	-	105777	136010	188123	-	246962	<b>266107</b>	293900	-	-	522604	-	-	-	-
207	-	-	-	74038	-	106587	137051	189563	-	248853	268144	296150	-	-	526605	-	-	-	-
208	-	-	-	-	-	-	138104	191019	-	-	270204	298425	-	-	530651	-	-	-	-
209	-	-	-	-	-	-	139169	192492	-	-	272287	300725	-	-	534741	-	-	-	-
210	-	-	-	-	-	-	140245	193981	-	-	274393	303052	-	-	538877	-	-	-	-
211	-	-	-	-	-	-	141334	195487	-	-	276523	305405	-	-	543061	-	-	-	-
212	-	-	-	-	-	-	142436	197011	-	-	<b>278679</b>	307785	-	-	547294	-	-	-	-
213	-	-	-	-	-	-	143551	198553	-	-	<b>280860</b>	310195	-	-	551578	-	-	-	-

**Step Three**

Determine the capacity of the reheater outlet safety valve.

1. A minimum of 15% of the relieving capacity must come from the reheater outlet safety valve: 450,000 kg/hr x 0.15 = 67,500 kg/hr.
2. The superheat correction factor must be determined because the reheater outlet safety valves are operating, and will be flowing, above the saturation point.
  - a. The reheater safety valve flowing pressure (bara) will be the set point + overpressure + atmospheric: 47.3 barg x 1.03 + 1.01 bara = 49.7 bara
  - b. At 550°C and 49.7 bara the superheat correction factor is 0.751 from Chapter 8 Section V

3. In order to use the saturated steam capacity chart such as that shown in Table 6-5 to select the reheater outlet safety valve, we must convert the required capacity to saturated conditions. Therefore, equivalent saturated steam required capacity at the superheated condition at 550°C is: 67,500 kg/hr ÷ 0.751 = 89,880 kg/hr saturated steam.

**Step Four**

Select the reheater outlet safety valve.

1. From Table 6-5 one "P" orifice Crosby HCI safety valve will provide 99,073 kg/hr at 49.7 barg.
2. At the 550°C superheat condition, this Crosby HCI "P" orifice valve that has been selected will flow:  $99,073 \text{ kg/hr saturated steam} \times 0.751 = 74,404 \text{ kg/hr superheated steam}$ .

**Step Five**

Determine the reheater inlet safety valve required relieving capacity.

1. The remaining capacity to be provided by the reheater inlet safety valves is the difference between the design steam flow and rated capacity of the reheater outlet that has been selected:  $450,000 \text{ kg/hr} - 74,404 \text{ kg/hr} = 375,596 \text{ kg/hr}$ .

**Step Six**

1. Refer again to Crosby Safety Valve catalogs (see Table 6-5) for capacity charts to select the reheater inlet safety valves. The Crosby HCI valve is suitable for reheater inlet applications at these set pressures. You will note there is not one valve that can provide the remaining required capacity. Therefore, we need to consider multiple valves. Many specifying engineers will select identical valves to optimize spare parts.
2. Divide the remaining required capacity for the reheater in half:  $375,596 \text{ kg/hr} \div 2 = 187,798 \text{ kg/hr}$ .
3. As you recall, ASME Section I allows for 6% accumulation when multiple valves are used. The first or primary reheater inlet valve can be set no higher than MAWP of 50.0 barg in this example. The secondary valve can be set 3% higher than MAWP or 51.5 barg.
4. "Q2" orifice valves will provide 191,352 kg/hr at 50.0 barg set and 196,982 kg/hr at 51.5 barg set. See Table 6-5.

**Step Seven**

Check to ensure we meet the ASME Section I requirement that reheater outlet safety valve will flow at least 15% of the total reheater design steam flow, and that the combined relieving capacity of the reheater inlet and reheater outlet safety valves meet or exceed the total steam flow of the reheater. Table 6-4 summarizes the reheater inlet and outlet safety valve selection.

**Economizer safety valve sizing**

You will note in Figure 6-1 that there is one other heat exchanger vessel that is located upstream of the steam drum portion of the steam cycle. As with the superheater and reheater sections of the cycle, hot flue gases are used to add heat to the incoming boiler feedwater. This helps to reduce the amount of energy needed to raise the temperature of the water as it travels to the steam drum.

In many installations there is no intervening isolation valve between the economizer and the steam drum. When this is the case, the safety valves on the steam drum, sized and selected as described above, can be used as overpressure protection for the economizer.

In some steam cycles, such as combined cycle type plants, it may be necessary to regulate the output of the economizer into the boiler to meet varying needs. This requirement now adds valves that could potentially isolate the economizer from the boiler. In this case the ASME Section I Code mandates that the economizer have one or more safety relief valves. The rated capacity of these safety relief valves is determined by the economizer manufacturer based upon the maximum heat absorption rate. For metric units of measure, the heat absorption rate in Watts is divided by 1.6 to obtain the required steam capacity in kg/hr. Once again, use the saturated steam tables to select a safety valve that will have a rated capacity equal to or larger than the required capacity.

**TABLE 6-4 – ASME SECTION I REHEATER SIZING EXAMPLE SUMMARY**

Location	Orifice Size	Set Pressure (barg)	Temperature	Rated Relieving Capacity (kg/hr steam)	% of Total Required Capacity (450,000 kg/hr)
Low set reheater inlet safety valve	Q2	50.0	Saturated Steam	191,352	
High set reheater inlet safety valve	Q2	51.5	Saturated Steam	196,982	
<b>Total Flow Thru Reheater inlet Safety Valves</b>				<b>388,334</b>	
Reheater Outlet Safety Valve	P	47.3	550°C	74,404	17%
<b>Total Flow Thru all Safety Valves</b>				<b>462,738</b>	<b>103%</b>



PRESSURE RELIEF VALVE ENGINEERING HANDBOOK  
 CHAPTER 6 – VALVE SIZING AND SELECTION – METRIC UNITS

**SATURATED STEAM CAPACITIES: STYLES HE, HCI AND HSJ – METRIC UNITS**

Kilograms per hour at 3% overpressure

**TABLE 6-5 – Saturated Steam Capacities - Set Pressures 44-86 barg**

Orifice Designation and Area (sq. mm.)																			
HE																			
HCI																			
HSJ																			
Orifice (sq mm)(barg)																			
Set	F	G	H	H2	J	J2	K	K2	L	L2	M	M2	N	P	P2	Q	Q2	R	RR
Pres.	198.1	324.5	506.5	641.3	830.0	923.2	1187.1	1641.9	1840.6	2155.5	2322.6	2565.2	2800.6	4116.1	4561.3	7125.8	7903.2	10322.6	12445.1
44	4231	6932	10819	13700	17752	19722	25359	35076	39321	46047	49616	54798	59829	87931	97441	-	168833	220517	265860
45	4325	7087	11060	14004	18146	20161	25923	35856	40195	47070	50719	56017	61159	89886	99607	-	172586	225419	271770
46	4419	7241	11300	14309	18541	20599	26487	36635	41069	48094	51822	57235	62489	91840	101773	-	176339	230321	277680
47	4513	7395	11541	14613	18935	21038	27051	37415	41943	49117	52925	58453	63819	93795	103939	-	180093	235223	283591
48	4607	7549	11781	14918	19330	21476	27614	38195	42817	50141	54028	59671	65149	95750	106105	-	183846	240125	289501
49	4701	7703	12022	15222	19725	21915	28178	38975	43691	51165	55131	60889	66479	97705	108271	-	187599	245027	295411
50	4796	7857	12262	15527	20119	22353	28742	39754	44566	52188	56234	62107	67809	99659	110437	-	191352	249929	301321
51	4890	8011	12503	15831	20514	22791	29306	40534	45440	53212	57337	63326	69139	101614	112604	-	195105	254831	307231
52	4984	8165	12743	16136	20909	23230	29869	41314	46314	54236	58440	64544	70469	103569	114770	-	198858	259733	313141
53	5078	8319	12984	16440	21303	23668	30433	42094	47188	55259	59543	65762	71799	105523	116936	-	202612	264636	319051
54	5172	8474	13224	16745	21698	24107	30997	42873	48062	56283	60646	66980	73129	107478	119102	-	206365	269538	324961
55	5266	8628	13465	17050	22092	24545	31561	43653	48936	57306	61749	68198	74459	109433	121268	-	210118	27443:	330871
56	5360	8782	13705	17354	22487	24984	32124	44433	49810	58330	62852	69416	75789	111388	123434	-	213871	279342	336781
57	5454	8936	13946	17659	22882	25422	32688	45213	50684	59354	63955	70635	77119	113342	125600	-	217624	284244	342692
58	5548	9090	14186	17963	23276	25860	33252	45992	51558	60377	65058	71853	78449	115297	127766	-	221377	289146	348602
59	5642	9244	14427	18268	23671	26299	33816	46772	52432	61401	66161	73071	79779	117252	129933	-	225131	294048	354512
60	5736	9398	14667	18572	24065	26737	34379	47552	53307	62425	67264	74289	81109	119206	132099	-	228884	298950	360422
61	5830	9552	14908	18877	24460	27176	34943	48332	54181	63448	68367	75507	82439	121161	134265	-	232637	303852	366332
62	5924	9706	15148	19181	24855	27614	35507	49111	55055	64472	69470	76725	83769	123116	136431	-	236390	308754	372242
63	6018	9861	15389	19486	25249	28053	36071	49891	55929	65495	70573	77944	85099	125071	138597	-	240143	313657	378152
64	6112	10015	15629	19790	25644	28491	36634	50671	-	66519	-	79162	-	-	140763	-	243896	318559	-
65	6206	10169	15870	20095	26039	28930	37198	51450	-	67543	-	80380	-	-	142929	-	247650	323461	-
66	6300	10323	16110	20400	26433	29368	37762	52230	-	68566	-	81598	-	-	145095	-	251403	328363	-
67	6395	10477	16351	20704	26828	29806	38325	53010	-	69590	-	82816	-	-	147261	-	255156	333265	-
68	6489	10631	16591	21009	27222	30245	38889	53790	-	70614	-	84035	-	-	149428	-	258909	338167	-
69	6583	10785	16832	21313	27617	30683	39453	54569	-	71637	-	85253	-	-	151594	-	262662	343069	-
70	6677	10939	17072	21618	28012	31122	40017	55349	-	72661	-	86471	-	-	153760	-	266416	347971	-
71	6771	11093	17313	21922	28406	31560	40580	56129	-	73684	-	87689	-	-	155926	-	270169	352873	-
72	6865	11248	17553	22227	28801	31999	41144	56909	-	74708	-	88907	-	-	158092	-	273922	357775	-
73	6959	11402	17794	22531	29196	32437	41708	57688	-	75732	-	90125	-	-	160258	-	277675	362678	-
74	7053	11556	18034	22836	29590	32875	42272	58468	-	76755	-	91344	-	-	162424	-	281428	367580	-
75	7147	11710	18275	23140	29985	33314	42835	59248	-	77779	-	92562	-	-	164590	-	285181	372482	-
76	7241	11864	18515	23445	30379	33752	43399	60028	-	78802	-	93780	-	-	166757	-	288935	377384	-
77	7335	12018	18756	23750	30774	34191	-	60807	-	79826	-	94998	-	-	168923	-	292688	382286	-
78	7429	12172	18996	24054	31169	34629	-	61587	-	80850	-	96216	-	-	171089	-	296441	387188	-
79	7523	12326	19237	24359	31563	35068	-	62367	-	81873	-	97434	-	-	173255	-	300194	392090	-
80	7617	12480	19477	24663	31958	35506	-	63147	-	82897	-	98653	-	-	175421	-	303947	396992	-
81	7711	12635	19718	24968	32353	35944	-	63926	-	83921	-	99871	-	-	177587	-	307700	401894	-
82	7805	12789	19958	25272	32747	36383	-	64706	-	84944	-	101089	-	-	179753	-	311454	406797	-
83	7899	12943	20199	25577	33142	36821	-	65486	-	85968	-	102307	-	-	181919	-	315207	411699	-
84	7994	13097	20439	25881	33536	37260	-	66266	-	86991	-	103525	-	-	184085	-	318960	-	-
85	8088	13251	20680	26186	33931	37698	-	67045	-	88015	-	104743	-	-	186252	-	322713	-	-
86	8182	13405	20920	26490	34326	38137	-	67825	-	89039	-	105962	-	-	188418	-	326466	-	-

**V. LIQUID SIZING**

The following formula is used for sizing relief valves for liquid service at any set pressure. The flow of an incompressible fluid (that does not flash) through an orifice is based upon the square root of the differential pressure across that orifice. There is a correction factor for highly viscous liquids as well as a back pressure correction factor for balanced bellows relief valves.

$$A = \frac{19.633 V_L \sqrt{G}}{K K_V K_W \sqrt{P_1 - P_2}}$$

Where:

- A = Minimum required discharge area, square millimeters
- V<sub>L</sub> = Required relieving capacity, m<sup>3</sup>/hr at flowing temperature
- K = Coefficient of discharge. See Chapter 8 Section IX
- K<sub>V</sub> = Capacity correction factor due to viscosity of the fluid at flowing conditions. For most applications viscosity will not affect the area calculation so K<sub>V</sub> will be equal to 1.0. See Chapter 8 Section IV for more information
- K<sub>W</sub> = Capacity correction factor for balanced direct spring relief valves due to back pressure. Use K<sub>W</sub> equal to 1.0 for conventional direct spring and pilot operated relief valves. See Figures 8-11, 8-14 and 8-19
- G = Specific gravity of service liquid at flowing temperature referred to water at standard conditions (15.5°C and 1.013 bara)
- P<sub>1</sub> = Inlet pressure during flow, set pressure (barg) + overpressure (barg) – inlet pressure loss (barg)
- P<sub>2</sub> = Total back pressure during flow (barg)

**Thermal Relief Sizing**

One very common application for a liquid service relief valve is protecting equipment, such as piping, from hydraulic expansion of the service fluid. This overpressure contingency is commonly referred to as thermal relief and can be caused by heat transfer from one process media to another or by solar radiation. ISO 23251 states that the required relieving rate is difficult to calculate and that a portable ¾" x 1" valve is very commonly installed to provide protection.

The standard does give some cautions with regards to large diameter liquid pipelines where the distance between isolation devices may be long or where the application concerns liquid filled heat exchangers and vessels. If physical properties are known, the required relieving capacity for thermal relief can be calculated as follows. This flow rate can then be used in the liquid sizing formula above.

$$V_L = \frac{3.6 \alpha_v \phi}{G c}$$

Where:

- V<sub>L</sub> = Volume flow rate at the flowing temperature, m<sup>3</sup>/hr
- α<sub>v</sub> = Cubic expansion coefficient of the trapped liquid at the expected temperature, expressed in 1/°C
- φ = Total heat transfer rate, W
- G = Specific gravity of service liquid at flowing temperature referred to water at standard conditions
- c = Specific heat capacity of the trapped fluid, J/kg-K

**VI. FIRE SIZING**

In the first part of this chapter it was noted that one of the starting points in sizing pressure relief devices is to determine the required capacity for various possible causes of overpressure. One common overpressure contingency to be considered is subjecting a storage tank or process vessel to an external fire that could raise the temperature of the contents in the tank or vessel. This subsequently could increase the system pressure due to a liquid inside the vessel vaporizing or a gas inside the vessel expanding.

**Liquid Filled Tanks/Vessels**

The procedure that is normally used in determining the required relieving capacity will directly or indirectly calculate the estimated heat transfer from an external fire to the contents of the vessel. This calculated heat input value will vary from one code, standard, recommended practice, or statute to another. One reason for this difference in heat input values is that one particular publication may have a different definition to another for what is called the "wetted" surface area of the vessel exposed to the fire. There are also different assumptions made in the documents with regard to tank insulation, prompt fire fighting availability and drainage that can also alter the heat input calculations.

The exposed wetted surface is that part of the vessel or tank where the liquid contents reside and where a fire can input heat to vaporize the contents. The greater the exposed wetted surface area the greater the heat input, the greater the heat input the more vaporization can occur, the more vaporization the larger the required relief device orifice. Since this exposed wetted surface definition and various assumptions as noted above can vary from one engineering practice to another, it is important that the user be aware of what document is to be referenced for a particular installation and location. Some of the more common documents that are referenced and their calculation of exposed wetted surface area, required capacity, and required orifice area are as follows. It is recommended to review these documents, in full, for their scope of use and a more complete explanation of the assumptions made in providing this guidance.

**ISO 23251 – Pressure Relieving and Depressuring Systems**

**Step One**

Calculate the wetted surface area.

- Liquid Filled Vessels – calculate the wetted area as the exposed area of the vessel up to a maximum height of 7.6 meters from the location of the fire.
- Process Vessels – calculate the wetted area as the exposed area up to the normal liquid operating level. If the normal operating level exceeds 7.6 meters from the location of the fire, use 7.6 meters as the height for the wetted area calculation.
- Spheres – calculate the exposed area up to the maximum horizontal diameter (i.e. the equator) of the sphere and then calculate the exposed area up to a height of 7.6 meters from the location of the fire. Use the larger of the two areas as the wetted area.

**TABLE 6-6 – ENVIRONMENTAL FACTOR**

Tank Design/ Configuration	Insulation Conductance (W/m <sup>2</sup> • K)	Insulation Thickness (cm)	F
Bare Metal Tank	-	0	1.0
Insulated Tank	22.71	2.5	0.3
	11.36	5	0.15
	5.68	10	0.075
	3.80	15	0.05
	2.84	20	0.0375
	2.27	25	0.03
Water-Application Facilities	1.87	30	0.025
	-	-	1.0
Depressuring and Emptying Facilities	-	-	1.0
Underground Storage	-	-	0
Earth-Covered Storage Above Grade	-	-	0.03

**Note:** The insulation should not be dislodged by fire hose streams nor be combustible or decompose below 538°C.

**Step Two**

Calculate the heat absorption or input to the liquid.

- If there is deemed to be prompt firefighting and drainage of the flammable fuel of the fire away from the vessel, use the following equation:

$$Q = 43,200 F A_w^{0,82}$$

Where:

- Q = Total heat absorption (input) to the wetted surface, W
- F = Environmental factor (see Table 6-6)
- A<sub>w</sub> = Wetted surface area from step one above, square meters

- Where there is not prompt firefighting and not drainage of the flammable fuel of the fire away from the vessel, use the following equation:

$$Q = 70,900 F A_w^{0,82}$$

Where:

- Q = Total heat absorption (input) to the wetted surface, W
- F = Environmental factor (see Table 6-6)
- A<sub>w</sub> = Wetted surface area from step one above, square meters

**Step Three**

Determine the required relieving capacity.

$$W = 3600 \frac{Q}{L}$$

Where:

- Q = Total heat absorption (input) to the wetted surface, W
- L = Latent heat of vaporization, J/kg
- W = Required relieving capacity, kg/hr

**Step Four**

Since the primary scope of ISO 23251 is used for applications at or above 1.03 barg design pressures, size for the required orifice using the weight flow vapor equation from page 6.4.

Weight Flow (kg/hr)

$$A = \frac{W}{CKP_1 K_b K_c} \sqrt{\frac{TZ}{M}}$$

Use the physical properties of the service fluid in the equation. Please recall that for ASME Section VIII applications, the overpressure for fire sizing can be 21% if the valve is set at the MAWP. The allowable accumulation for PED applications is determined by the designer based upon good engineering practice.

**ISO 28300 – Venting of Atmospheric and Low Pressure Storage Tanks**

**Step One**

Calculate the wetted surface area.

- Spheres – calculate an area of 55% of the total exposed spherical area and then calculate the exposed area up to a height of 9.14 meters above grade. Use the larger of the two areas as the wetted area.
- Horizontal Tank – calculate an area of 75% of the total exposed area and then calculate the exposed area up to a height of 9.14 meters above grade. Use the larger of the two areas as the wetted area.
- Vertical Tank – calculate the wetted area as the exposed area up to a height of 9.14 meters above grade.

**Step Two**

Calculate the heat absorption or input to the liquid per Table 6-7. The formula used for this calculation will vary based upon the wetted surface area calculated in step one.

**TABLE 6-7 – ISO 28300 HEAT INPUT EQUATIONS**

Wetted Surface Area, $A_w$ (m <sup>2</sup> )	Design Pressure (barg)	Heat Input, Q (W)
< 18.6	≤ 1.03	63,150A <sub>w</sub>
> 18.6 and < 93	≤ 1.03	224,200A <sub>w</sub> <sup>0.566</sup>
> 93 and < 260	≤ 1.03	630,400A <sub>w</sub> <sup>0.338</sup>
> 260	Between 0.07 and 1.03	43,200A <sub>w</sub> <sup>0.82</sup>
> 260	≤ 0.07	4,129,700

Where:

- A<sub>w</sub> = wetted surface area from step one above, square meters
- Q = total heat absorption (input) to the wetted surface (W)

**Step Three**

Calculate the required venting capacity in Nm<sup>3</sup>/hr of equivalent air capacity using the following formula:

$$q = \frac{906.6QF}{L} \sqrt{\frac{T}{M}}$$

Where:

- q = Required relieving capacity in equivalent air, Nm<sup>3</sup>/hr.
- Q = Total heat absorption (input) to the wetted surface from step two, W
- F = Environmental factor (see Table 6-6)
- L = Latent heat of vaporization, J/kg
- T = Absolute temperature of the relieving vapor, °K
- M = Molecular weight of the relieving vapor

**Step Four**

ISO 28300 deals with storage tanks with design pressures less than 1.03 barg. Therefore, the equivalent air capacity in Nm<sup>3</sup>/hr calculated in step three can be directly used in the Whessoe Varc flow capacity charts to select the vent size. For Anderson Greenwood brand pilot operated valves, use the subsonic formula and inputs discussed on page 6.5. Volumetric Flow (Nm<sup>3</sup>/hr)

$$A = \frac{V \sqrt{MTZ}}{12,515K_d P_1 F}$$

Note that the capacity calculated in step three is Nm<sup>3</sup>/hr of equivalent air. The volumetric flow equation uses m<sup>3</sup>/hr. Since the capacity is in equivalent air, use M = 29, T = 0 + 273 = 273°K, Z = 1.0 and V = q from step 3 in the volumetric formula. Note that F in the volumetric flow equation is not the environmental factor from Table 6-6.

**Gas Filled Vessels**

ISO 23251 provides a recommended procedure for determining the required pressure relief area due to a gas filled vessel being exposed to external flames.

**Step One**

Calculate the total exposed surface area. This is the complete surface area of the gas filled vessel that is exposed to the ambient.

**Step Two**

Calculate what is termed the vapor fire sizing factor using the following:

$$F' = \frac{0.001518}{CK} \left[ \frac{(T_w - T_1)^{1.25}}{T_1^{0.6506}} \right]$$

Where:

- C = Gas constant based upon the ratio of specific heats of the gas or vapor at standard conditions. See Chapter 8 Section VI. Use C = 2.390 if unknown
  - K = Coefficient of discharge. See Chapter 8 Section IX
  - T<sub>w</sub> = Recommended maximum wall temperature of vessel material, °K
  - T<sub>1</sub> = Gas temperature at the upstream relieving pressure, °K
- This gas temperature can be found using

$$T_1 = \frac{P_1}{P_n} T_n$$

Where:

- P<sub>1</sub> = the upstream relieving pressure, set pressure + overpressure + atmospheric pressure, bara
- P<sub>n</sub> = the normal operating gas pressure, bara
- T<sub>n</sub> = the normal operating gas temperature, °K

*If insufficient data exists to calculate the F', use F' = 0.045*

**Step Three**

Calculate the minimum required pressure relief valve discharge area using:

$$A = \frac{1823.5F'A_w}{\sqrt{P_1}}$$

Where:

- A = Minimum required discharge area, square millimeters
- A<sub>w</sub> = Wetted surface area from step one, square meters

**VII. TWO-PHASE FLOW SIZING**

Two-phase flow describes a condition whereby a flow stream contains a fluid whose physical state is part liquid and part gas. For pressure relief applications it can be common for all or part of the liquid portion of the fluid to change to vapor, or flash, as the pressure drops. The ratio of gas to liquid in the flowing media can be a significant factor in determining the required orifice flow area of a pressure relief valve.

It is important to note that there are no codes such as ASME or PED, that require a certain methodology to be used to size PRVs for two phase flow regimes. The selection of the method for a particular case lies solely with the user that has the full knowledge of the process conditions.

There are several publications, written by various process relief experts, that will provide guidance in calculating the required relief load and the subsequent minimum required orifice area of the pressure relief valve. What is evident from these publications is that the subject is complex and that there is no single universally accepted calculation method that will handle every application. Some methods give what are considered to be accurate results over certain ranges of fluid quality, temperature and pressure. The inlet and outlet conditions of the pressure relief valve must be considered in more detail than what has been discussed up to now, where we have been dealing with a single phase fluid flow that does not change state.

It is therefore necessary that those responsible for the selection of pressure relief valves used for two-phase or flashing flow applications be knowledgeable of the total system and current on the latest best practices for multi-phase sizing techniques. The user should note that some of these sizing methods have not been substantiated by actual tests and there is no universally recognized procedure for certifying pressure relief valve capacities in two-phase flows.

This engineering handbook will discuss two of these sizing techniques. One is outlined in API 520 Part I (9th Edition – July 2014) Annex C and the other, from ASME Section VIII Appendix 11, which is specifically used for saturated water applications.

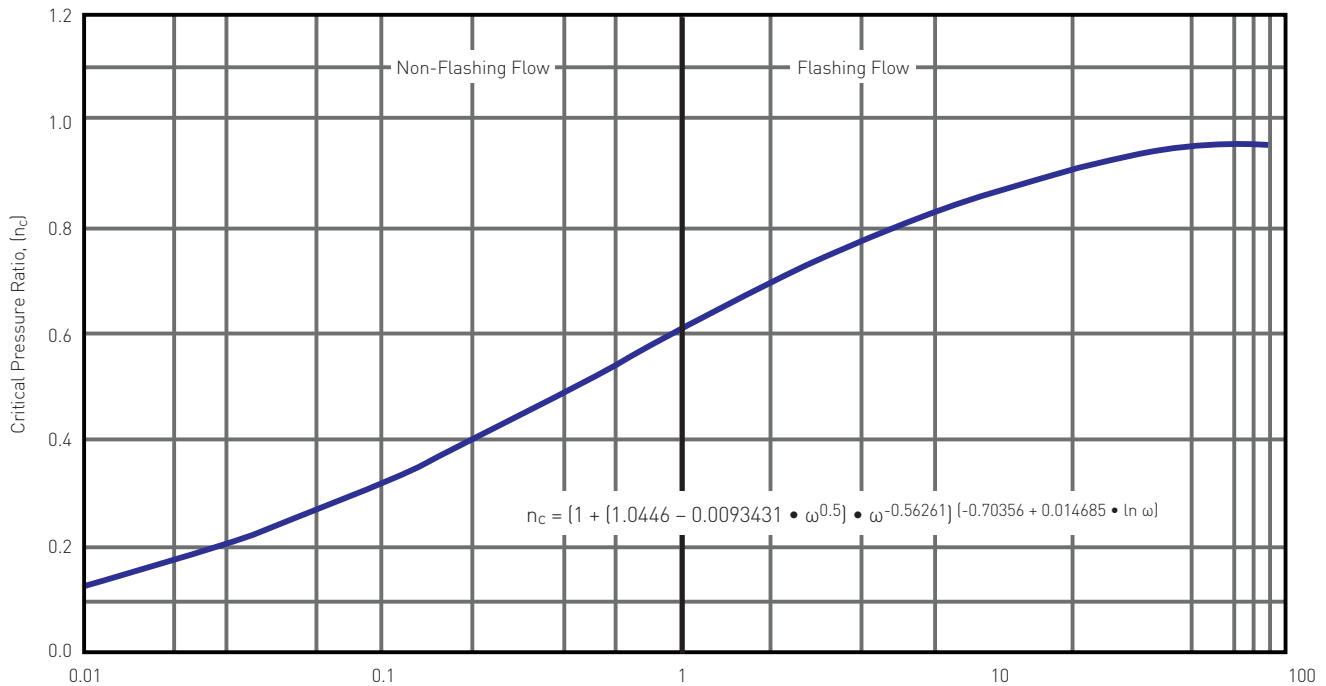


FIGURE 6-2  
 Omega Parameter,  $\omega$   
 Critical Pressure Ratio for Two-Phase Flow

**API Standard 520 Part I (9th Edition)**

One sizing procedure in Annex C is a part of what is commonly known as the “Omega Method” which was developed by Dr. J. Leung. The Omega Method is a simplified version of a more rigorous procedure called the Homogeneous Equilibrium Method (HEM) which assumes that the fluid is well mixed, and the gas and liquid portions of the fluid are flowing at the same velocity through the nozzle of the pressure relief valve. The fluid is also assumed to remain in thermodynamic equilibrium, which simply means that any flashing that occurs will take place when the pressure drops below the vapor pressure of the mixture. What is called the “reduced” Omega method in API Standard 520 Part I is a simplified technique in that one can take the process conditions at the pressure relief valve inlet and compare them to the process conditions at a lower pressure. This two process point comparison will represent the behavior of the mixture as the pressure drops during the opening of a pressure relief valve. The process conditions, such as the density or specific volume, at the inlet of the valve are known parameters from those on the PRV datasheet at set pressure. The second process data point required is the density or specific volume of the mixture at 90% of the flowing pressure or, in the case of 100% liquid that flashes it would be the saturation pressure at the relieving temperature. Note that the flowing pressure is taken as an absolute value. This data point is normally obtained from the fluid property database or from a process simulation flash calculation.

API 520 Part I will illustrate the use of the reduced Omega Method for two conditions. One condition is a two-phase mixture at the inlet of the PRV that may or may not flash during relief and the other condition is where a 100% liquid fluid at the inlet of the PRV flashes during relief.

**API Standard 520 Part I (9th Edition) – Two-Phase Flow Mixture Procedure**

**Step One**

Calculate the Omega parameter.

$$\omega = 9 \left( \frac{v_9}{v_1} - 1 \right)$$

Where:

- $v_9$  = specific volume of the two-phase fluid at 90% of the absolute flowing pressure, m<sup>3</sup>/kg
- $v_1$  = specific volume of the two-phase fluid at the absolute flowing pressure at the prv inlet, m<sup>3</sup>/kg

**Step Two**

Determine the critical pressure ratio from Figure 6-2 using  $\omega$  from step one. As you will note in the figure, the value of the Omega parameter will indicate whether the mixture will or will not flash.

**Step Three**

Calculate the critical pressure.

$$P_c = \eta_c P_1$$

Where:

- $P_c$  = Critical pressure, bara
- $\eta_c$  = Critical pressure ratio from step two
- $P_1$  = Set pressure + allowable overpressure + atmospheric pressure – inlet piping losses, bara

**Step Four**

Determine if flow is critical or subcritical by comparing critical pressure from step three to the expected total back pressure ( $P_2$ ) in bara. If  $P_c \geq P_2$  then flow is critical, go to step five. If  $P_c < P_2$  then flow is subcritical, go to step six.

**Step Five**

Calculate the required mass flux for the service fluid if in critical flow.

$$G = 1.138 \eta_c \sqrt{\frac{P_1}{v_1 \omega}}$$

Where:

- $G$  = Mass flux required, kg/hr-mm<sup>2</sup>
- $\eta_c$  = Critical pressure ratio from step three
- $P_1$  = Flowing pressure, i.e. set pressure + allowable overpressure + atmospheric pressure – inlet piping losses, bara
- $v_1$  = Specific volume of the two-phase service fluid at the set pressure, m<sup>3</sup>/kg
- $\omega$  = Omega parameter from step one

**Go to step seven.**

**TABLE 6-8 – ANDERSON GREENWOOD CROSBY SELECTION FOR TWO-PHASE FLOW**

Conventional Direct Spring PRV <sup>1</sup>	Balanced Direct Spring PRV	Pilot Operated PRV
JLT-JOS-E Series 900	JLT-JBS-E	Series 400/500/800

Note 1 – The magnitude of the built-up back pressure can be difficult to predict for two-phase flow. It is advisable to use either a balanced direct spring or pilot operated PRV if this value is uncertain.

**Step Six**

Calculate the required mass flux for the service fluid if in subcritical flow.

$$G = \frac{1.138 \sqrt{-2[\omega 1 n \eta_2 + (\omega - 1)(1 - \eta_2)]} \sqrt{P_1 / v_1}}{\omega \left( \frac{1}{\eta_2} - 1 \right) + 1}$$

Where:

- G = Required Mass flux, kg/hr-mm<sup>2</sup>
- P<sub>2</sub> = Total expected back pressure, bara
- P<sub>1</sub> = Flowing pressure, i.e. set pressure + allowable overpressure + atmospheric – inlet piping losses, bara
- n<sub>2</sub> = Back pressure ratio, P<sub>2</sub>/P<sub>1</sub>
- ω = Omega parameter from step one
- v<sub>1</sub> = Specific volume of the two-phase service fluid at the inlet of the valve at the flowing pressure, m<sup>3</sup>/kg

**Step Seven**

In order to help obtain the two-phase nozzle discharge coefficients and back pressure correction factors for the desired Anderson Greenwood Crosby brand product, we must first determine the mass fraction (x<sub>1</sub>) of the gas/ vapor portion of the two-phase mixture. From the mass fraction, we can determine what is called the void fraction (α<sub>1</sub>), or volume ratio of the gas/vapor to the total volume of the two-phase mixture. This void fraction will be used to calculate the two-phase nozzle coefficient and back pressure correction factors.

$$x_1 = \frac{W_G}{W_L + W_G}$$

Where:

- x<sub>1</sub> = Mass fraction of gas/vapor portion of two-phase mixture
- W<sub>G</sub> = Required gas/vapor mass flow, kg/hr
- W<sub>L</sub> = Required liquid mass flow, kg/hr

$$\alpha_1 = \frac{x_1 v_{v1}}{v_1}$$

Where:

- α<sub>1</sub> = Void fraction of two-phase mixture
- x<sub>1</sub> = Mass fraction from above calculation
- v<sub>v1</sub> = Specific volume of gas/vapor at the inlet of the pressure relief valve at the flowing pressure, m<sup>3</sup>/kg
- v<sub>1</sub> = specific volume of the two-phase fluid at the inlet of the valve at the flowing pressure, m<sup>3</sup>/kg

**Step Eight**

Select the proper pressure relief valve type based upon the conditions of the application. Emerson recommends the use of a safety relief valve for two-phase applications. As we learned in Chapter 3, the trim of a safety relief valve provides stable operation on either gas and/or liquid flow. Anderson Greenwood Crosby safety relief valves have certified nozzle coefficients for gas and liquid media that are used to calculate a two-phase coefficient of discharge in the next step of this procedure. It is also advisable that the safety relief valve selected be of a balanced design for these applications. It is oftentimes difficult to accurately predict the actual magnitude of built-up back pressure that will be developed by the flow of a flashing mixture of gas and liquid. You recall that a balanced direct spring valve or pilot operated valve will maintain lift and stability at higher built-up back pressures when compared to conventional pressure relief valves. See Table 6-8 for a summary of the recommended valve designs for use in two-phase flow applications.

**Step Nine**

Determine the coefficient of discharge for the selected valve.

$$K_{2\phi} = \alpha_1 K_G + (1 - \alpha_1) K_L$$

Where:

- K<sub>2φ</sub> = Two-phase coefficient of discharge
- α<sub>1</sub> = Void fraction of two phase mixture from step seven
- K<sub>G</sub> = Gas/vapor coefficient of discharge. See Chapter 8 Section IX
- K<sub>L</sub> = Liquid coefficient of discharge. See Chapter 8 Section IX

**Step Ten**

If built-up or superimposed back pressure is evident, calculate the back pressure correction factor.

$$K_{bw} = \alpha_1 K_b + (1 - \alpha_1) K_w$$

Where:

- $K_{bw}$  = Two-phase back pressure correction factor
- $\alpha_1$  = Void fraction of two-phase mixture from step seven
- $K_b$  = Back pressure correction factor for gas. See Chapter 8 Section II
- $K_w$  = Capacity correction factor for balanced relief valves due to back pressure. Use  $K_w$  equal to 1.0 pilot operated or conventional safety relief valves. See Figure 8-11 for direct acting safety relief valves.

- $K_c$  = Combination factor for installations with a rupture disc upstream of the valve. See Chapter 8 Section XI for flow certified factors. Use a 0.9 value for any rupture disc/pressure relief valve combination not listed in Chapter 8. Use a 1.0 value when a rupture disc is not installed
- $K_v$  = Capacity correction factor due to viscosity of the fluid at flowing conditions. For most applications viscosity will not affect the area calculation so  $K_v$  will be equal to 1.0. See Chapter 8 Section IV for more information
- $G$  = Required Mass flux from step five or six, kg/hr-mm<sup>2</sup>

**Step Eleven**

Calculate the minimum required discharge area.

$$A = \frac{W}{K_{2\phi} K_{bw} K_c K_v G}$$

Where:

- $A$  = Minimum required discharge area, square millimeters
- $W$  = Required mass flow rate of the mixture, kg/hr
- $K_{2\phi}$  = Two-phase coefficient of discharge from step nine
- $K_{bw}$  = Two-phase back pressure correction factor from step ten

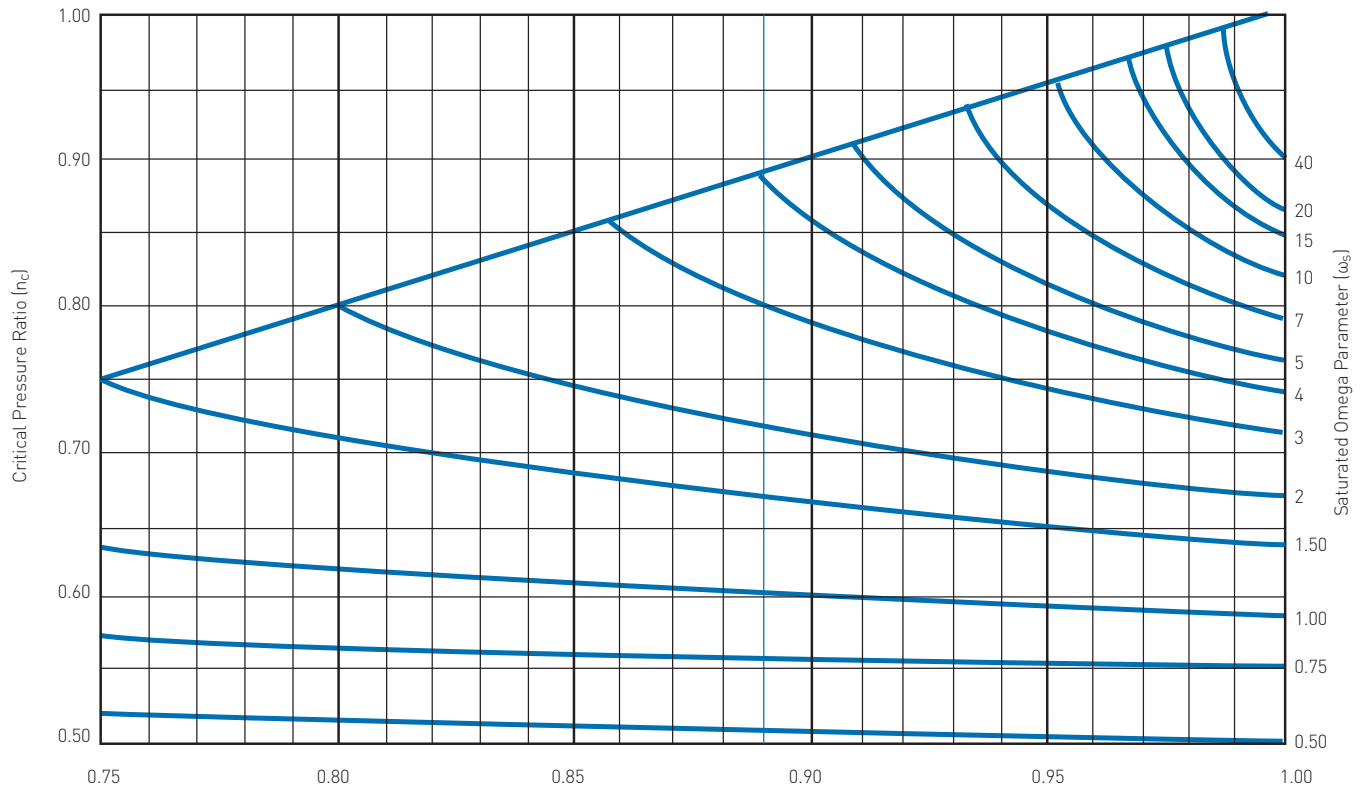


FIGURE 6-3  
 Saturated Pressure Ratio ( $h_s$ )  
 Critical Pressure Ratio for Low Subcooled Region Flashing Liquids



**API Standard 520 Part I (9th Edition) – Subcooled or Saturated all Liquid Flashes**

Where a 100% liquid process fluid flashes when the relief valve opens, the reduced Omega Method presented in API Standard 520 Part I can also be used to predict the behavior of the new mixture of liquid and its vapor created by the pressure drop across the valve nozzle. A liquid is called “subcooled” when it is at a temperature that is lower than its saturation temperature for a particular pressure. To use this procedure, no condensable vapor or non-condensable gas should be present in the liquid at the relief valve inlet. If these vapors or gases are in the mixture, use the two-phase flow procedure above. If the service fluid is saturated water, use the ASME Section VIII Appendix 11 method below.

**Step One**

Calculate the Omega parameter.

$$\omega_s = 9 \left( \frac{\rho_{l1}}{\rho_g} - 1 \right)$$

Where:

- $\omega_s$  = Saturated Omega parameter
- $\rho_g$  = Density of the mixture at 90% of the saturation or vapor pressure ( $P_s$ ) at the relieving temperature at the relief valve inlet. For multi-component liquids this represents the bubble point at the relieving temperature at the relief valve inlet, kg/m<sup>3</sup>
- $\rho_{l1}$  = Density of the liquid at the flowing pressure at the relief valve inlet, kg/m<sup>3</sup>

**Step Two**

The Omega parameter is now used to predict if the subcooled liquid will flash upstream of the bore diameter (minimum diameter) of the nozzle or at the nozzle bore diameter. This behavior is determined by the value of what is called the transition saturation pressure ratio which is calculated as follows.

$$\eta_{st} = \frac{2\omega_s}{1 + 2\omega_s}$$

Where:

- $\eta_{st}$  = Transition saturation pressure ratio
- $\omega_s$  = Saturated Omega parameter from step one

**Step Three**

Determine where the flash of the subcooled liquid occurs as follows:

If  $P_s \geq \eta_{st}P_1$  then the flash occurs upstream of the nozzle bore diameter of the PRV (also called the low subcooling region).

If  $P_s < \eta_{st}P_1$  then the flash occurs at the nozzle bore diameter of the PRV (also called the high subcooling region).

Where:

- $P_s$  = Saturation or vapor pressure at the relieving temperature at the relief valve inlet, bara
- $P_1$  = Flowing pressure, i.e. set pressure + allowable overpressure + atmospheric – inlet pressure piping losses, bara
- $\eta_{st}$  = Transition saturation pressure ratio from step two

**Step Four**

Determine the ratio of the saturation pressure to the set pressure.

$$\eta_s = \frac{P_s}{P_1}$$

Where:

- $P_s$  = Saturation or vapor pressure at the relieving temperature at the relief valve inlet, bara
- $P_1$  = Flowing pressure, i.e. set pressure + allowable overpressure + atmospheric – inlet piping losses, bara

*From the calculation in step three, if the flash occurs upstream of the nozzle bore diameter (low subcooling region) then move to step five.*

*From the calculation in step three, if the flash occurs at the nozzle bore diameter (high subcooling region) skip to step ten.*

**Step Five (low subcooled liquid region)**

Determine the critical pressure ratio ( $hc$ ) of the service fluid from Figure 6-3. Use the saturation pressure ratio ( $\eta_s$ ) from step four above and the saturated Omega ( $\omega_s$ ) value from step one above.

**Step Six (low subcooled liquid region)**

Calculate the critical pressure ( $P_c$ ) using the critical pressure ratio and determine whether the flow is critical or subcritical.

$$P_c = \eta_c P_1$$

Where:

- $P_c$  = Critical pressure, bara
- $\eta_c$  = Critical pressure ratio from step five
- $P_1$  = Flowing pressure, i.e. set pressure + allowable overpressure + atmospheric – inlet piping losses, bara

**If  $P_c \geq P_2$  then flow is critical (go to step seven).**

**If  $P_c < P_2$  then flow is subcritical (skip step seven and go to step eight).**

Where:

- $P_2$  = The total expected built-up and superimposed back pressure, bara

**Step Seven (low subcooled liquid region in critical flow)**

Calculate the required mass flux.

$$G = \frac{1.138 \sqrt{2(1-\eta_s) + 2[\omega_s \eta_s \ln\left(\frac{\eta_s}{\eta_c}\right) - (\omega_s - 1)(\eta_s - \eta_c)]} \sqrt{P_1 \rho_{l1}}}{\omega_s \left(\frac{\eta_s}{\eta_c} - 1\right) + 1}$$

Where:

- $G$  = Required mass flux, kg/hr mm<sup>2</sup>
- $\eta_s$  = Saturated pressure ratio from step four
- $\omega_s$  = Saturated Omega parameter from step one
- $\eta_c$  = Critical pressure ratio from step five
- $P_1$  = Flowing pressure, i.e. set pressure + allowable overpressure + atmospheric – inlet piping losses, bara
- $\rho_{l1}$  = Density of the liquid at the set pressure at the relief valve inlet, kg/m<sup>3</sup>

**Skip to step fourteen.**

**Step Eight (low subcooled liquid region in subcritical flow)**

Calculate the subcritical pressure ratio.

$$\eta_2 = \frac{P_2}{P_1}$$

Where:

- $P_2$  = The total expected built-up and superimposed back pressure, bara
- $P_1$  = Flowing pressure, i.e. set pressure + allowable overpressure + atmospheric – inlet piping losses, bara

**Step Nine (low subcooled liquid region in subcritical flow)**

Calculate the mass flux.

$$G = \frac{1.138 \sqrt{2(1-\eta_s) + 2[\omega_s \eta_s \ln\left(\frac{\eta_s}{\eta_2}\right) - (\omega_s - 1)(\eta_s - \eta_2)]} \sqrt{P_1 \rho_{l1}}}{\omega_s \left(\frac{\eta_s}{\eta_2} - 1\right) + 1}$$

Where:

- $G$  = Required mass flux, kg/hr-mm<sup>2</sup>
- $\eta_s$  = Saturated pressure ratio from step four
- $\omega_s$  = Saturated Omega parameter from step one
- $\eta_2$  = Subcritical pressure ratio from step eight
- $P_1$  = Flowing pressure, i.e. set pressure + allowable overpressure + atmospheric – inlet piping losses, bara
- $\rho_{l1}$  = Density of the liquid at the set pressure at the relief valve inlet, kg/m<sup>3</sup>

**Skip to step fourteen.**

**Step Ten (high subcooled liquid region)**

Determine if flow is critical or subcritical.

**If  $P_s \geq P_2$  then flow is critical (go to step eleven).**

**If  $P_s < P_2$  then flow is subcritical (skip step eleven and go to step twelve).**

Where:

- $P_s$  = Saturation or vapor pressure at the relieving temperature at the relief valve inlet, bara
- $P_2$  = The total expected built-up and superimposed back pressure, bara

**Step Eleven (high subcooled liquid region in critical flow)**

Calculate the mass flux.

$$G = 1.61 \sqrt{[\rho_{l1}(P_1 - P_s)]}$$

Where:

- $G$  = Required mass flux, kg/hr mm<sup>2</sup>
- $\rho_{l1}$  = Density of the liquid at the set pressure at the relief valve inlet, kg/m<sup>3</sup>
- $P_1$  = Flowing pressure, i.e. set pressure + allowable overpressure + atmospheric – inlet piping losses, bara
- $P_s$  = Saturation or vapor pressure at the relieving temperature at the relief valve inlet, bara

**Skip to step fourteen.**

**Step Twelve (high subcooled liquid region in subcritical flow)**

Calculate the mass flux.

$$G = 1.61 \sqrt{[\rho_{l1}(P_1 - P_2)]}$$

Where:

- $G$  = Required mass flux, lb/hr-mm<sup>2</sup>
- $\rho_{l1}$  = Density of the liquid at the flowing pressure at the relief valve inlet, kg/m<sup>3</sup>
- $P_1$  = Flowing pressure, i.e. set pressure + allowable overpressure + atmospheric – inlet piping losses, bara
- $P_2$  = The total expected built-up and superimposed back pressure, bara

**Step Thirteen**

Select the proper pressure relief valve type based upon the conditions of the application. Since the liquid is flashing to give a certain amount of two-phase flow through the pressure relief valve, Emerson recommends that a safety relief valve (operates in a stable fashion on either compressible or incompressible media) be selected. Since there will be flashing, Emerson recommends a balanced type pressure relief valve due to pressure variations that can occur in the valve body outlet. See Table 6-8 for a summary of recommended valve designs for use in two-phase applications.

**Step Fourteen**

Calculate the minimum required discharge area.

$$A = \frac{V_L \rho_{11}}{K K_v K_w G}$$

Where:

- A = Minimum required discharge area, square millimeters
- V<sub>L</sub> = Required relieving capacity, m<sup>3</sup>/hr at flowing temperature
- ρ<sub>11</sub> = Density of the liquid at the flowing pressure at the relief valve inlet, kg/m<sup>3</sup>
- K = Coefficient of discharge for liquid service. See Chapter 8 Section IX
- K<sub>v</sub> = Capacity correction factor due to viscosity of the fluid at flowing conditions. For most applications viscosity will not affect the area calculation so K<sub>v</sub> will be equal to 1.0. See Chapter 8 Section IV for more information
- K<sub>w</sub> = Capacity correction factor for balanced relief valves due to back pressure. Use K<sub>w</sub> equal to 1.0 for pilot operated and conventional safety relief valves. See Figure 8-11 for balanced direct acting safety relief valves
- G = Required mass flux from either steps 7, 9, 11, or 12, kg/hr-mm<sup>2</sup>

**ASME Section VIII, Appendix 11 – Flashing of Saturated Water**

When the process fluid at the pressure relief valve inlet is entirely saturated water one can refer to ASME Section VIII Appendix 11 to estimate the available mass flux for specific valve designs. Figure 6-4 is taken from Appendix 11 of the Code. The specific valve design requirements in order to use Figure 6-4 are:

- The ratio of the nozzle bore diameter (smallest cross section) to PRV inlet diameter must fall between 0.25 and 0.80.
- The actual (not rated) nozzle coefficient for gas/ vapor service must exceed 0.90.

**Step One**

Determine the available mass flux for a pressure relief valve that meets the above design requirements at the required set pressure from Figure 6-4. The curve in Figure 6-4 is based upon 10% overpressure. Use this available mass flux if sizing allows for higher overpressures as this will be a conservative value.

An example would be that a saturated water installation is requiring a prv to be set at 50 barg with a required capacity of 50,000 kg/hr of saturated water. The ordinate axis shows the available mass flux at 50 barg to be 70 kg/hr/mm<sup>2</sup>.

**Step Two**

Divide the required saturated water capacity by the available mass flux determined in step one to obtain the minimum required discharge area of the valve.

$$A = \frac{W}{G}$$

Where:

- W = Required relieving capacity of saturated water, kg/hr
  - G = Available PRV mass flux from step one
- So following with the example above, if the required saturated water capacity is 50,000 kg/hr, the required discharge or orifice area of the valve would be 50,000 (kg/hr) ÷ 70 (kg/hr-mm<sup>2</sup>) = 714.3 mm<sup>2</sup>.

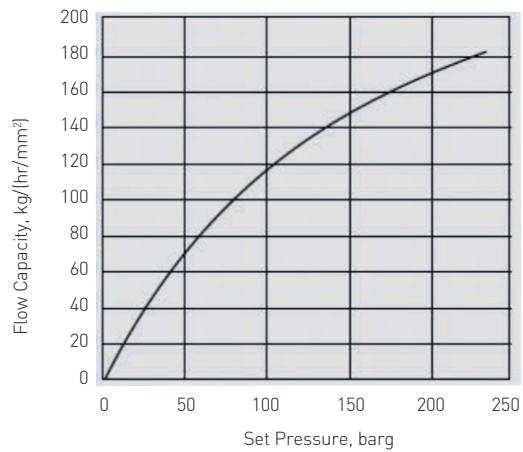


FIGURE 6-4  
 ASME Section VIII Appendix 11  
 Available Mass Flux - Saturated Water

**Step Three**

Select the proper pressure relief valve type based upon the conditions of the application and meet the design requirements required by the ASME Code that are listed above. Emerson recommends the use of a balanced type pressure relief valve due to pressure variations that can occur in the valve body outlet.

The following Crosby and Anderson Greenwood balanced valves meet the design requirements and may be considered:

- Balanced Direct Spring (JLT-JBS-E)
  - Modulating POPRV (Series 400/500/800) in 25F50, 40H75, 100P150, 150R200, 200T250 or any full bore (FB) orifice configuration
- Go to Chapter 8 and review the ASME (do not use the API tables) actual orifices for gas service listed in Tables 8-7, 8-8, 8-9, and Table 8-12 that are available for the valve types listed above. Therefore, to complete the example where we have a minimum orifice area requirement of 714.3 mm<sup>2</sup> we can look at Table 8-7 for a JLT-JBS-E configuration. This table will show a 50 mm inlet valve, with a "J" orifice designation, will have 937.4 mm<sup>2</sup> available. Provided the other requirements of the application meet this valve's specifications, this configuration would be an appropriate choice.

**VIII. NOISE LEVEL CALCULATIONS**

The following formula is used for calculating noise level of gases, vapors and steam as a result of the discharge of a pressure relief valve to atmosphere.

$$L_{30} = L + \left[ 10 \log_{10} \left( 1.1552 \frac{WkT}{M} \right) \right]$$

Where:

- $L_{30}$  = Sound level at 30 meters from the point of discharge in decibels
- $L$  = Sound level from Figure 6-5 in decibels
- $P_1$  = Pressure at the valve inlet during flow, bara. This is the set pressure (barg) + overpressure (barg) + atmospheric pressure (bara)
- $P_2$  = Pressure at the valve outlet during flow, psia [bara]. This is back pressure (barg) + atmospheric pressure (bara)
- $k$  = Specific heat ratio. See Chapter 8 Section VII
- $M$  = Molecular weight of the gas or vapor. See Chapter 8 Section VII
- $T$  = Absolute temperature of the fluid at the valve inlet, degrees Kelvin ( $^{\circ}\text{C} + 273$ )
- $W$  = Maximum relieving capacity, kg/hr

The noise level should be calculated using the maximum or total flow through the pressure relief valve at the specified overpressure. This value can be calculated by using the sizing formulas on page 6.4 for weight flow and solving for "W". Use the "actual" area and "actual" coefficient of discharge for the specific valve from tables in Chapter 8 Section IX. The actual coefficient is the "rated coefficient" divided by 0.90. When the noise level is required at a distance of other than 30 meters, the following equation shall be used:

$$L_p = L_{30} - 20 \log_{10} \left( \frac{r}{30} \right)$$

Where:

- $L_p$  = Sound level at a distance, r, from the point of discharge in decibels
- $r$  = Distance from the point of discharge, meters

Table 6-9 lists some relative noise intensity levels

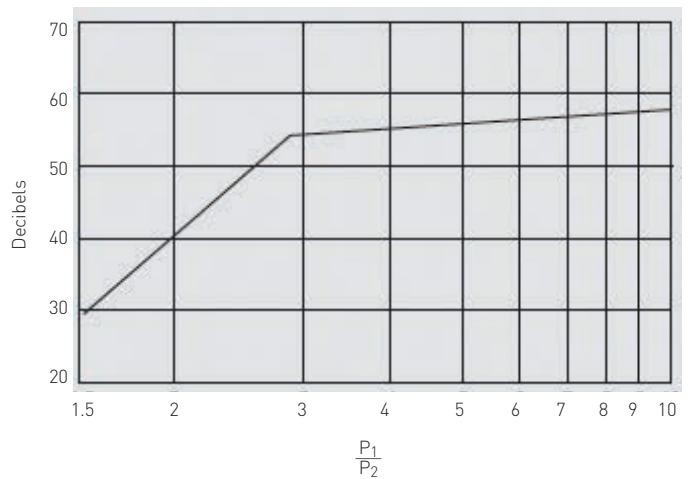


FIGURE 6-5  
 Sound Pressure Level at 30 meters from Point of Discharge

**TABLE 6-9 – NOISE INTENSITY (at 30 meters from the discharge)**

Relative Noise Levels		
130	Decibels	Jet Aircraft on Takeoff
120	Decibels	Threshold of Feeling
110	Decibels	Elevated Train
100	Decibels	Loud Highway
90	Decibels	Loud Truck
80	Decibels	Plant Site
70	Decibels	Vacuum cleaner
60	Decibels	Conversation
50	Decibels	Offices

**IX. REACTION FORCES**

---

The discharge from a pressure relief valve exerts a reaction force on the valve, vessel and/or piping as a result of the flowing fluid. Determination of outlet reaction forces and the design of an appropriate support system is the responsibility of the designer of the vessel and/or piping. The following is published as technical advice or assistance.

**Reaction Force for Open Discharge – Gas Service**

The following formulas are used for the calculation of reaction forces for a pressure relief valve discharging gas or vapor directly to atmosphere. It is assumed that critical flow of the gas or vapor is obtained at the discharge outlet. Under conditions of subcritical flow the reaction forces will be less than that calculated. The equations are based on API Recommended Practice 520 Part 2.

$$F = 0.03583 \sqrt{\frac{kT_i}{(k+1)M}} + 0.10A_o [P_2 - P_A]$$

Where:

- F = Reaction force at the point of discharge to atmosphere, N. See Figure 6-6
- A<sub>o</sub> = Area at discharge, square millimeters
- k = Specific heat ratio at the outlet conditions
- M = Molecular weight of the gas or vapor obtained from standard tables or see Chapter 8 Section II
- P<sub>2</sub> = Static pressure at discharge, bara calculated below:

$$P_2 = 0.25329 \frac{W}{A_o} \sqrt{\frac{T_o}{kM}}$$

- P<sub>A</sub> = Ambient pressure, bara
- T<sub>i</sub> = Absolute temperature of the fluid at the valve inlet, degrees Kelvin [°C + 273]
- T<sub>o</sub> = Absolute temperature of the fluid at the discharge, degrees Kelvin [°C + 273]
- W = Actual relieving capacity, kg/hr. This value may be calculated by using the sizing formula on page 6.4 for weight flow. Use the ASME actual area and the rated coefficient divided by 0.9 to get the actual capacity of the valve.

The above equations account for static thrust force only and do not consider a force multiplier required for rapid application of the reactive thrust force. ASME B31.1 Non-Mandatory Appendix II includes a method of analysis for dynamic load factors. Force multipliers up to 2 times F are possible. This is only necessary for open discharge with rapid opening valves (i.e. ASME Section I safety valves).

**Reaction Force for Open Discharge – Steam Service**

The following formula is used for the calculation of reaction forces for a pressure relief valve discharging steam directly to atmosphere. The equations are based on equations in ASME B31.1 Non-mandatory Appendix II.

$$F = 0.0046409 W (\sqrt{h_o - 1914.3}) + 0.10 A_o [P_2 - P_A]$$

Where:

- F = Reaction force at the point of discharge to atmosphere, N
- $h_o$  = Stagnation enthalpy at the valve inlet, kJ/kg
- $A_o$  = Area at discharge, square millimeters
- $P_2$  = Static pressure at discharge, bara
- $P_A$  = Ambient pressure, bara
- W = Actual relieving capacity, kg/hr. This value may be calculated by using the sizing formula on page 6.6. Use the ASME actual area and the rated coefficient divided by 0.9 to get the actual capacity of the valve.

The above equations account for static thrust force only and do not consider a force multiplier required for rapid application of the reactive thrust force. ASME B31.1

Non-Mandatory Appendix II includes a method of analysis for dynamic load factors. Force multipliers up to 2 times F are possible. This is only necessary for open discharge with rapid opening valves (i.e. ASME Section I safety valves).

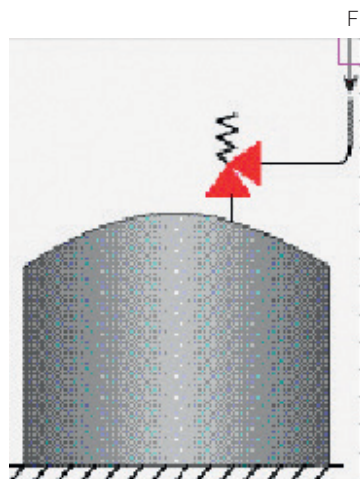


FIGURE 6-6  
 Open Discharge Reaction Force

**Reaction Force for Open Discharge – Liquid Service**

The following formula is used for the calculation of reaction forces for a pressure relief valve discharging liquid directly to atmosphere. The equations are based on fluid momentum. Liquid flow is assumed to be non-flashing.

$$F = \frac{(0.07689) W^2}{\rho A_o}$$

Where:

- F = Reaction force at the point of discharge to atmosphere, N
- $A_o$  = Area at discharge, square millimeters
- W = Actual relieving capacity, kg/hr. This value may be calculated by using the sizing formula on page 6.11. Use the ASME actual area and the rated coefficient divided by 0.9 to get the actual capacity of the valve.
- $\rho$  = Density of the fluid, kg/m<sup>3</sup>

**Reaction Force for Open Discharge – Two-Phase Flow**

The following formula is found in API 520 Part 2. This formula assumes the two-phase flow is in a homogeneous condition (well mixed and both phases flowing at the same velocity).

$$F = \frac{W^2}{12.96 A_o} \left[ \frac{\chi}{\rho_g} + \frac{(1 - \chi)}{\rho_l} \right] + 10 A_o (P_E - P_A)$$

- F = Reaction force at the point of discharge to atmosphere, N  
 See Figure 6-6.
- W = Actual relieving capacity, kg/hr
- $A_o$  = Area at discharge outlet to atmosphere, square millimeters
- X = Mass fraction of gas/vapor portion  $\left( \frac{W_G}{W} \right)$
- $W_G$  = Actual relieving capacity of gas, kg/hr
- $\rho_g$  = Vapor density at exit conditions, kg/m<sup>3</sup>
- $\rho_l$  = Liquid density at exit conditions, kg/m<sup>3</sup>
- $P_E$  = Pressure at pipe exit, bara
- $P_A$  = Ambient pressure, bara

**THE FOLLOWING DATA WITH CHARTS AND TABLES ARE INCLUDED IN THIS CHAPTER**

---

I. Compressibility Factor, Z .....	7.3
II. Capacity Correction Factor for Back Pressure, $K_b$ .....	7.4
III. Capacity Correction Factor for High Pressure Steam, $K_n$ .....	7.31
IV. Capacity Correction Factor for Viscosity, $K_v$ .....	7.31
V. Capacity Correction Factor for Superheat, $K_{sh}$ .....	7.33
VI. Ratio of Specific Heats, k, and Coefficient, C .....	7.35
VII. Typical Fluid Properties.....	7.36
VIII. Steam Saturation Pressure/Temperature .....	7.40
IX. Orifice Area and Coefficient of Discharge for Anderson Greenwood and Crosby Pressure Relief Valve .....	7.41
X. Equivalent and Conversion Factors .....	7.48
XI. Capacity Correction Factor for Rupture Disc/Pressure Relief Device Combination, $K_c$ .....	7.54

PRESSURE RELIEF VALVE ENGINEERING HANDBOOK  
 CHAPTER 7 - ENGINEERING SUPPORT INFORMATION - USCS UNITS (UNITED STATES CUSTOMARY SYSTEM)

**THE FOLLOWING FIGURES ARE INCLUDED IN THIS CHAPTER**

Figure 7-1	Nelson Obert Compressibility Chart .....	7.3
Figure 7-2	Effect of Built-up Back Pressure on Conventional PRV .....	7.4
Figure 7-3	Relationship of $P_2$ and $P_2'$ .....	7.6
Figure 7-4	Valve Selection Recommendations for Built-up Back Pressure Installations.....	7.7
Figure 7-5	Valve Selection Recommendations for Constant Superimposed Back Pressure Installations (no built-up back pressure).....	7.8
Figure 7-6	Valve Selection Recommendations for Variable Superimposed Back Pressure Installations .....	7.9
Figure 7-7	Valve Selection Recommendations for Constant Superimposed Back Pressure Installations (with built-up back pressure).....	7.10
Figure 7-8	Crosby Series JOS-E Conventional Direct Spring PRV Back Pressure Correction Factor ( $K_b$ ) Gas/Steam Service.....	7.11
Figure 7-9	Crosby Series JLT-JOS-E Conventional Direct Spring PRV Back Pressure Correction Factor ( $K_b$ ) Gas/Steam Service .....	7.12
Figure 7-10	Crosby Series JBS-E/JLT-JBS-E Balanced Bellows Direct Spring PRV Back Pressure Correction Factor ( $K_b$ ) Gas/Steam Service .....	7.13
Figure 7-11	Crosby Series JLT-JBS-E Balanced Bellows Direct Spring PRV Back Pressure Correction Factor ( $K_w$ ) Liquid Service .....	7.14
Figure 7-12	Crosby Series 800 Conventional Direct Spring PRV Back Pressure Correction Factor ( $K_b$ ) Gas/Steam Service .....	7.15
Figure 7-13	Crosby Series 900 Conventional Direct Spring PRV Back Pressure Correction Factor ( $K_b$ ) Gas/Steam Service .....	7.16
Figure 7-14	Crosby Series BP Back Pressure Correction Factor ( $K_w$ ) Liquid Service .....	7.17
Figure 7-15	Crosby Series BP Back Pressure Correction Factor ( $K_b$ ) Gas Service .....	7.18
Figure 7-16	Anderson Greenwood Series 61 Conventional Direct Spring PRV Back Pressure Correction Factor ( $K_b$ ) Gas Service .....	7.19
Figure 7-17	Anderson Greenwood Series 63B [-5 Orifice Only] Conventional Direct Spring PRV Back Pressure Correction Factor ( $K_b$ ) Gas.....	7.20
Figure 7-18	Anderson Greenwood Series 63B [-7 Orifice Only] Conventional Direct Spring PRV Back Pressure Correction Factor ( $K_b$ ) Gas.....	7.21
Figure 7-19	Anderson Greenwood Series 81P Back Pressure Correction Factor ( $K_w$ ) Liquid Service .....	7.22
Figure 7-20	Anderson Greenwood Series 81/83/86 Conventional Direct Spring PRV Back Pressure Correction Factor ( $K_b$ ) Gas/Steam .....	7.23
Figure 7-21	Anderson Greenwood Series 81P [-8 Orifice Only] Balanced Piston Direct Spring PRV Back Pressure Correction Factor ( $K_b$ ) Gas .....	7.24
Figure 7-22	Anderson Greenwood Series 90/9000 POPRV Back Pressure Correction Factor ( $K_b$ ) Gas Service .....	7.25
Figure 7-23	Anderson Greenwood Series 40 Pilot Operated PRV Back Pressure Correction Factor ( $K_b$ ) Gas/Steam Service .....	7.26
Figure 7-24	Anderson Greenwood Series 50 Pilot Operated PRV Back Pressure Correction Factor ( $K_b$ ) Gas/Steam Service .....	7.27
Figure 7-25	Anderson Greenwood Series 60 Pilot Operated PRV Back Pressure Correction Factor ( $K_b$ ) Gas/Steam Service .....	7.28
Figure 7-26	Anderson Greenwood Series LCP Pilot Operated PRV Back Pressure Correction Factor ( $K_b$ ) Gas Service .....	7.29
Figure 7-27	Anderson Greenwood Series 727 Pilot Operated PRV Back Pressure Correction Factor ( $K_b$ ) Gas/Steam Service .....	7.30
Figure 7-28	Correction Factor for High Pressure Steam ( $K_n$ ).....	7.31
Figure 7-29	Viscosity Correction Factor ( $K_v$ ).....	7.32
Figure 7-30	Ratio of Specific Heats, $k$ , and Coefficient, $C$ .....	7.35

**THE FOLLOWING TABLES ARE INCLUDED IN THIS CHAPTER**

Table 7-1	Superheat Correction Factor.....	7.33
Table 7-2	Gas Constant.....	7.35
Table 7-3	Physical Properties for Selected Gases.....	7.36
Table 7-4	Physical Properties for Selected Liquids.....	7.38
Table 7-5	Saturated Steam Pressure Table .....	7.40
Table 7-6	JOS-E/JBS-E/JLT-E Full Nozzle Direct Acting Spring Valves (API Effective Orifice Areas/API Effective Coefficient of Discharge).....	7.42
Table 7-7	JOS-E/JBS-E/JLT-E Full Nozzle Direct Acting Spring Valves (ASME Areas/ASME Coefficient of Discharge).....	7.42
Table 7-8	OMNI 800/900/BP Portable Direct Acting Spring Valves Orifice Areas/Coefficient of Discharge.....	7.43
Table 7-9	Series 60 and Series 80 Portable Direct Acting Spring Valves Orifice Areas/API Effective Coefficient of Discharge .....	7.43
Table 7-10	H Series Direct Acting Spring Safety Valves Orifice Areas/Coefficient of Discharge.....	7.44
Table 7-11	High Pressure Pilot Operated Valves (API Effective Orifice Areas/Coefficient of Discharge) .....	7.44
Table 7-12	High Pressure Pilot Operated Valves (ASME Areas/ASME Coefficient of Discharge) .....	7.45
Table 7-13	Low Pressure Pilot Operated Valves (Set Pressure $\geq 15$ psig) Orifice Areas/Coefficient of Discharge .....	7.46
Table 7-14	Low Pressure Pilot Operated Valves (Set Pressure $< 15$ psig) Orifice Areas/Coefficient of Discharge .....	7.46
Table 7-15	Low Pressure Pilot Operated Valves Orifice Areas/Coefficient of Discharge .....	7.47
Table 7-16	JB-TD Direct Acting Spring Valves Orifice Areas/Coefficient of Discharge .....	7.47
Table 7-17	Equivalents and Conversion Factors.....	7.48
Table 7-18	Pressure Conversions .....	7.50
Table 7-19	Gas Flow Conversions .....	7.51
Table 7-20	Liquid Flow Conversions .....	7.52
Table 7-21	Viscosity Conversion .....	7.53
Table 7-22	Capacity Correction Factor for Rupture Disc/PRV Combination.....	7.55



**I. COMPRESSIBILITY FACTOR, Z**

The gas and vapor formulas of this handbook are based on perfect gas laws. Many real gases and vapors, however, deviate from a perfect gas. The compressibility factor Z is used to compensate for the deviations of real gases from the ideal gas.

The compressibility factor may be determined from thermodynamic charts such as the Nelson Obert compressibility chart shown in Figure 7-1.

Z is a function of the reduced pressure and the reduced temperature of the gas. The reduced temperature is equal to the ratio of the actual absolute inlet gas temperature to the absolute critical temperature of the gas.

$$T_r = \frac{T}{T_c}$$

Where:

$T_r$  = Reduced temperature

T = Inlet fluid temperature, °F + 460

$T_c$  = Critical temperature, °F + 460

The reduced pressure is equal to the ratio of the actual absolute inlet pressure to the critical pressure of the gas.

$$P_r = \frac{P}{P_c}$$

Where:

$P_r$  = Reduced pressure

P = Relieving pressure

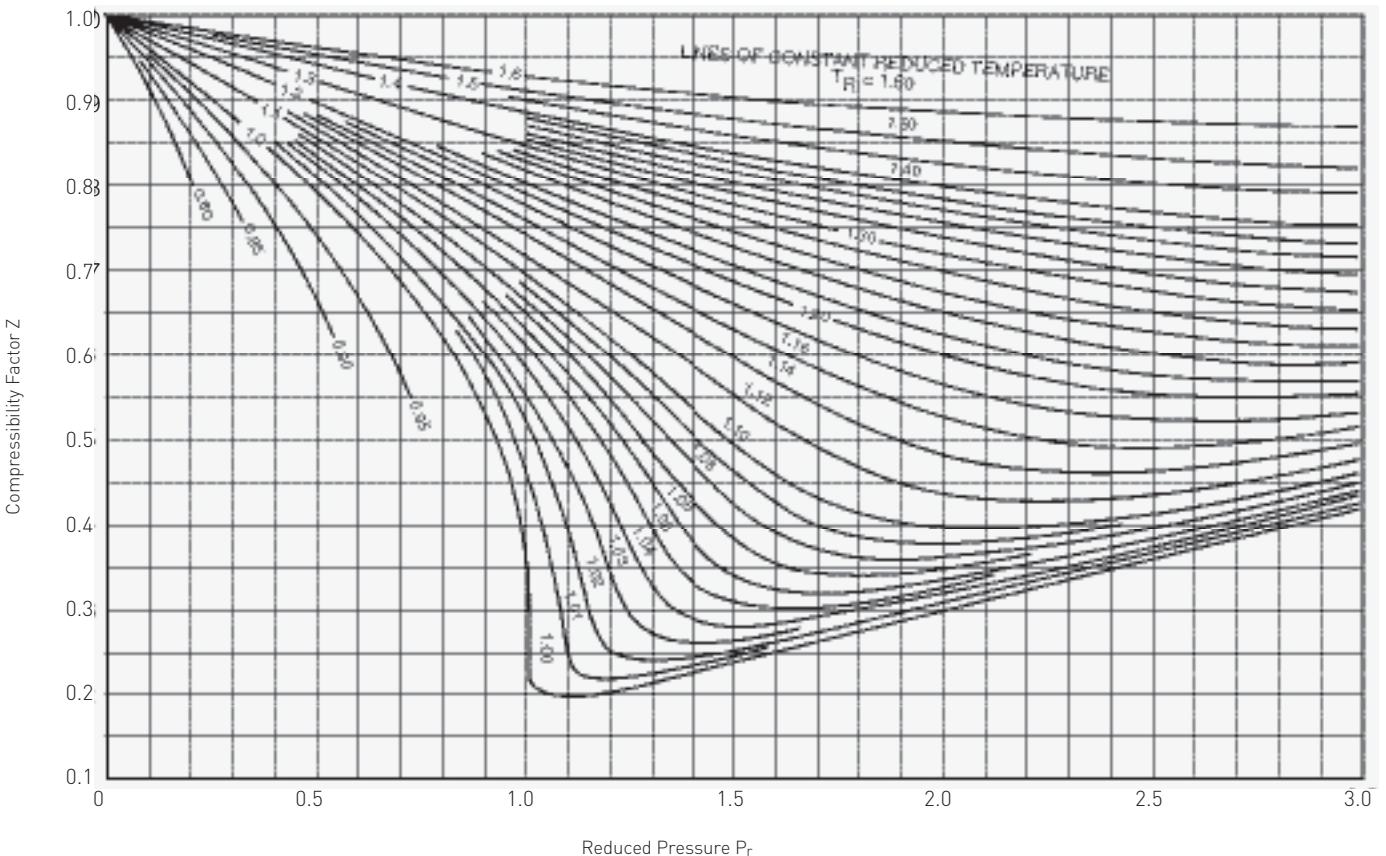
(set pressure + overpressure + atmospheric pressure), psia

$P_c$  = Critical pressure, psia

Enter the chart at the value of reduced pressure, move vertically to the appropriate line of constant reduced temperature.

From this point, move horizontally to the left to read the value of Z. In the event the compressibility factor for a gas or vapor cannot be determined, a conservative value of Z = 1 is commonly used.

FIGURE 7-1 - Nelson Obert Compressibility Chart



**II. CAPACITY CORRECTION FACTORS FOR BACK PRESSURE,  $K_b$**

**General**

Back pressure can exist in any location that is downstream from the actual discharge area of a pressure relief valve. This pressure can be due to piping causing resistance to flow, pressures from other equipment discharging to a common header system, or from a flashing fluid being relieved. Without proper consideration of the effects of back pressure, the PRV may experience one, some or all of the following.

- Change in set pressure
- Change in reseating pressure
- Lift instability
- Decrease in actual relieving capacity

This particular section of the engineering handbook will deal with the sizing capacity correction factors that need to be considered for various types of pressure relief valves.

**Built-up Back Pressure**

As you recall from Chapter Three, a pressure relief valve whose outlet is discharging to atmosphere or into a piping system will experience built-up back pressure. This type of back pressure is only evident after the valve has opened and is relieving, it does not affect the set pressure of the PRV.

For a conventional PRV, the change in the force balance of the disc holder due to back pressure will hinder the upward lifting force. The conservative rule of thumb is that if the built-up back pressure exceeds the available overpressure to lift the valve, then a conventional valve should not be used because the lifting force may not be sufficient for the valve to operate in a stable fashion. Figure 7-2 illustrates the effect built-up back pressure has upon a conventional PRV design where there is 10% overpressure available. If there was a fire case contingency where there may be 21% overpressure, then a curve similar to Figure 7-2 would show full capacity up to 21% built-up back pressure.

An exception to this conventional valve built-up back pressure and overpressure relationship is the Crosby brand H series product that is normally provided for ASME Section I applications. The H series valve is normally provided with the open spring bonnet design. This opening to atmosphere dramatically decreases the built-up back pressure amount that acts down on the disc holder. For this valve design, when the H series valve is in lift with 3% overpressure, the calculated built-up back pressure at the outlet flange of the valve can be up to a maximum of 27.5% of the set pressure.

There is no capacity correction factor in either gas/vapor or liquid applications for a suitable conventional prv where the valve is exposed to built-up back pressure which is less than the available overpressure. In other words, the  $K_b$  or  $K_w$  will be 1.0.

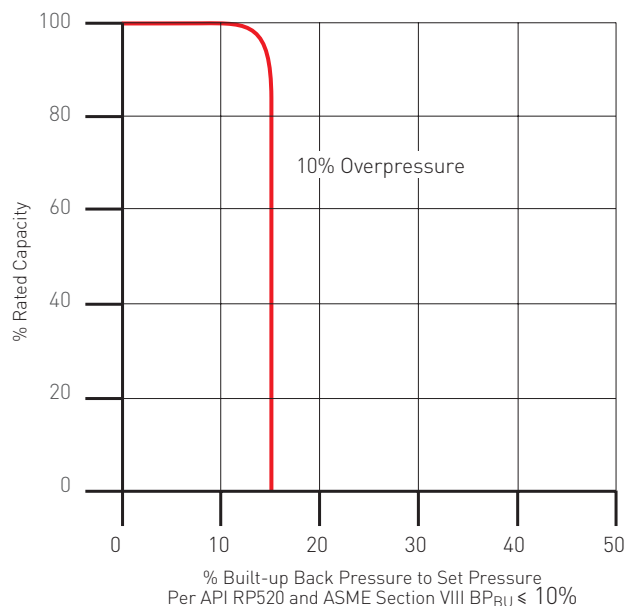
When a balanced direct spring or pilot operated PRV is open and flowing against a built-up back pressure, the lift of the device should be stable if properly designed. The built-up back pressure can exceed the available overpressure for these devices. However, the capacity that the PRV is able to deliver may be less than expected due to a reduced, but stable, lift and/or a compressible fluid flow transitions from critical to subcritical conditions.

The calculation of the magnitude of the built-up back pressure, and the subsequent design of the outlet piping for a new installation, is oftentimes an iterative process.

- The PRV is initially sized with the assumption of a maximum built-up back pressure. For instance, in an application that may require the process fluid exhaust to be routed via a simple tail pipe discharge to atmosphere, the sizing for the PRV may assume a built-up back pressure to be 10% of the flowing pressure. This assumption would allow the use of a conventional direct spring PRV.

- The PRV required minimum orifice is then selected based upon a  $K_b = 1.0$ .
- Once the PRV is selected, the engineer should perform a pressure drop calculation for the proposed size and style of discharge pipe. In the example above, the pressure drop through the tailpipe should be determined.
- The API Standard 521 will guide the engineer to use the rated capacity for some types of direct spring operated PRV (recall that safety valves obtain substantial lift at the set pressure) or the required capacity for a modulating action pilot operated PRV to calculate the pressure loss in the discharge piping. This will provide the magnitude of built-up back pressure at the outlet flange of the PRV.
- If this calculated built-up back pressure exceeds 10% then, for this example, the tailpipe may need to be redesigned to provide less resistance to flow. Perhaps enlarging or straightening this fitting is possible to reduce the built-up back pressure.
- If the outlet piping cannot be changed, then a balanced or pilot operated PRV may need to be considered and the iterative process begins again. We will discuss the correction factors for balanced and pilot operated PRVs below.

FIGURE 7-2  
 Effect of Built-up Back Pressure on Conventional PRV



**Superimposed Back Pressure**

When the outlet of a PRV is connected to a closed discharge system, it may not only be exposed to built-up back pressure but may also see superimposed back pressure. The superimposed back pressure is evident on the downstream side of the PRV before the valve has opened. This is very common in process plant environments where effluents are captured or thermally oxidized via common header systems. This superimposed back pressure may be a constant value but it could vary in these types of installations.

A conventional, unbalanced PRV can be considered if the superimposed back pressure is a constant value. As we learned in Chapter Three, one can set the conventional PRV with a bias on the test bench to account for this constant superimposed back pressure. All unbalanced Crosby and Anderson Greenwood brand PRVs have a force balance that will cause a unit-for-unit increase in the in situ opening pressure when superimposed back pressure is present. In other words, if there is 50 psig of superimposed back pressure the unbalanced valve will open 50 psig higher than the opening pressure allowed by just the spring compression. For this example, the spring compression can be set 50 psig lower to compensate for the constant superimposed back pressure. As you recall, this bias is one element of the cold differential set pressure (CDTP) setting.

A balanced direct acting or pilot operated PRV does not need any test bench correction for superimposed back pressure. Therefore, when the superimposed back pressure is variable it is recommended to use these particular valve designs.

The calculation of superimposed back pressure is performed by examining the entire pressure relief disposal system and making determinations regarding whether or not other devices attached to the system may be operating at the time the PRV is to open and then relieve. These effluent flows are then used with the disposal system piping geometry to determine what the superimposed back pressure may be at the outlet flange of the PRV. The maximum superimposed back pressure should be listed on the PRV data sheet.

**Compressible Fluid Back Pressure Correction Charts**

There are several figures in this chapter that show back pressure correction factors for various series of Emerson products used in compressible media service. For example, Figure 7-8 shows the  $K_b$  factor for the Crosby JOS-E conventional PRV and we will use this chart to help explain why these back pressure capacity corrections are needed.

Properly setting a conventional PRV, such as the Crosby JOS-E, with a CDTP will provide an adequate lift to meet its certified capacity. This is contingent upon any built-up back pressure that is developed will not exceed the available overpressure at the set pressure. In gas service, there may be a capacity correction factor required for conventional PRVs. The  $K_b$  factor in this case is a result of the flow becoming what is called subcritical at the discharge area of the PRV.

When the flow is critical at the discharge area of the PRV it can also be called "choked flow." This means that even if the back pressure is reduced there can be no more flow capacity provided through the PRV. Once the flow becomes subcritical then any change in back pressure will change the capacity.

The transition from critical to subcritical flow is based upon the critical pressure of the gas service. This critical pressure is calculated as follows:

$$P_{critical} = P_1 \left[ \frac{2}{K+1} \right]^{\frac{k}{k-1}}$$

Where:

$P_1$  =  $P_{set}$  + Overpressure + atmospheric - inlet pressure piping loss, psia

$k$  = ratio of specific heat

If the sum of the built-up back pressure and superimposed back pressure exceed this critical pressure then the capacity will be reduced. As an example, let us consider the gas as air with a ratio of specific heats equal to 1.4. Let us assume that the absolute relieving pressure ( $P_1$ ) is 100 psia. After performing the calculation above, the critical pressure will be equal to 52.8 psia. This means that capacity will be reduced when the total back pressure at the outlet of the discharge area is greater than 52.8 psia.

As mentioned above, the calculation of the superimposed and built-up back pressure gives a value for these pressures at the PRV outlet flange. The capacity of the PRV is determined by the conditions at the location of the actual discharge area. For the Crosby JOS-E series valve this is the nozzle outlet. If you look at Figure 7-3, the total calculated superimposed and built-up back pressure is denoted by  $P_2$  while it is the  $P_2'$  pressure at the nozzle outlet that determines whether the flow is critical or subcritical. The outlet of the body of the JOS-E creates additional built-up back pressure that is not accounted for in the total (built-up plus superimposed) back pressure calculations at the outlet flange, making the value of  $P_2'$  higher than  $P_2$ . Therefore, using Figure 7-8 and our previous example where the critical pressure is 52.8 psia, you will note in the figure that when the calculated total back pressure is approximately 20% of the flowing pressure we begin to adjust the capacity with the  $K_b$  value. This is well below the expected 0.528 critical pressure ratio or 52.8 psia critical pressure. This is due to the  $P_2'$  and  $P_2$  relationship. The  $P_2'$  is actually above the critical pressure when the calculated total back pressure at the outlet flange ( $P_2$ ) is reaching 20% of the flowing pressure. This same  $P_2'$  and  $P_2$  relationship holds for other valve designs such as the Crosby balanced bellows and most of the Anderson Greenwood pilot operated PRVs. This relationship is also a contributor to the liquid  $K_w$  correction factors for various valve designs. Use the following flow charts (Figures 7-4 through 7-7) to assist with selecting an appropriate Emerson model recommendation and back pressure capacity correction factor.

FIGURE 7-3  
Relationship of  $P_2'$  and  $P_2$

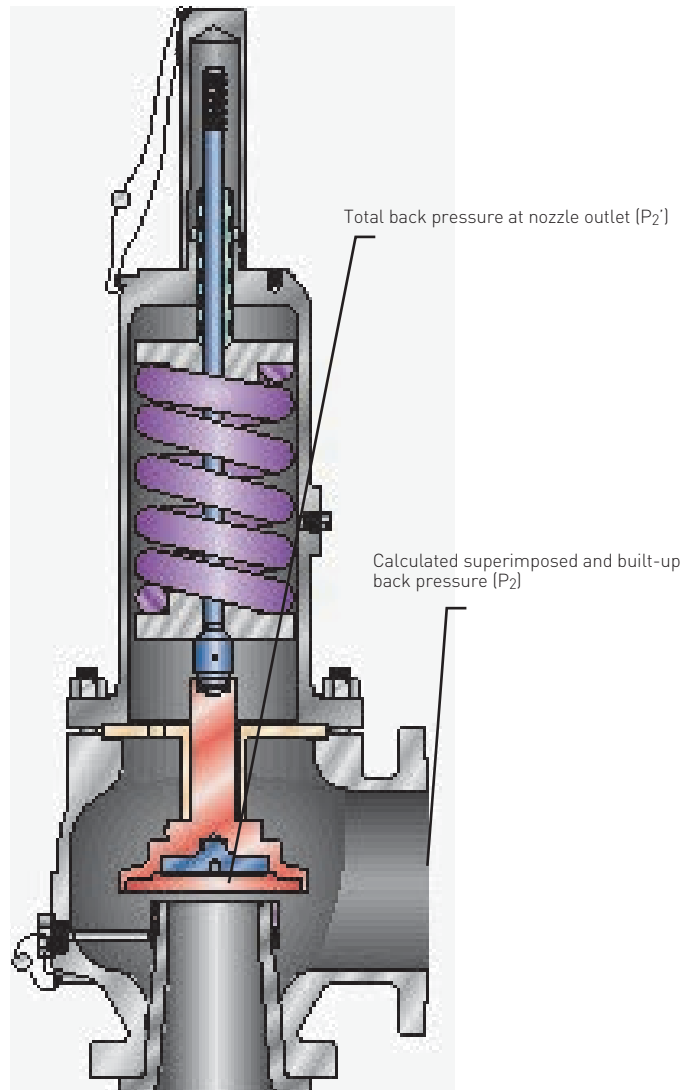


FIGURE 7-4  
 Valve Selection Recommendations for Built-up Back Pressure Installations (No Superimposed Back Pressure)

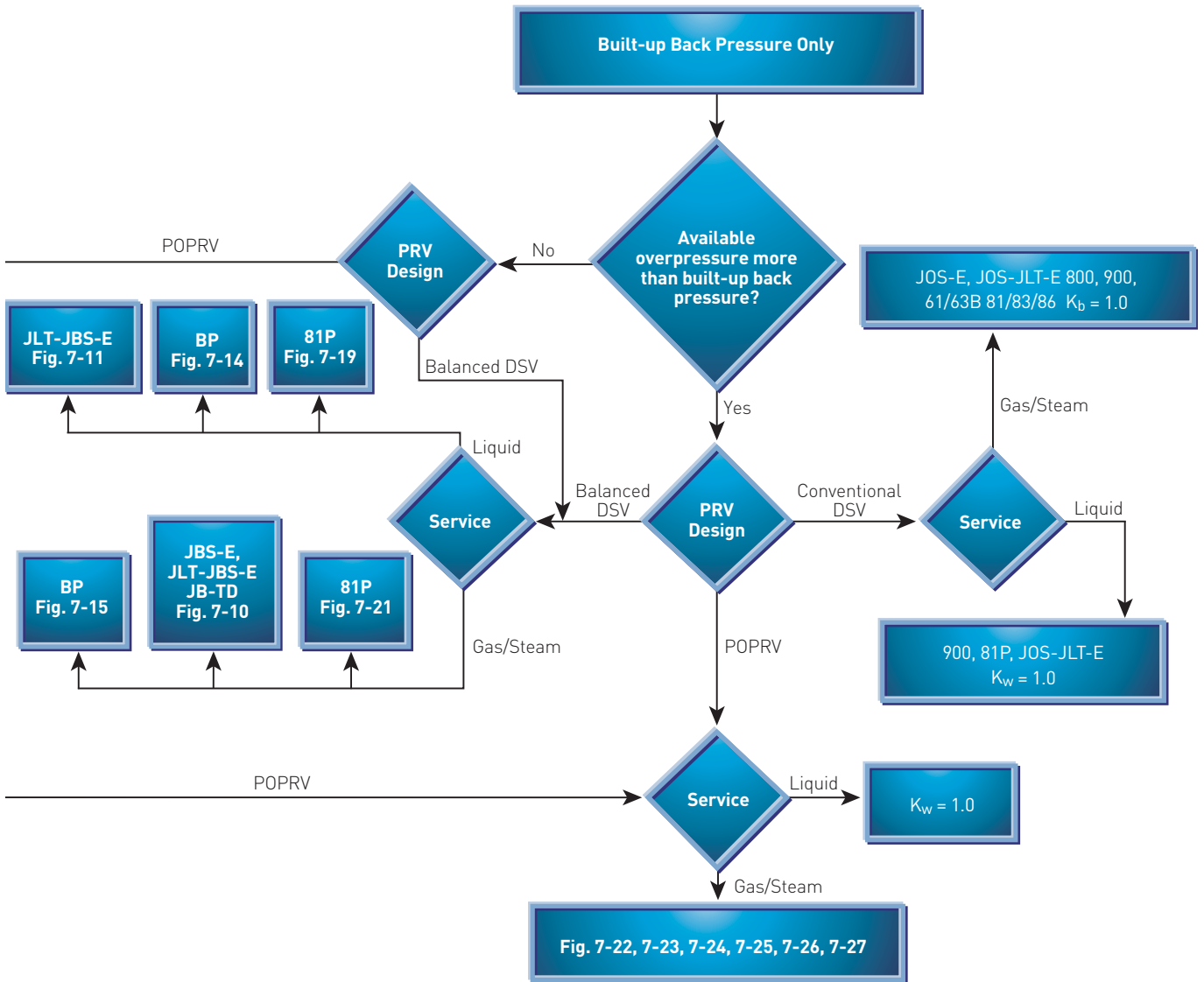


FIGURE 7-5  
 Valve Selection Recommendations for Constant Superimposed Back Pressure Installations (No Built-up Back Pressure)

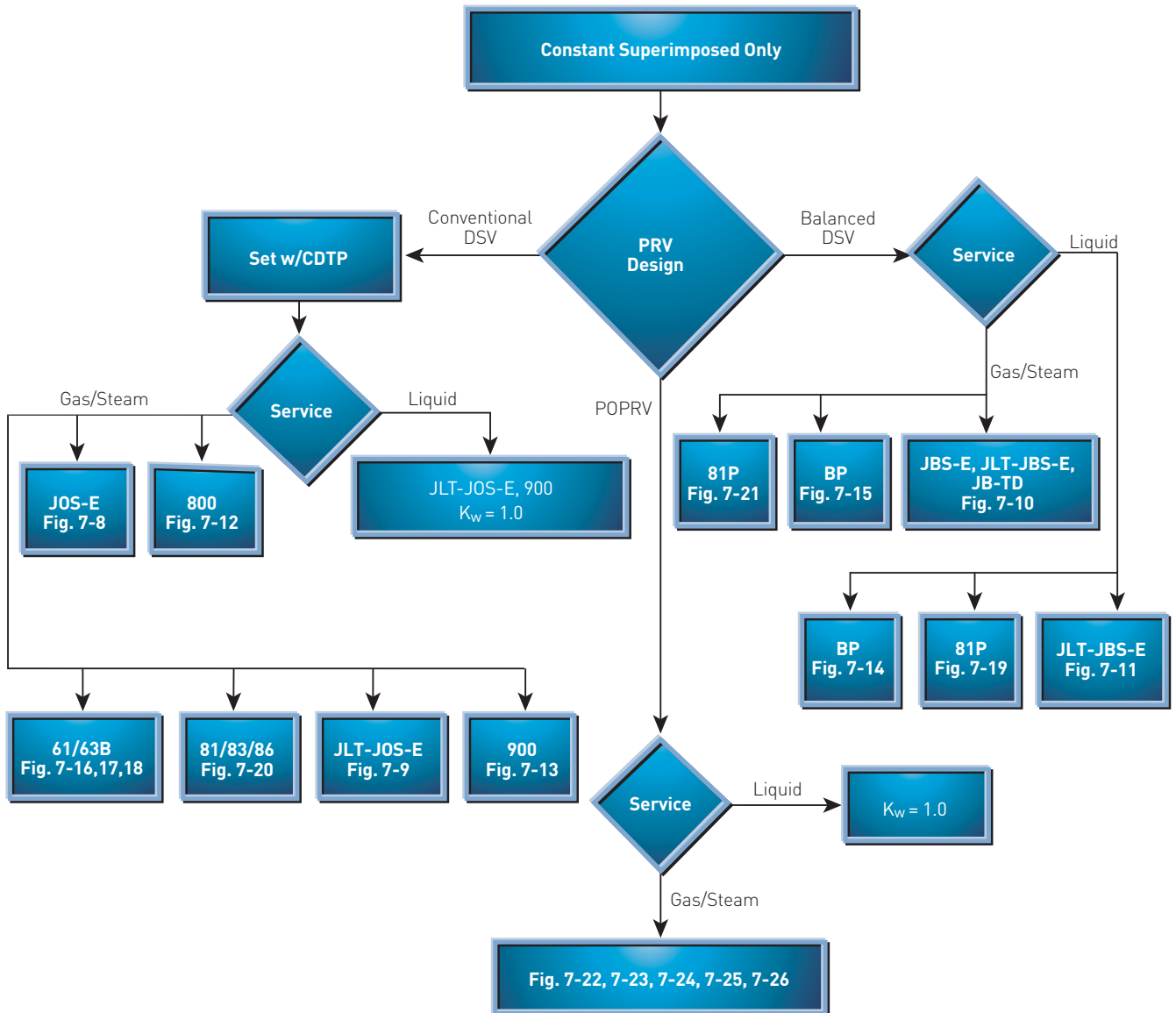


FIGURE 7-6  
 Valve Selection Recommendations for Variable Superimposed Back Pressure Installations

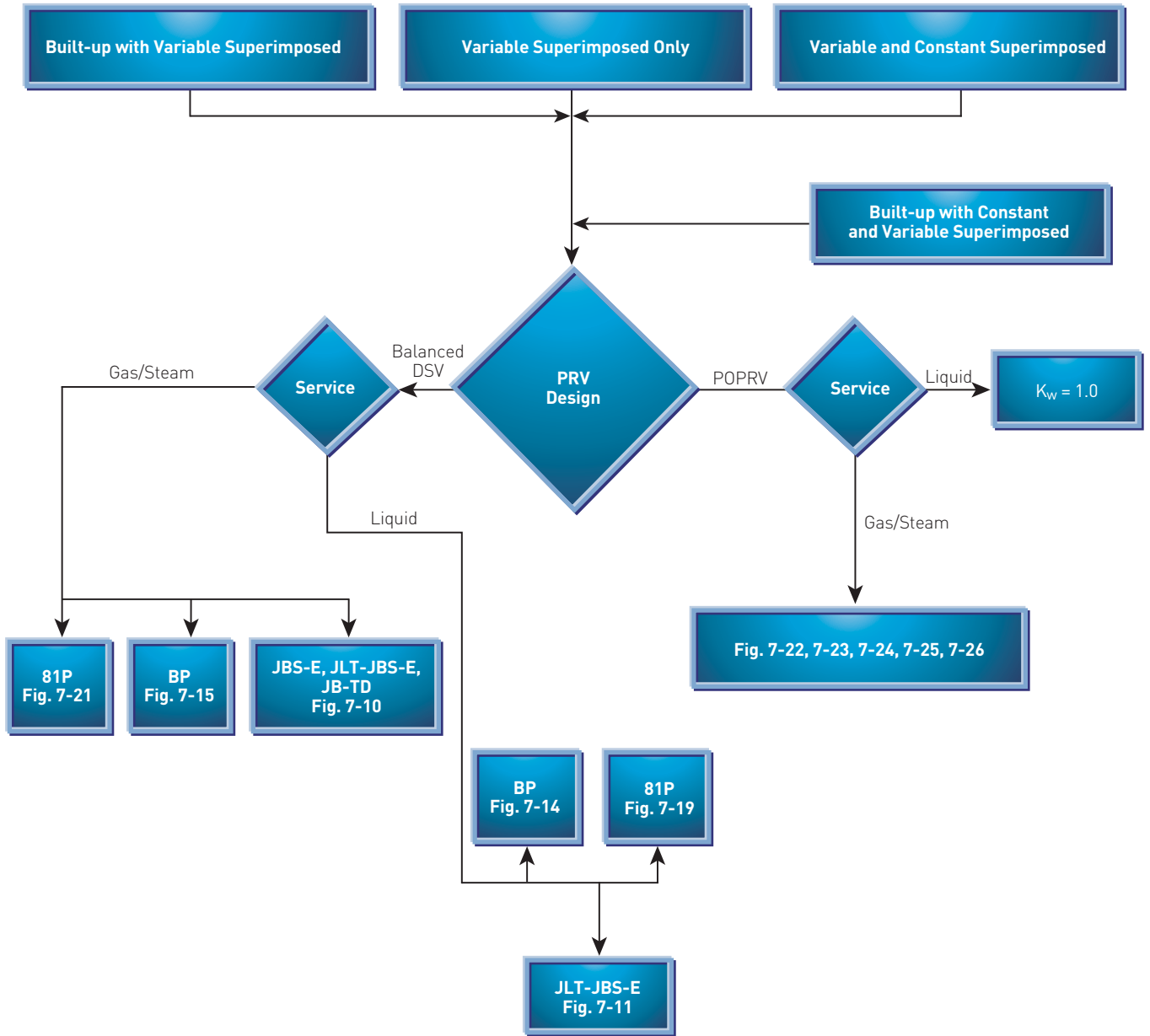


FIGURE 7-7  
 Valve Selection Recommendations for Constant Superimposed Back Pressure Installations with Built-up Back Pressure

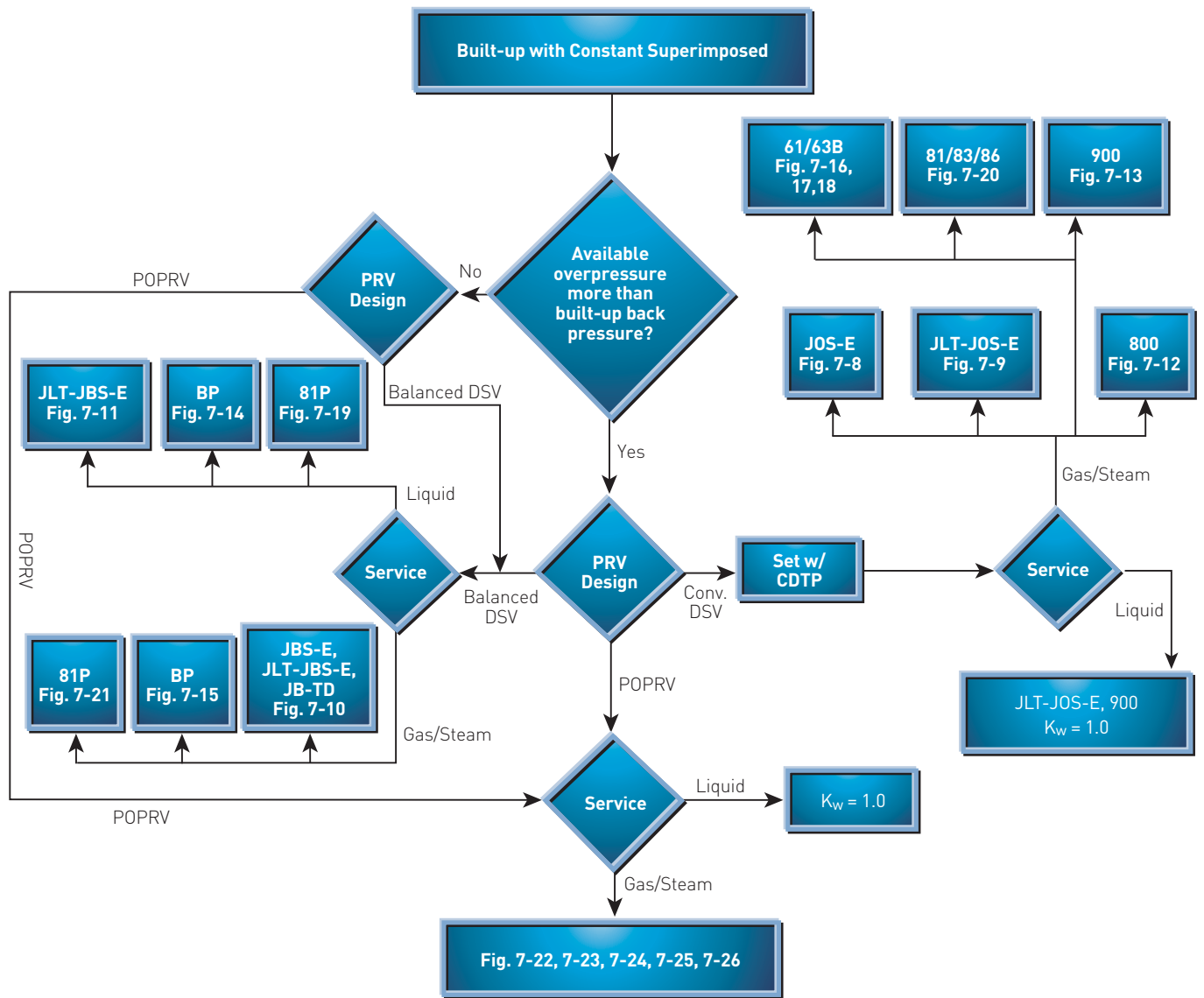
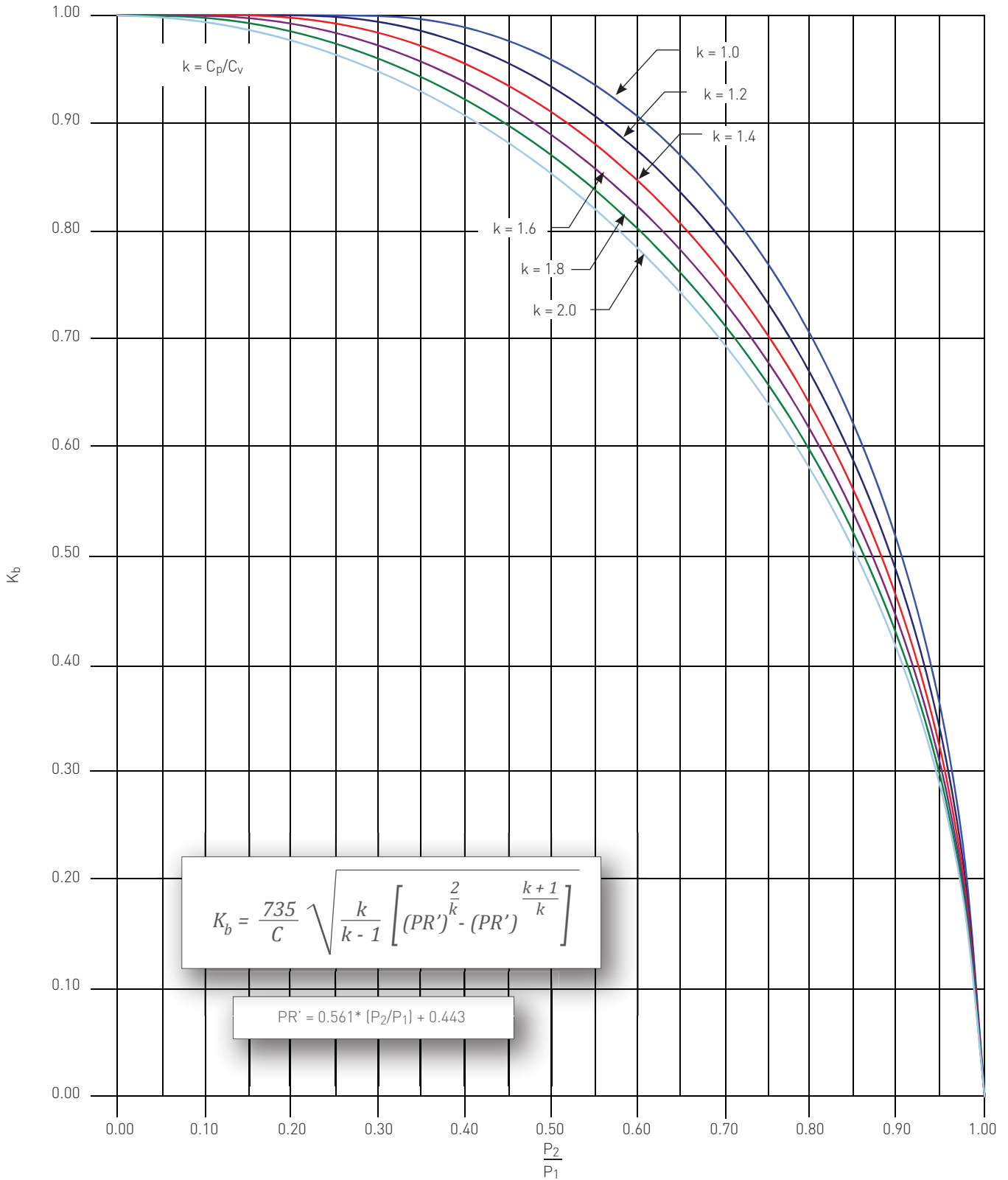




FIGURE 7-8  
 Crosby Series JOS-E Conventional Direct Spring PRV Back Pressure Correction Factor ( $K_b$ ) - Gas/Steam Service

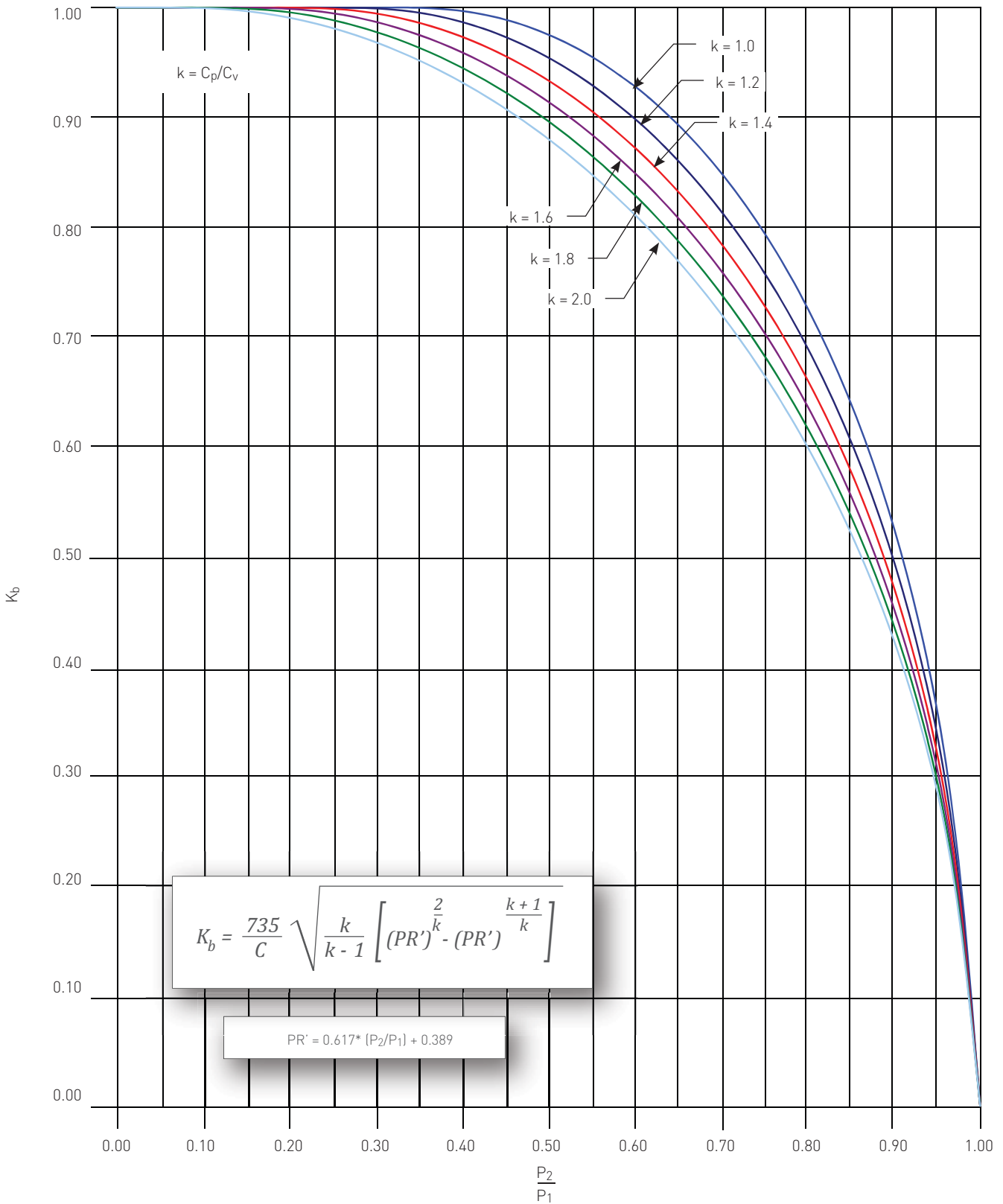


Where:

$P_2$  = Pressure at valve outlet during flow, psia. This is total back pressure (psig) + atmospheric pressure (psia)

$P_1$  = Relieving pressure, psia. This is the set pressure (psig) + overpressure (psig) + atmospheric pressure (psia) - inlet pressure piping loss (psig)

FIGURE 7-9  
 Crosby Series JLT-JOS-E Conventional Direct Spring PRV Back Pressure Correction Factor ( $K_b$ ) - Gas Service

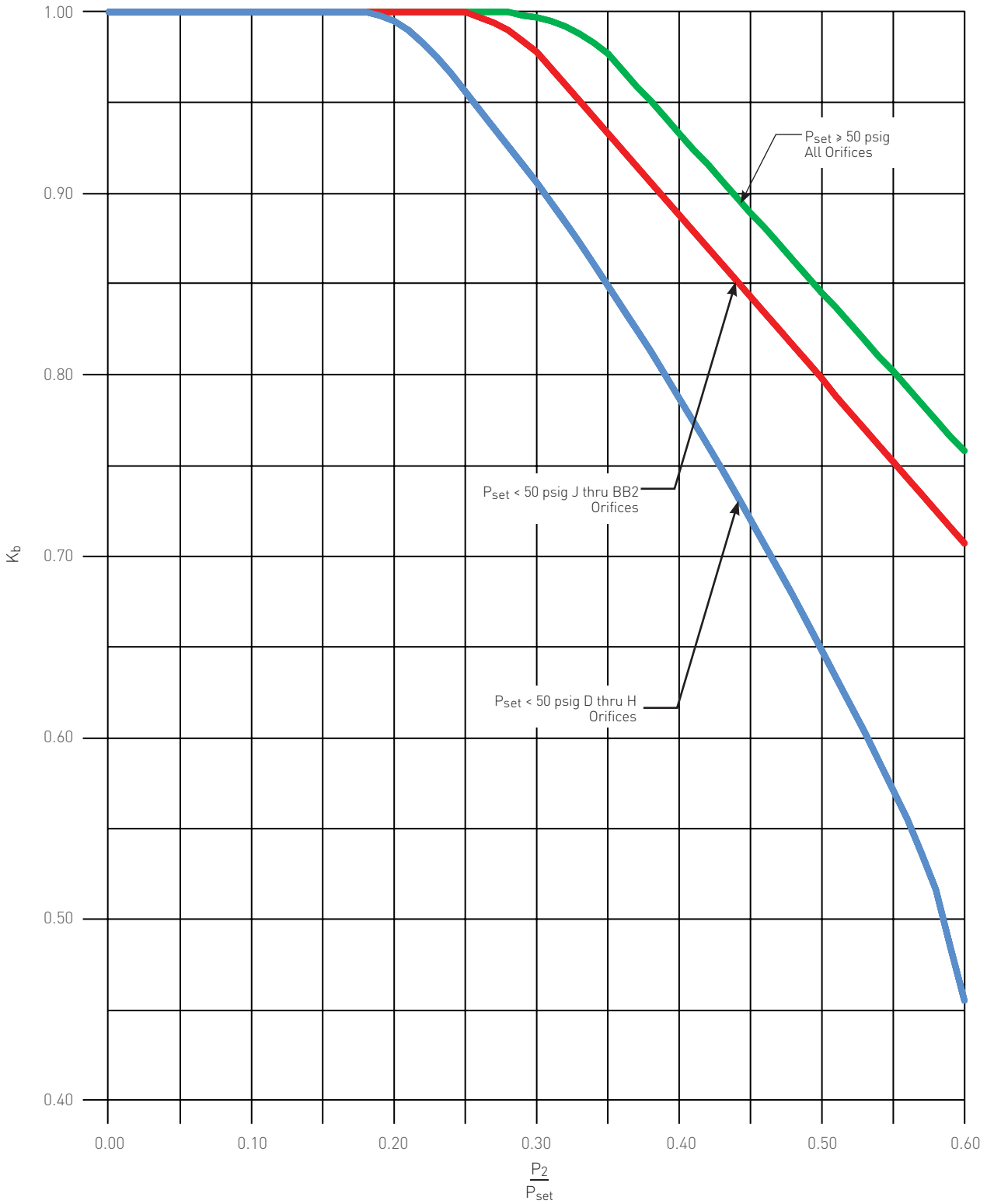


Where:

$P_2$  = Pressure at valve outlet during flow, psia. This is total back pressure (psig) + atmospheric pressure (psia)

$P_1$  = Relieving pressure, psia. This is the set pressure (psig) + overpressure (psig) + atmospheric pressure (psia) - inlet pressure piping loss (psig)

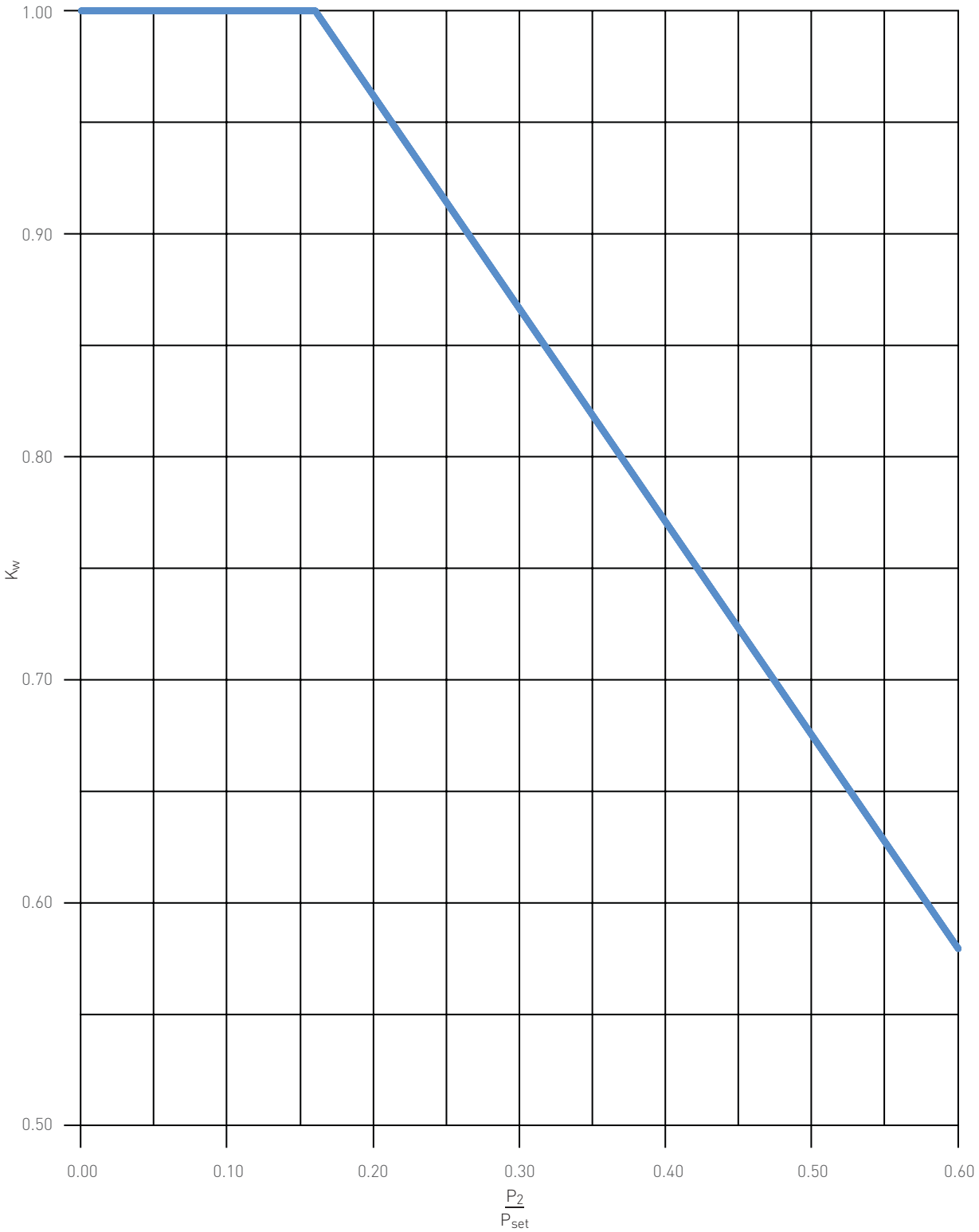
FIGURE 7-10  
 Crosby Series JBS-E/JLT-JBS-E/JB-TD Balanced Bellows Direct Spring PRV Back Pressure Correction Factor ( $K_b$ ) - Gas/Steam Service



Where:  
 $P_2$  = Pressure at valve outlet during flow, psig. This is the total back pressure (psig).  
 $P_{set}$  = Set pressure (psig)

**NOTE**  
 This figure is based upon 10% overpressure.  
 The  $K_b$  factor shown will be conservative for higher overpressure values.

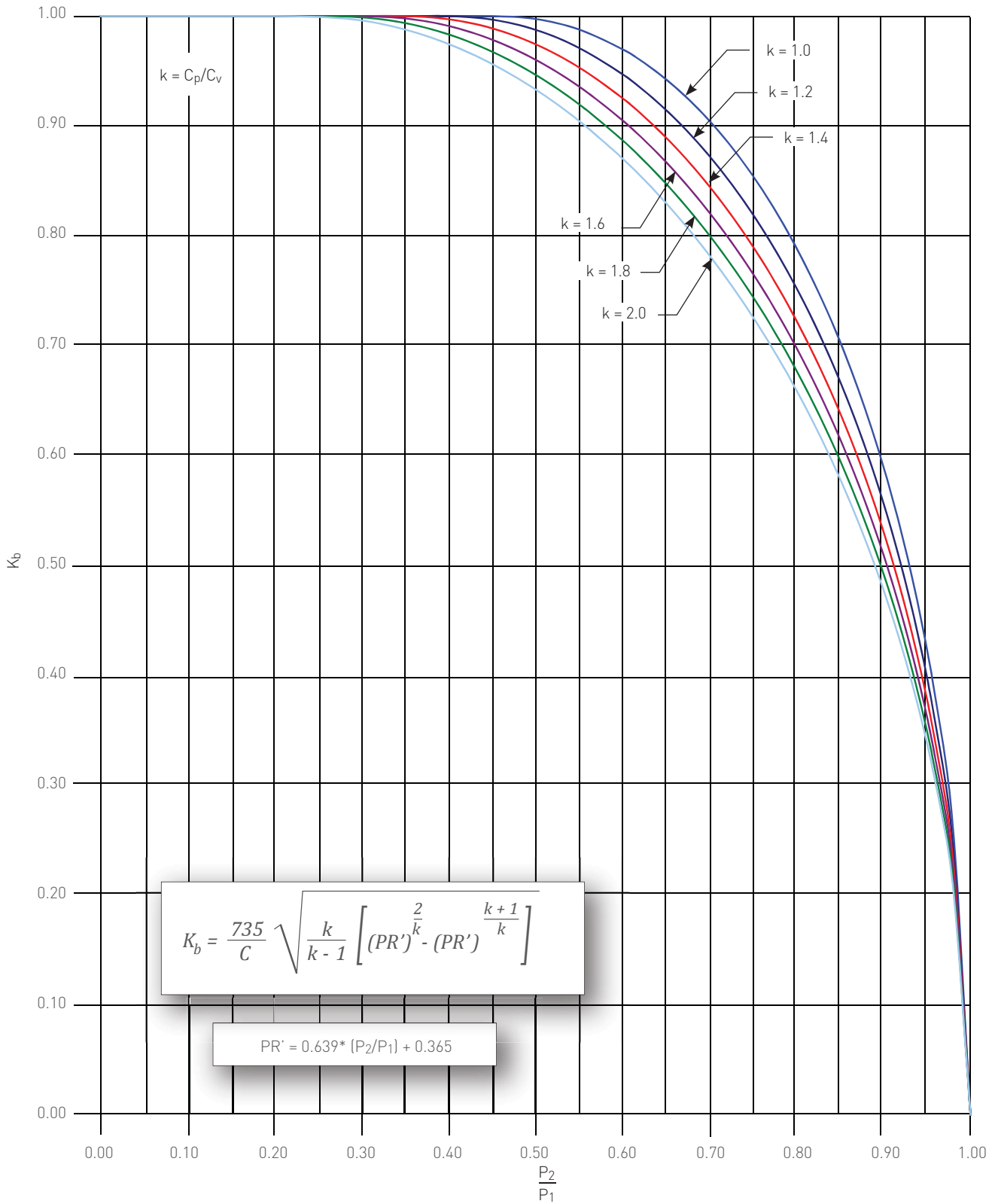
FIGURE 7-11  
 Crosby Series JLT-JBS-E Balanced Bellows Direct Spring PRV Back Pressure Correction Factor ( $K_w$ ) - Liquid Service



Where:  
 $P_2$  = Pressure at valve outlet during flow, psig. This is the total back pressure (psig).  
 $P_{set}$  = Set pressure (psig)

**NOTE**  
 This figure is based upon 10% overpressure.  
 The  $K_w$  factor shown will be conservative for higher overpressure values.

FIGURE 7-12  
 Crosby Series 800 Conventional Direct Spring PRV Back Pressure Correction Factor ( $K_b$ ) - Gas/Steam Service

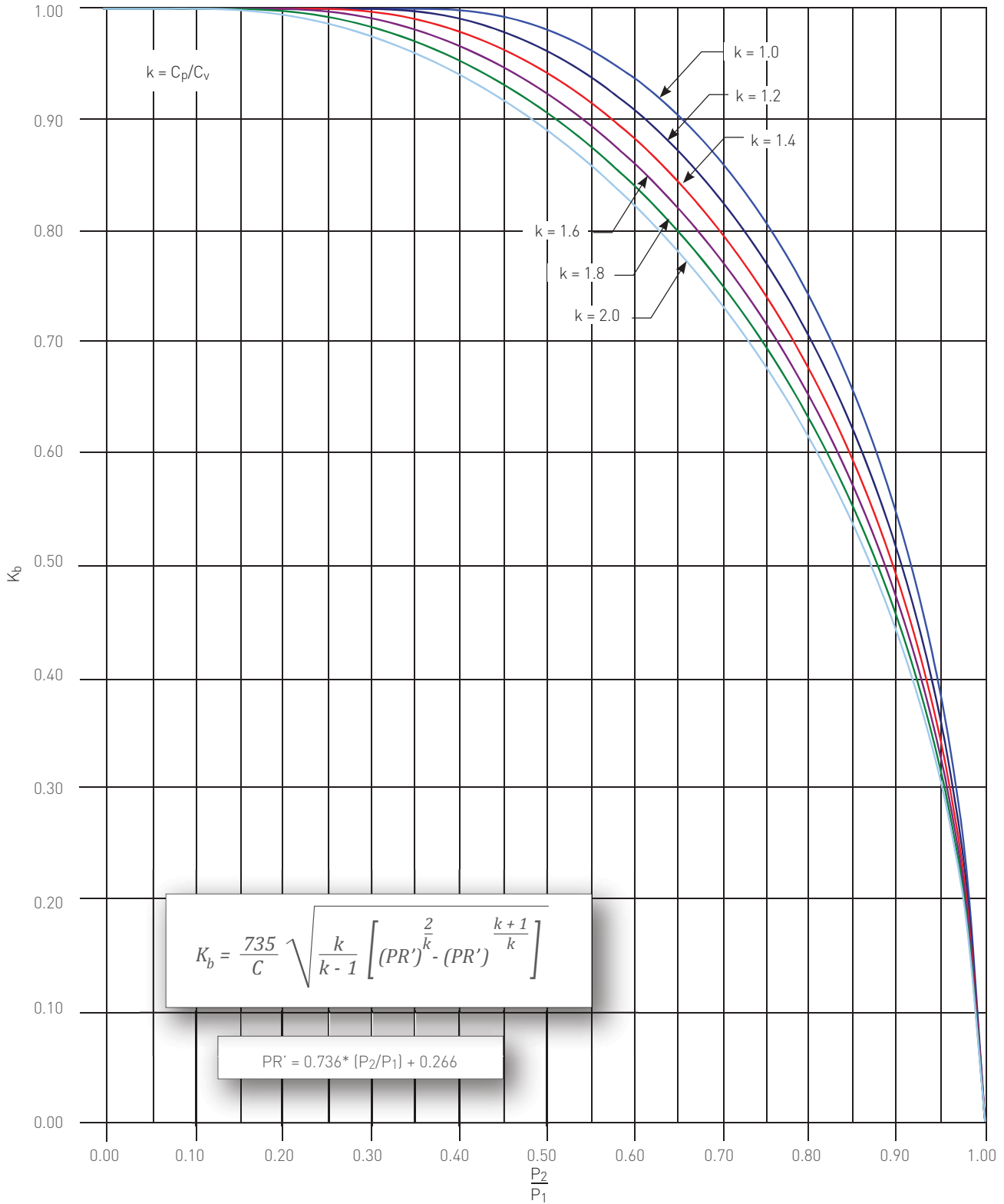


Where:

$P_2$  = Pressure at valve outlet during flow, psia. This is total back pressure (psig) + atmospheric pressure (psia)

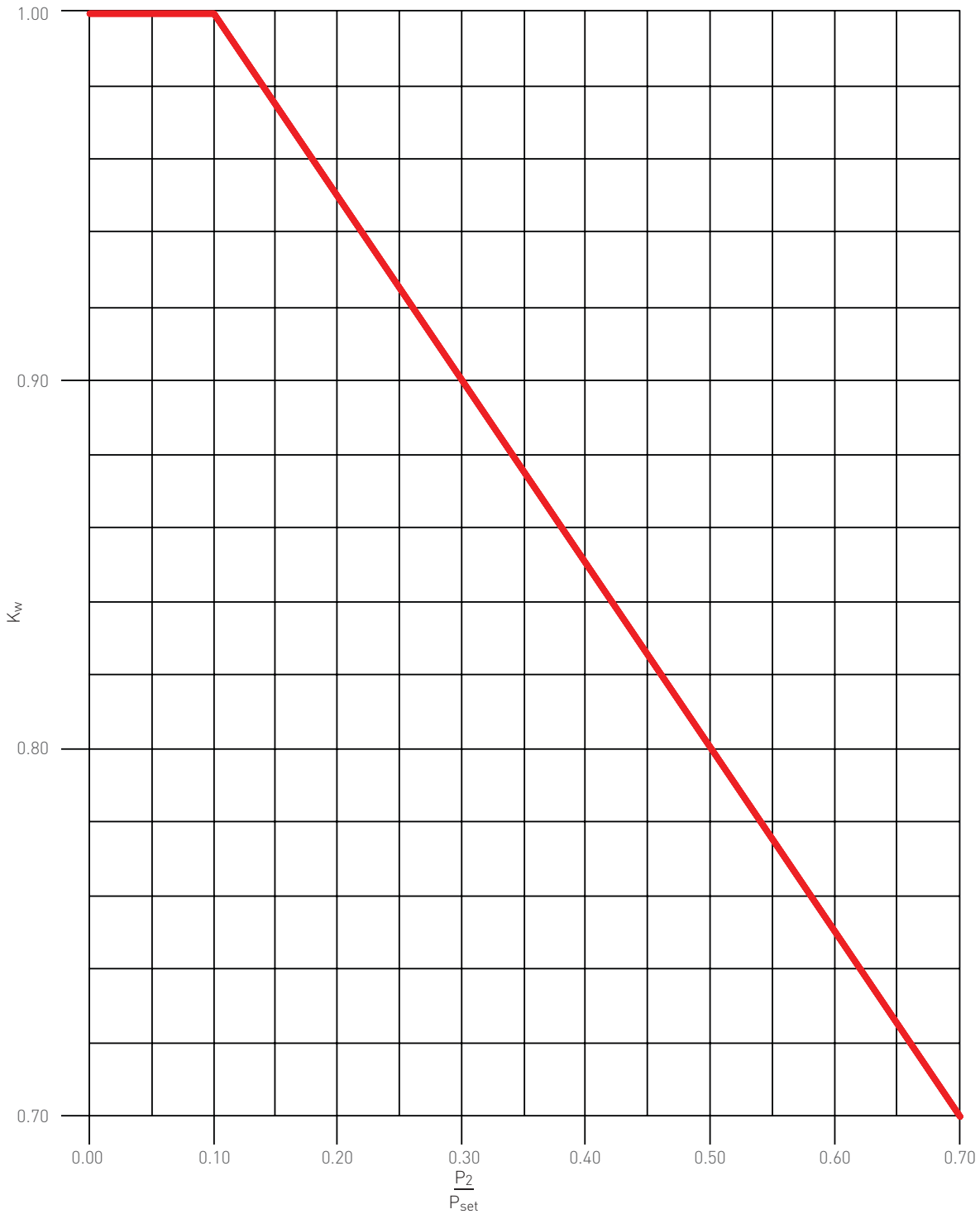
$P_1$  = Relieving pressure, psia. This is the set pressure (psig) + overpressure (psig) + atmospheric pressure (psia) - inlet pressure piping loss (psig)

FIGURE 7-13  
 Crosby Series 900 Conventional Direct Spring PRV Back Pressure Correction Factor ( $K_b$ ) - Gas/Steam Service



Where:  
 $P_2$  = Pressure at valve outlet during flow, psia. This is total back pressure (psig) + atmospheric pressure (psia)  
 $P_1$  = Relieving pressure, psia. This is the set pressure (psig) + overpressure (psig) + atmospheric pressure (psia) - inlet pressure piping loss (psig)

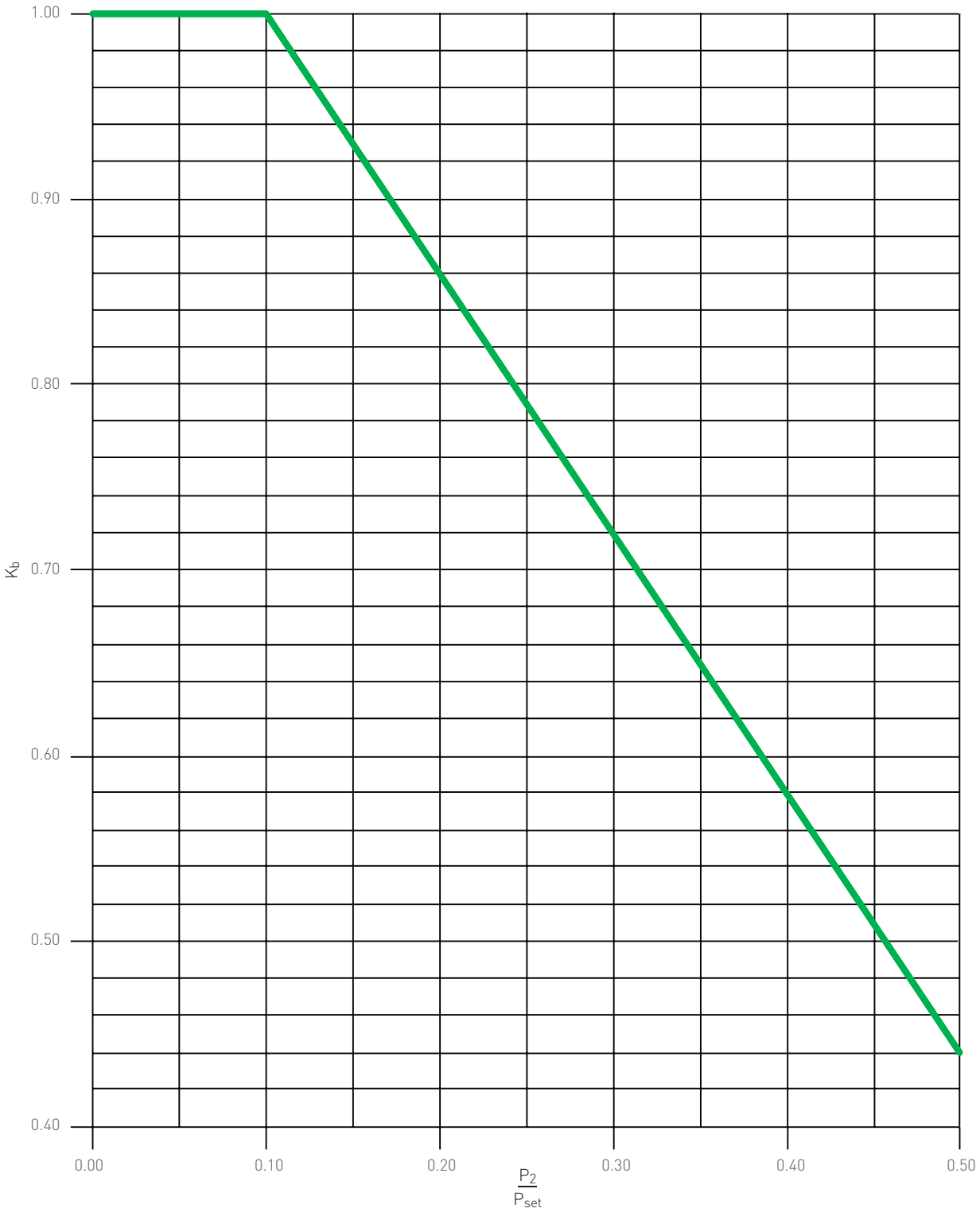
FIGURE 7-14  
 Crosby Series BP Back Pressure Correction Factor ( $K_w$ ) - Liquid Service



Where:  
 $P_2$  = Pressure at valve outlet during flow, psig. This is the total back pressure (psig)  
 $P_{set}$  = Set pressure (psig)

**NOTE**  
 This figure is based upon 10% overpressure.  
 The  $K_w$  factor shown will be conservative for higher overpressure values.

FIGURE 7-15  
 Crosby Series BP Back Pressure Correction Factor ( $K_b$ ) - Gas Service

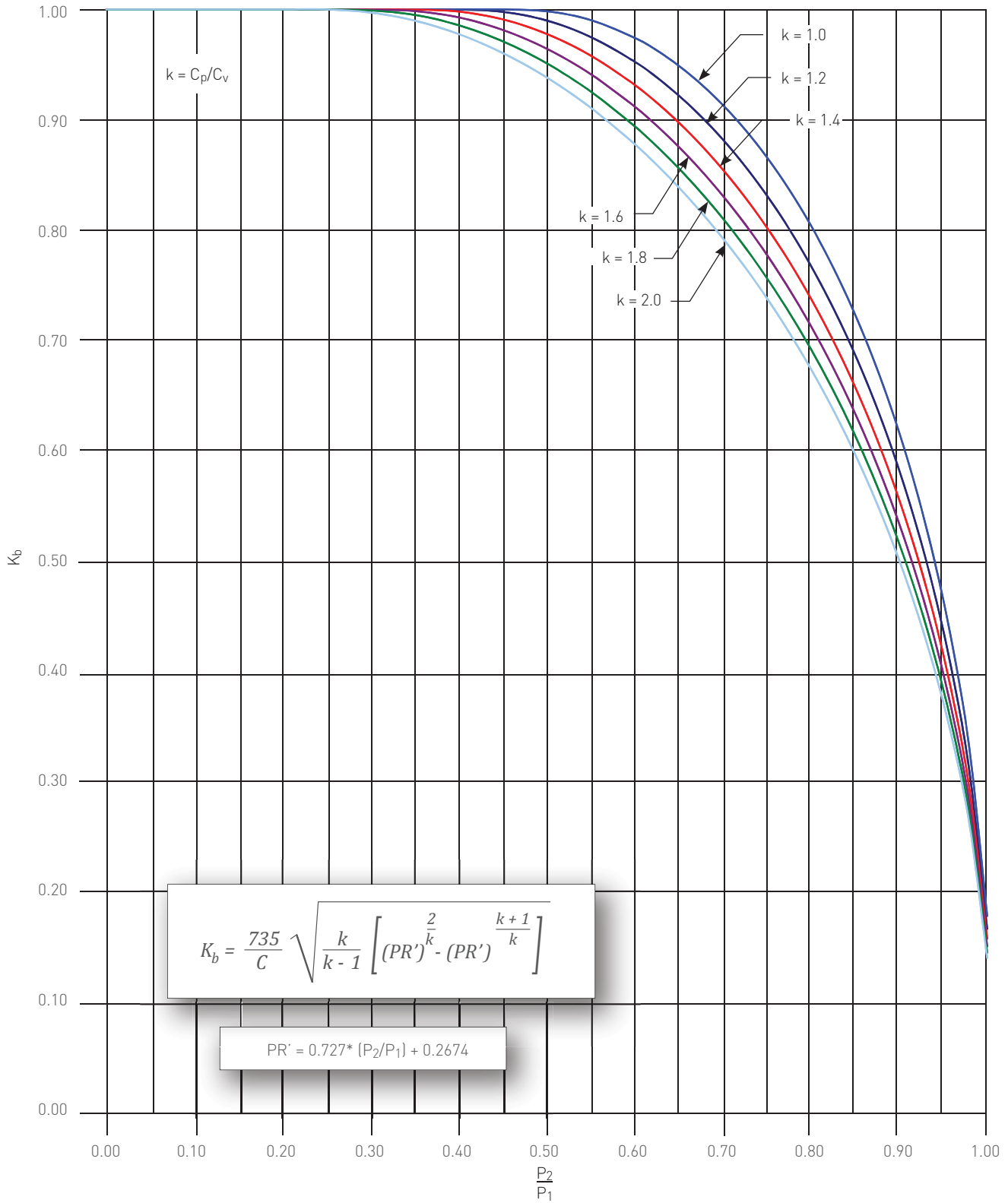


Where:  
 $P_2$  = Pressure at valve outlet during flow, psig. This is the total back pressure (psig)  
 $P_{set}$  = Set pressure (psig)

**NOTE**  
 This figure is based upon 10% overpressure.  
 The  $K_b$  factor shown will be conservative for higher overpressure values.

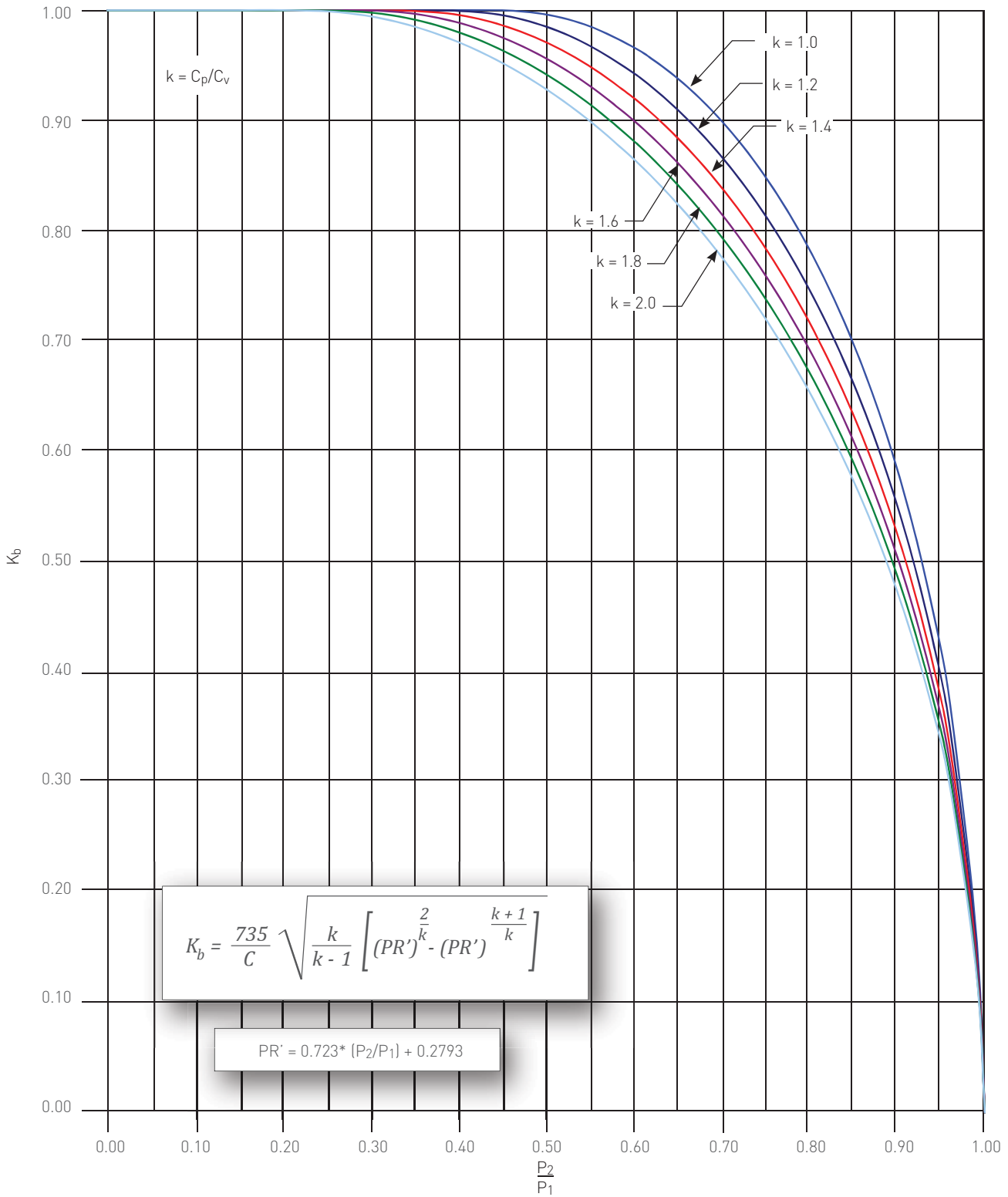


FIGURE 7-16  
 Anderson Greenwood Series 61 Conventional Direct Spring PRV Back Pressure Correction Factor ( $K_b$ ) - Gas Service



Where:  
 $P_2$  = Pressure at valve outlet during flow, psia. This is total back pressure (psig) + atmospheric pressure (psia)  
 $P_1$  = Relieving pressure, psia. This is the set pressure (psig) + overpressure (psig) + atmospheric pressure (psia) - inlet pressure piping loss (psig)

FIGURE 7-17  
 Anderson Greenwood Series 63B (-5 Orifice Only) Conventional Direct Spring PRV Back Pressure Correction Factor (K<sub>b</sub>) - Gas Service

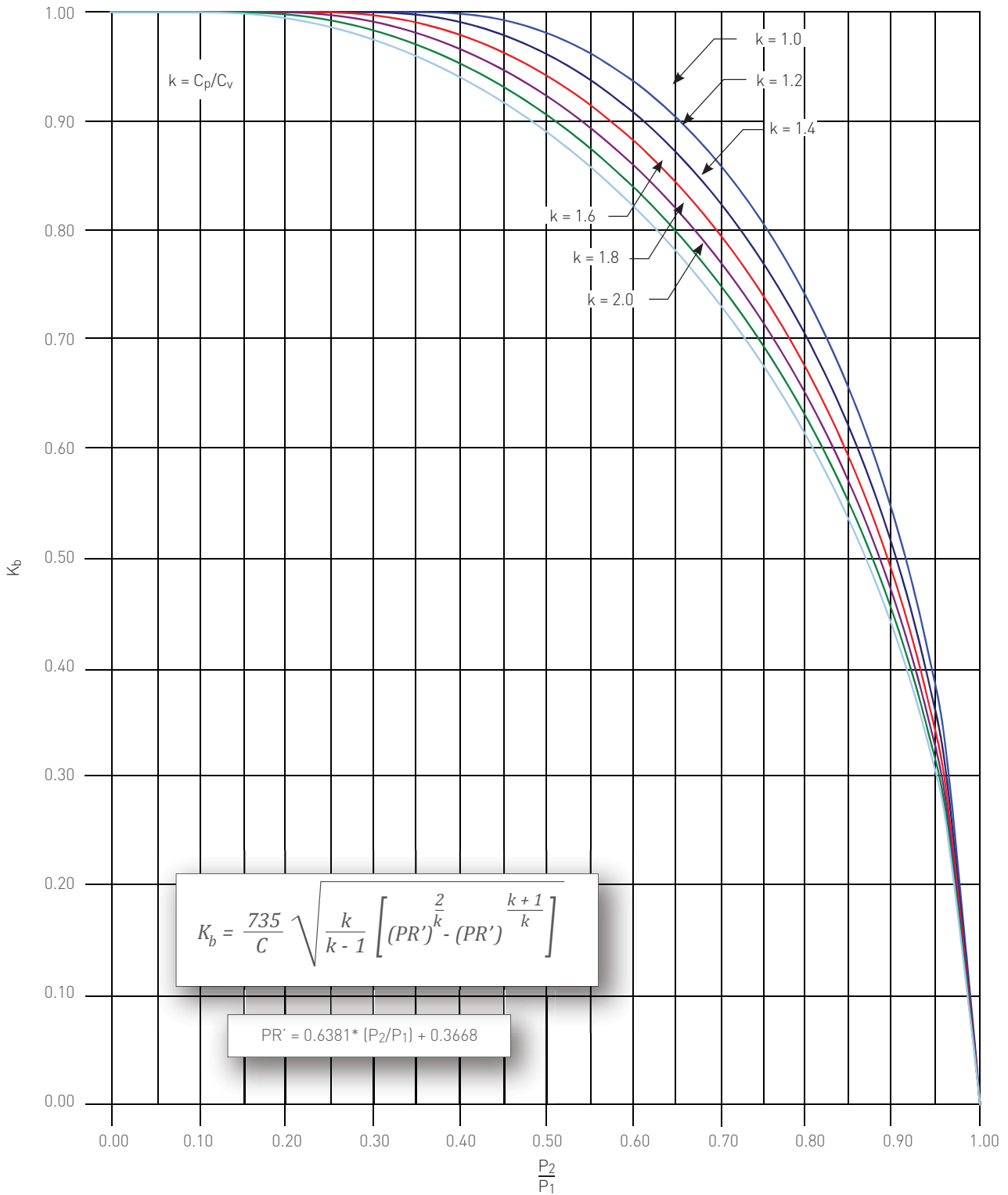


Where:

$P_2$  = Pressure at valve outlet during flow, psia. This is total back pressure (psig) + atmospheric pressure (psia)

$P_1$  = Relieving pressure, psia. This is the set pressure (psig) + overpressure (psig) + atmospheric pressure (psia) - inlet pressure piping loss (psig)

FIGURE 7-18  
 Anderson Greenwood Series 63B (-7 Orifice Only) Conventional Direct Acting PRV Back Pressure Correction Factor ( $K_b$ ) - Gas Service

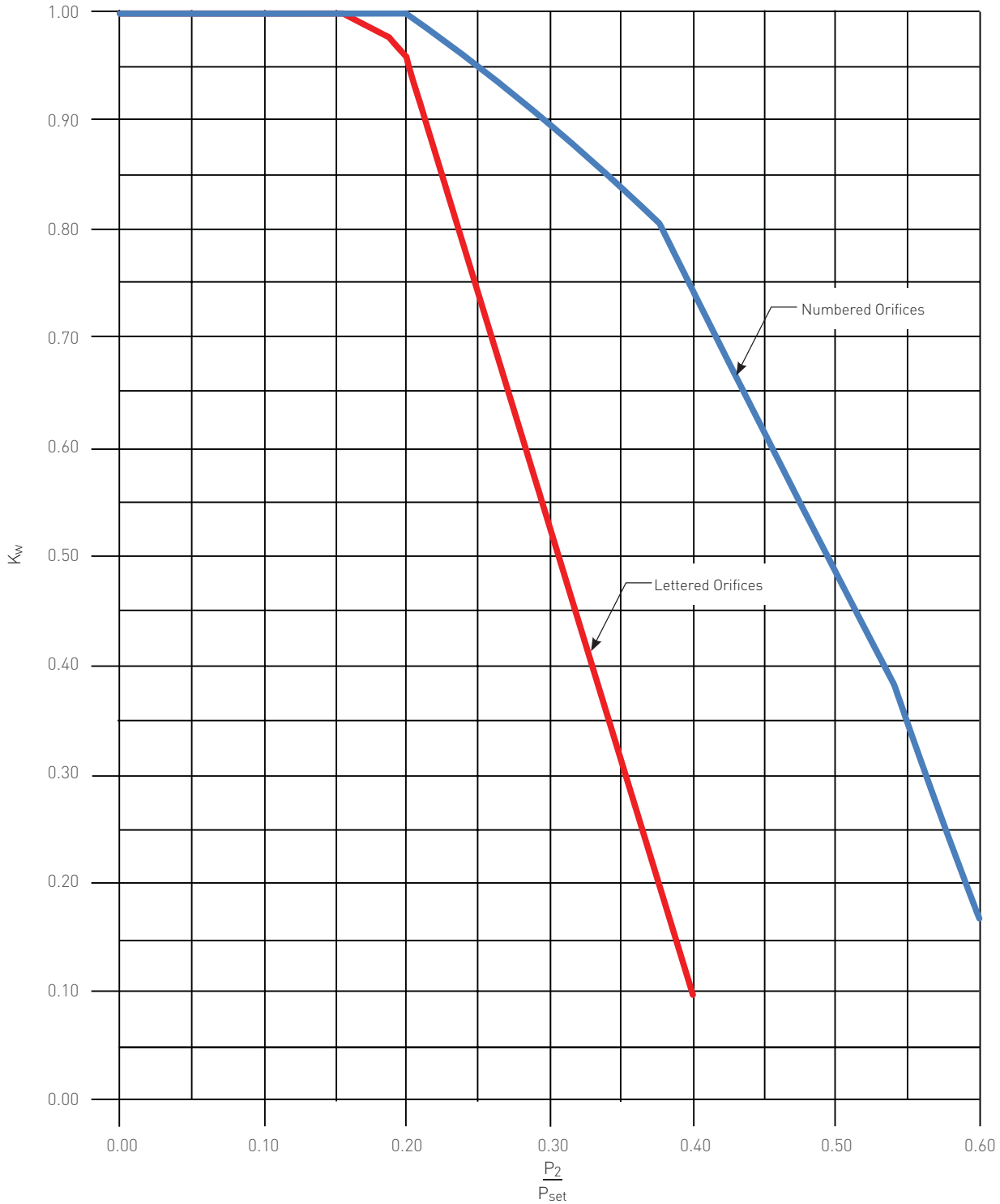


Where:

$P_2$  = Pressure at valve outlet during flow, psia. This is total back pressure (psig) + atmospheric pressure (psia)

$P_1$  = Relieving pressure, psia. This is the set pressure (psig) + overpressure (psig) + atmospheric pressure (psia) - inlet pressure piping loss (psig)

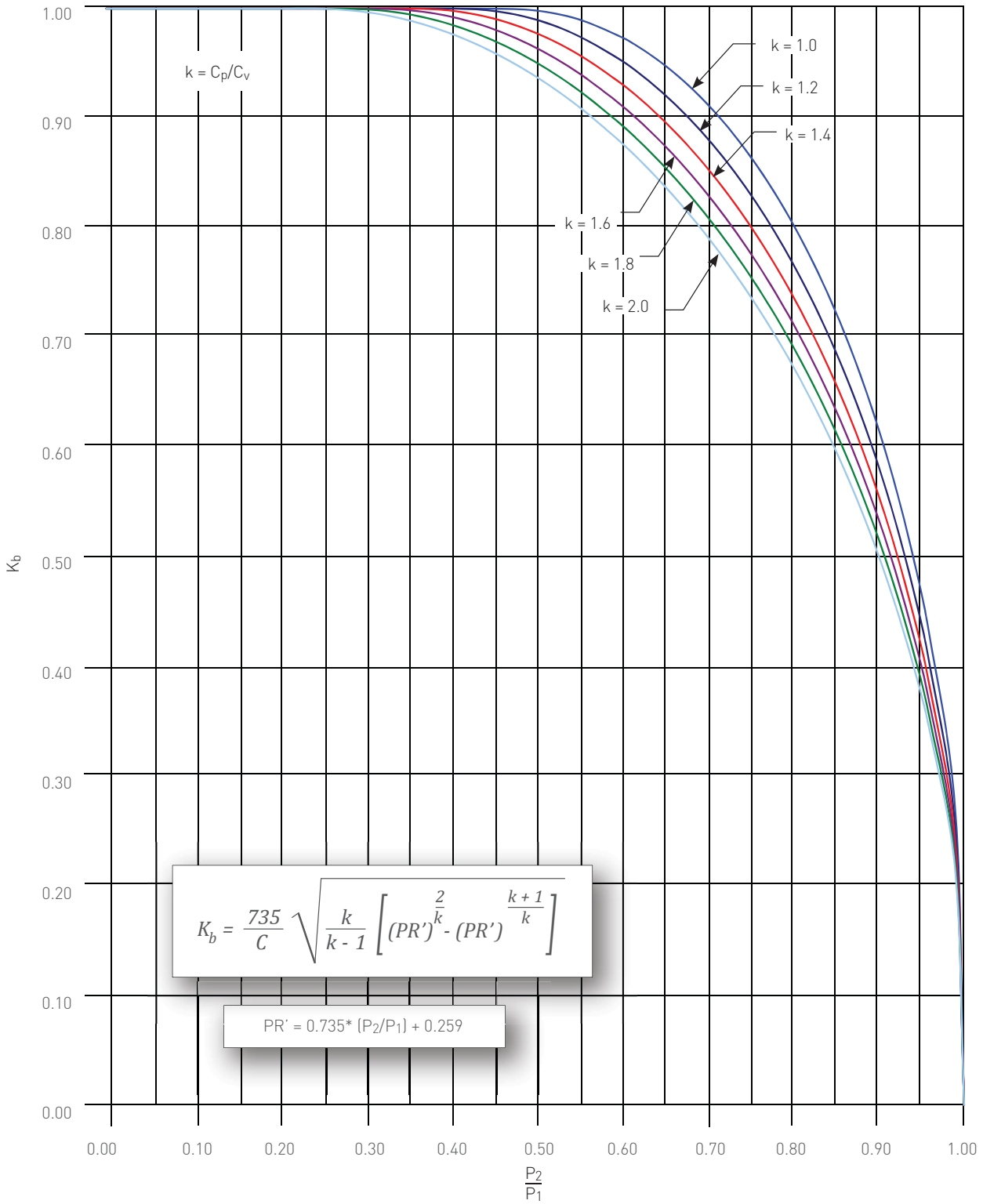
FIGURE 7-19  
 Anderson Greenwood Series 81P Back Pressure Correction Factor ( $K_w$ ) - Liquid Service



Where:  
 $P_2$  = Pressure at valve outlet during flow, psig. This is the total back pressure (psig)  
 $P_{set}$  = Set pressure (psig)

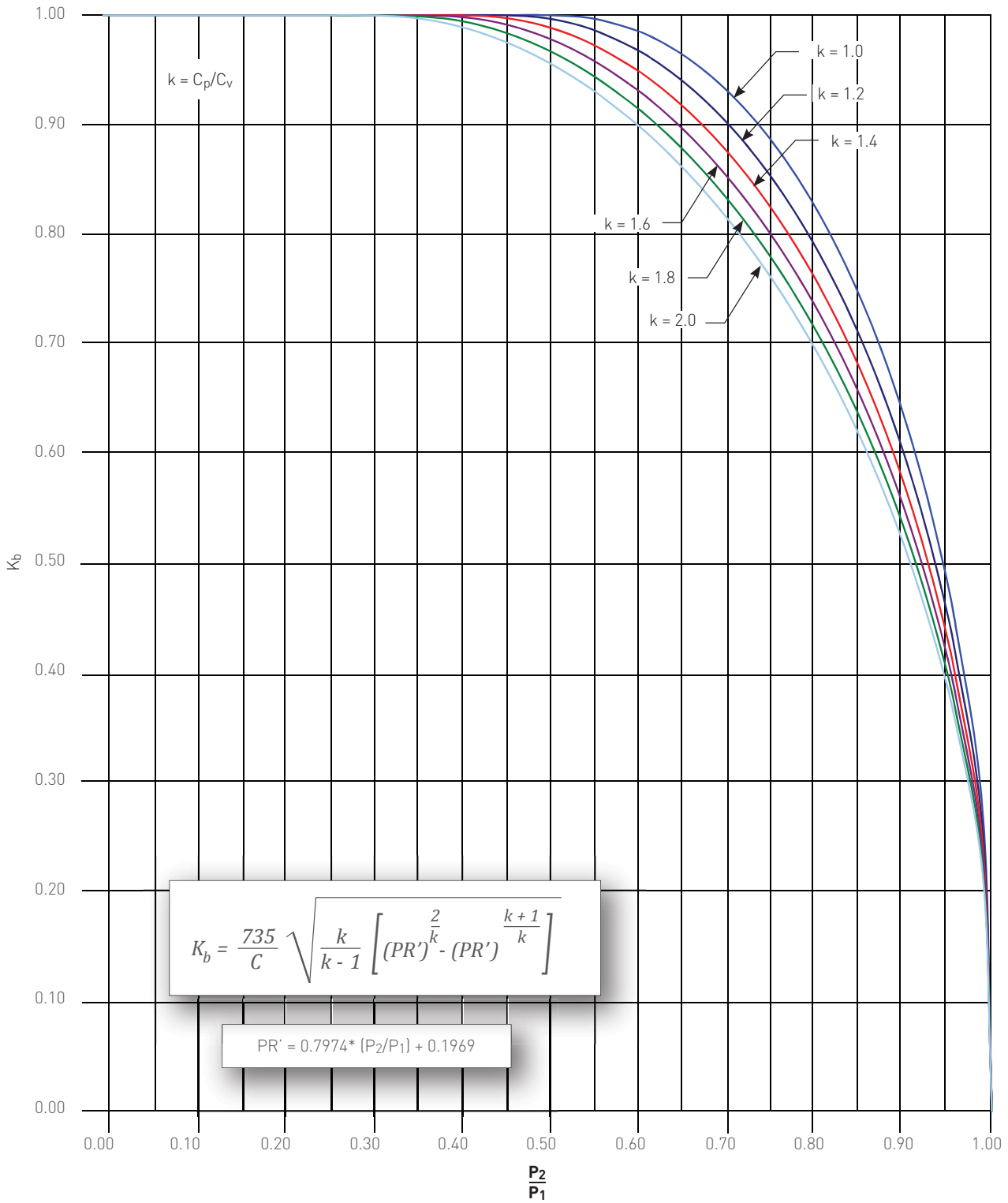
**NOTE**  
 This figure is based upon 10% overpressure.  
 The  $K_w$  factor shown will be conservative for higher overpressure values.

FIGURE 7-20  
 Anderson Greenwood Series 81/83/86 Conventional Direct Spring PRV Back Pressure Correction Factor ( $K_b$ ) - Gas/Steam Service



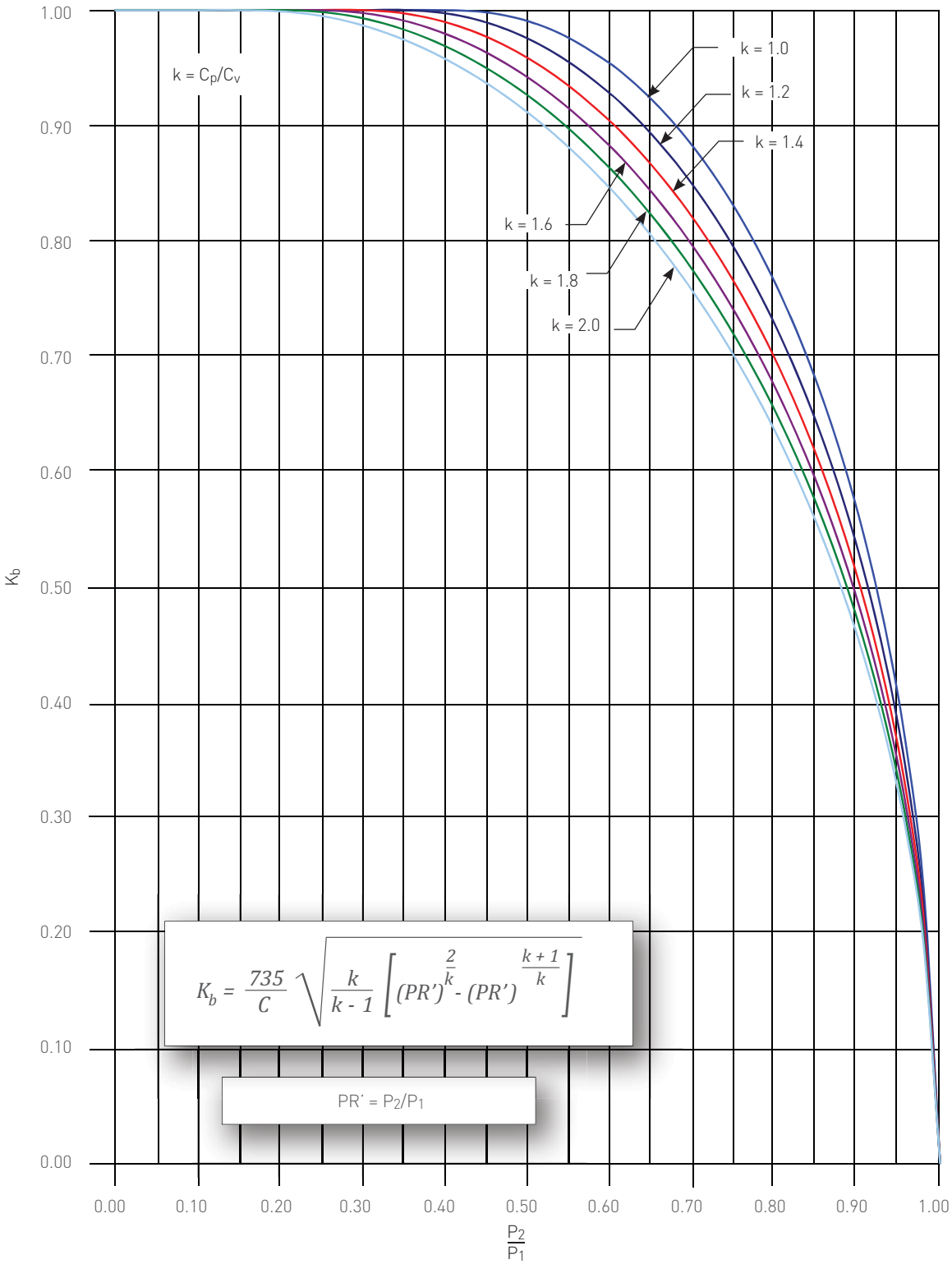
Where:  
 $P_2$  = Pressure at valve outlet during flow, psia. This is total back pressure (psig) + atmospheric pressure (psia)  
 $P_1$  = Relieving pressure, psia. This is the set pressure (psig) + overpressure (psig) + atmospheric pressure (psia) - inlet pressure piping loss (psig)

FIGURE 7-21  
 Anderson Greenwood Series 81P (-8 Orifice Only) Balanced Piston Direct Spring PRV Back Pressure Correction Factor ( $K_b$ ) - Gas Service



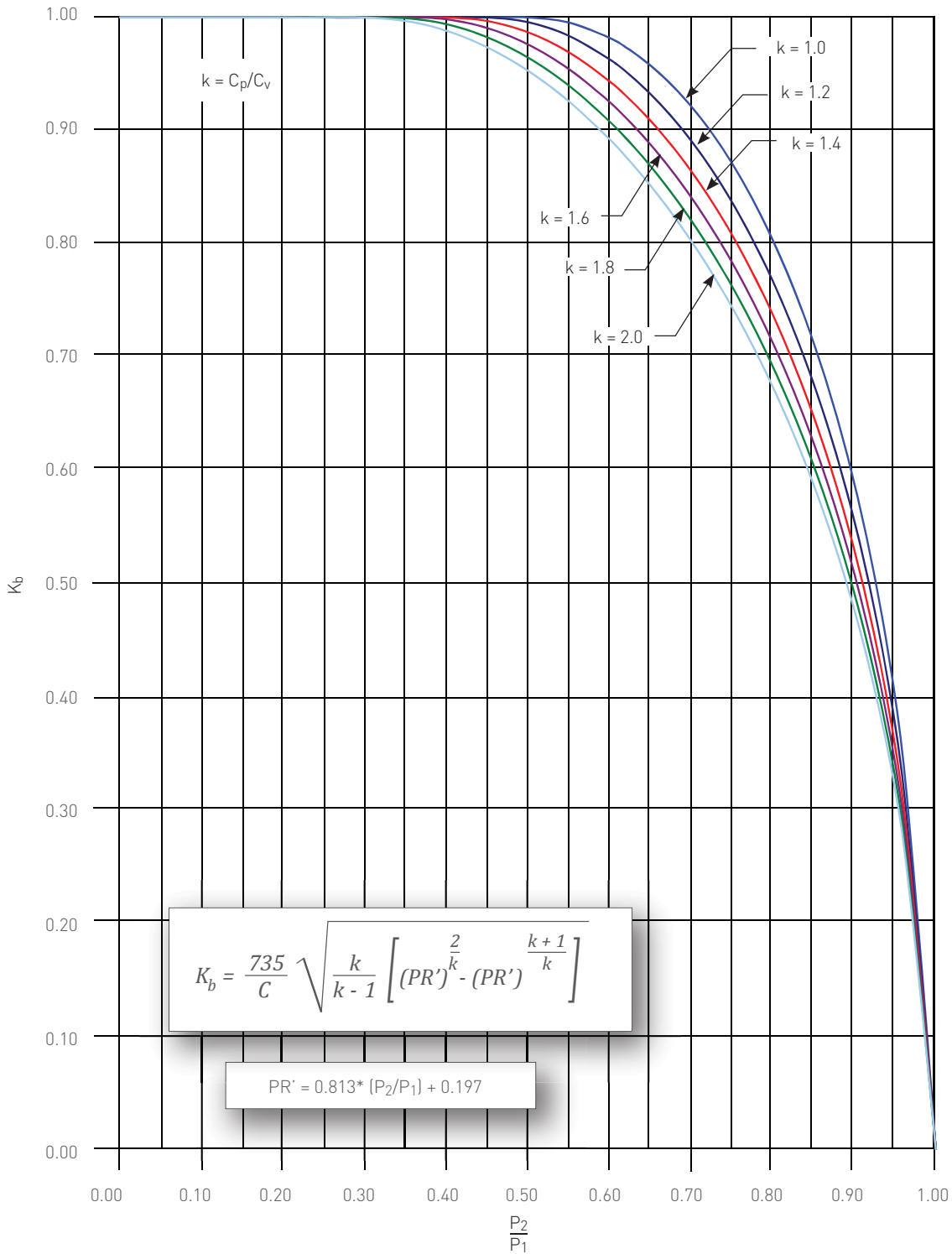
Where:  
 $P_2$  = Pressure at valve outlet during flow, psia. This is total back pressure (psig) + atmospheric pressure (psia)  
 $P_1$  = Relieving pressure, psia. This is the set pressure (psig) + overpressure (psig) + atmospheric pressure (psia) - inlet pressure piping loss (psig)

FIGURE 7-22  
 Anderson Greenwood Series 90/9000 - POPRV Back Pressure Correction Factor ( $K_b$ ) - Gas Service



Where:  
 $P_2$  = Pressure at valve outlet during flow, psia. This is total back pressure (psig) + atmospheric pressure (psia)  
 $P_1$  = Relieving pressure, psia. This is the set pressure (psig) + overpressure (psig) + atmospheric pressure (psia) - inlet pressure piping loss (psig)

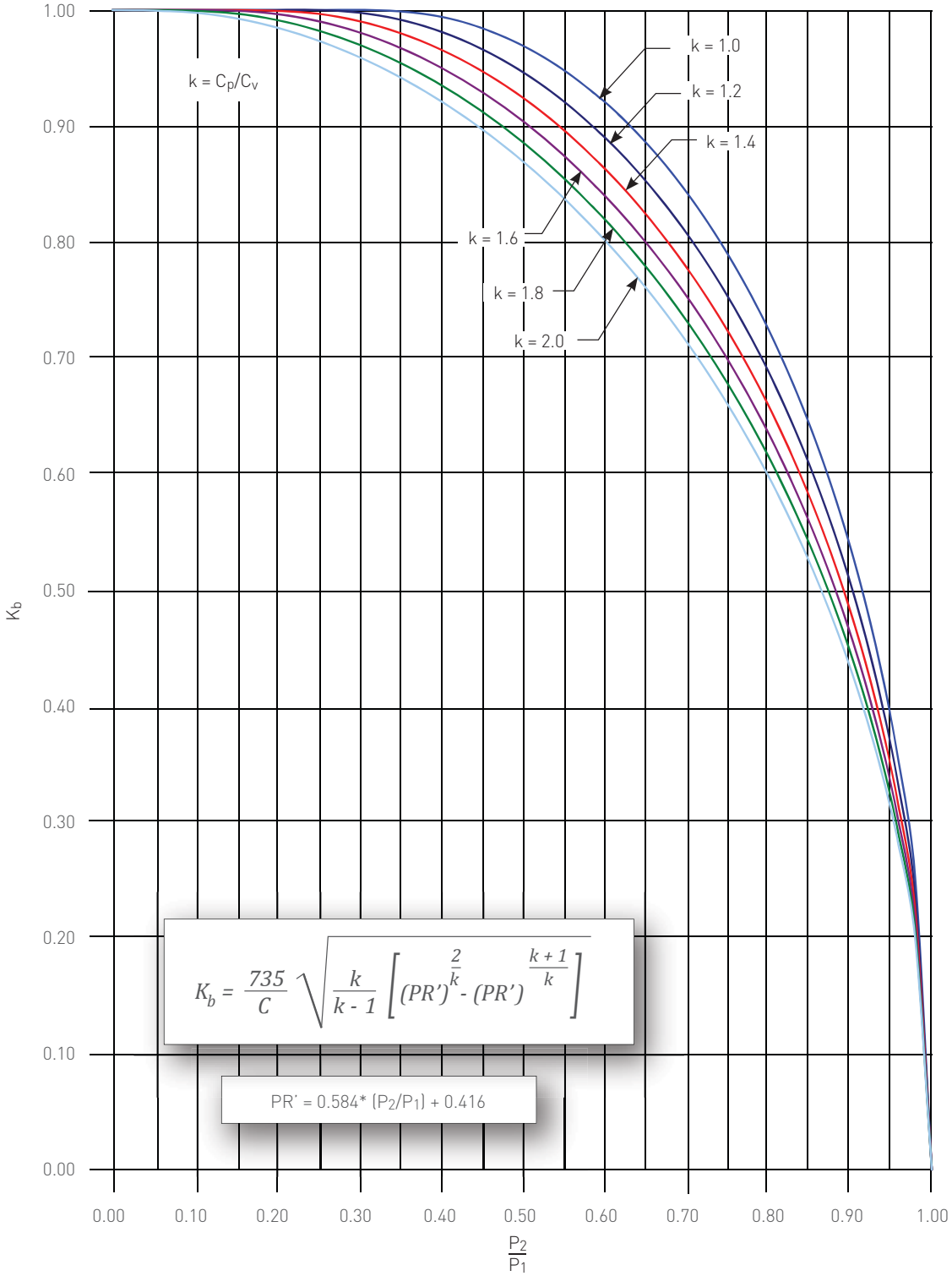
FIGURE 7-23  
 Anderson Greenwood Series 40 Pilot Operated PRV Back Pressure Correction Factor ( $K_b$ ) - Gas/Steam Service



Where:  
 $P_2$  = Pressure at valve outlet during flow, psia. This is total back pressure (psig) + atmospheric pressure (psia)  
 $P_1$  = Relieving pressure, psia. This is the set pressure (psig) + overpressure (psig) + atmospheric pressure (psia) - inlet pressure piping loss (psig)

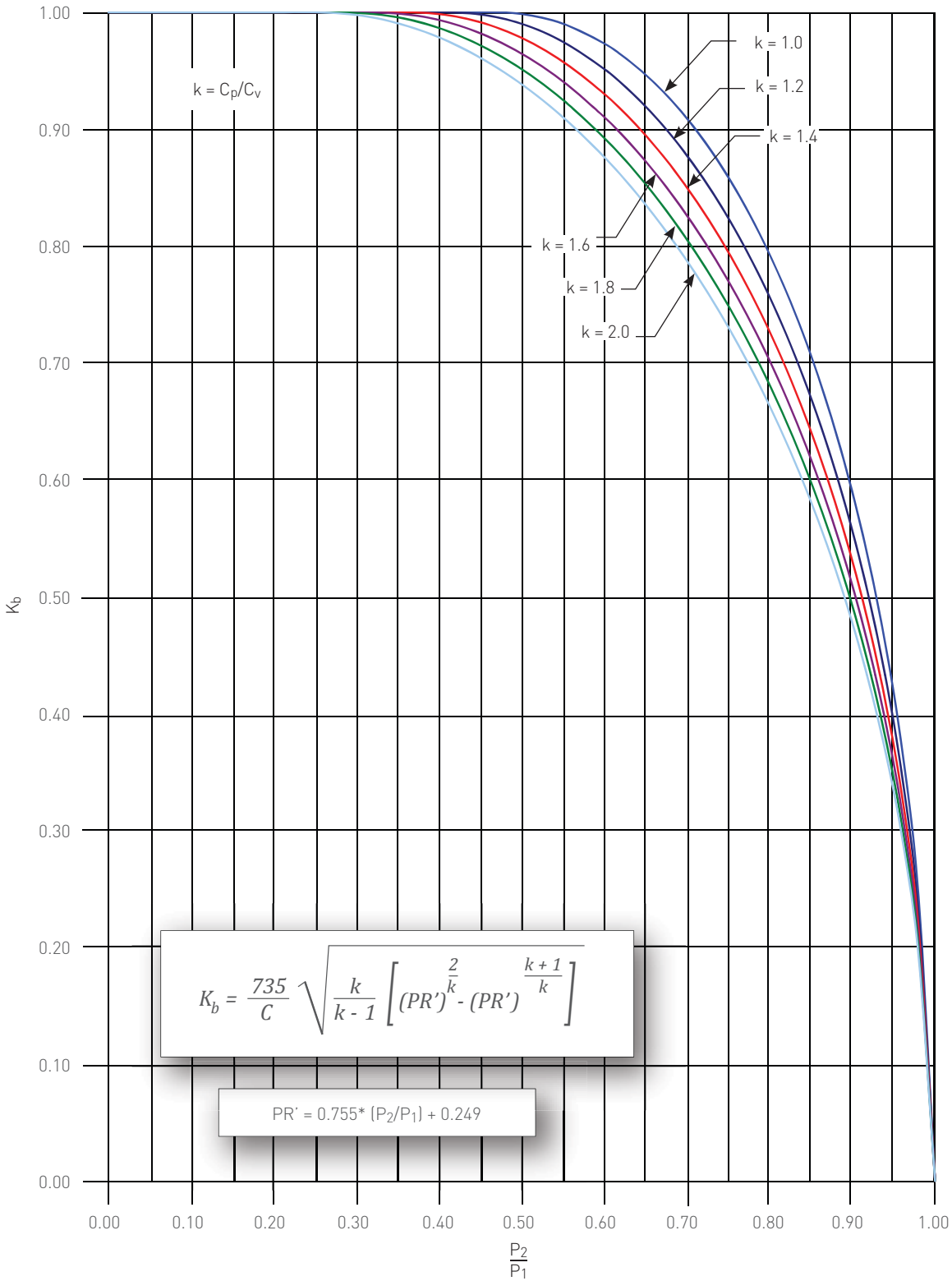


FIGURE 7-24  
 Anderson Greenwood Series 50 Pilot Operated PRV Back Pressure Correction Factor ( $K_b$ ) - Gas/Steam Service



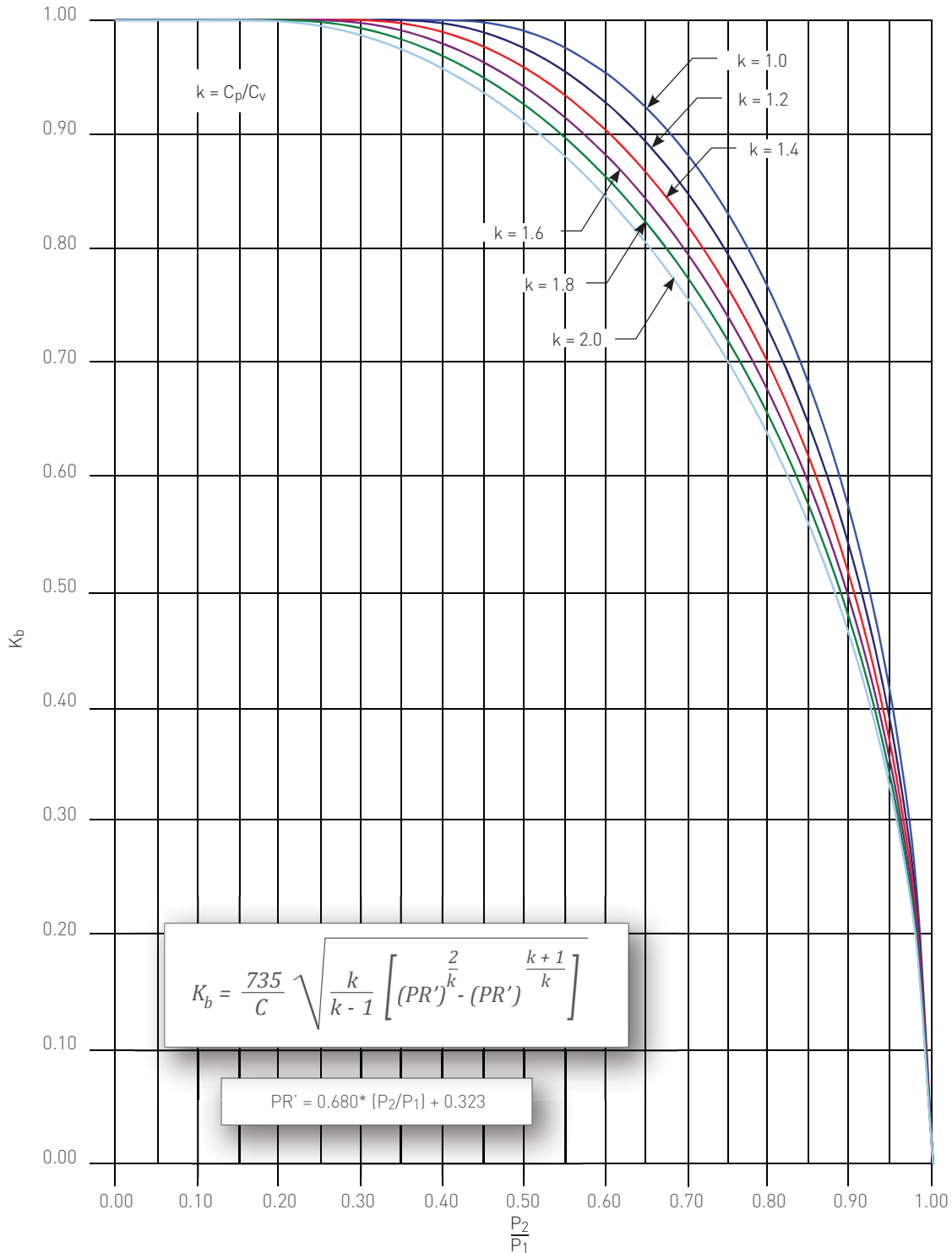
Where:  
 $P_2$  = Pressure at valve outlet during flow, psia. This is total back pressure (psig) + atmospheric pressure (psia)  
 $P_1$  = Relieving pressure, psia. This is the set pressure (psig) + overpressure (psig) + atmospheric pressure (psia) - inlet pressure piping loss (psig)

FIGURE 7-25  
 Anderson Greenwood Series 60 Pilot Operated PRV Back Pressure Correction Factor ( $K_b$ ) - Gas/Steam Service



Where:  
 $P_2$  = Pressure at valve outlet during flow, psia. This is total back pressure (psig) + atmospheric pressure (psia)  
 $P_1$  = Relieving pressure, psia. This is the set pressure (psig) + overpressure (psig) + atmospheric pressure (psia) - inlet pressure piping loss (psig)

FIGURE 7-26  
 Anderson Greenwood Series LCP Pilot Operated PRV Back Pressure Correction Factor ( $K_b$ ) - Gas Service

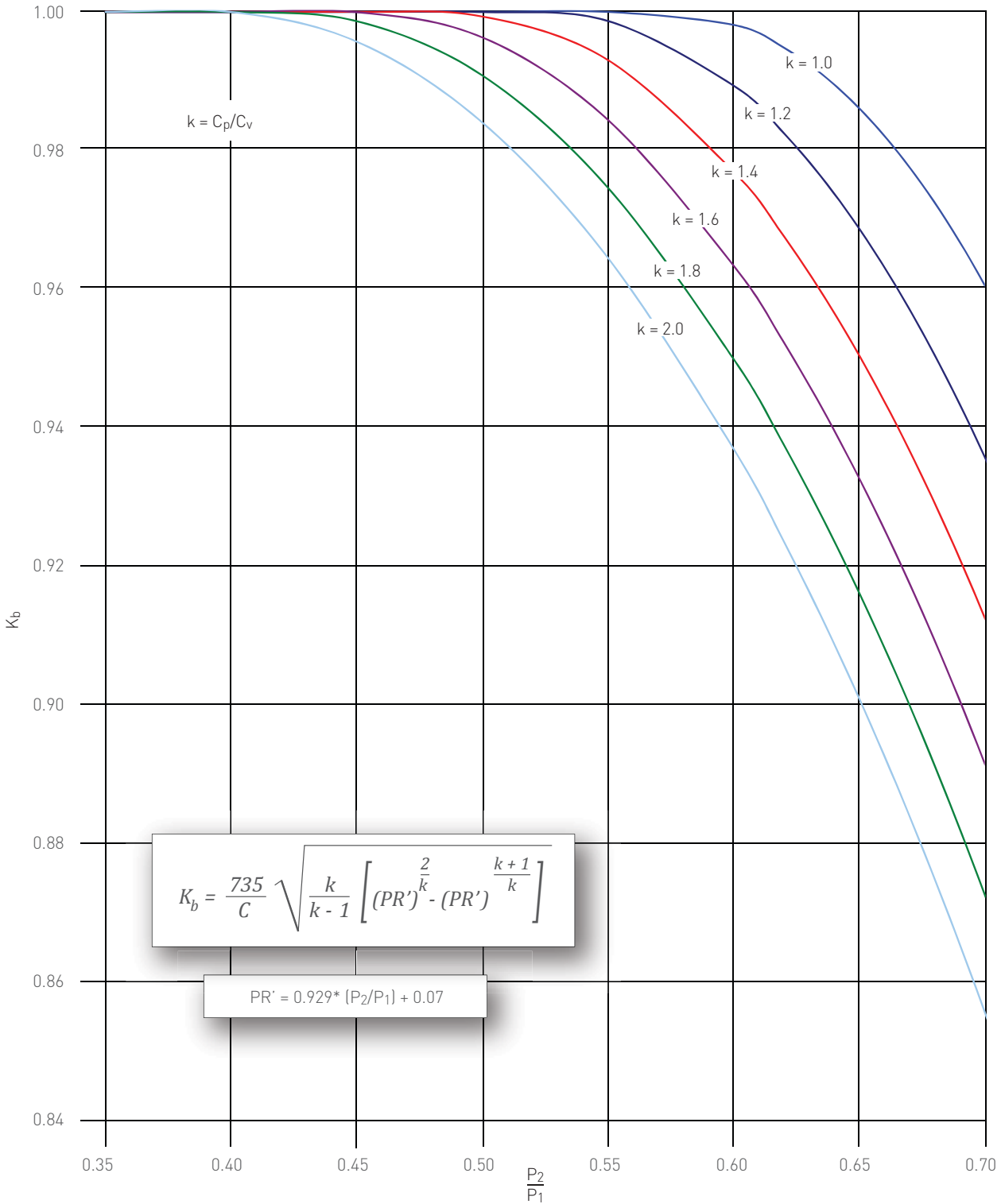


Where:

$P_2$  = Pressure at valve outlet during flow, psia. This is total back pressure (psig) + atmospheric pressure (psia)

$P_1$  = Relieving pressure, psia. This is the set pressure (psig) + overpressure (psig) + atmospheric pressure (psia) - inlet pressure piping loss (psig)

FIGURE 7-27  
 Anderson Greenwood Series 727 Pilot Operated PRV Back Pressure Correction Factor ( $K_b$ ) - Gas/Steam Service



Where:  
 $P_2$  = Pressure at valve outlet during flow, psia. This is total back pressure (psig) + atmospheric pressure (psia)  
 $P_1$  = Relieving pressure, psia. This is the set pressure (psig) + overpressure (psig) + atmospheric pressure (psia) - inlet pressure piping loss (psig)

**III. CAPACITY CORRECTION FACTOR FOR HIGH PRESSURE STEAM,  $K_n$**

The high pressure steam correction factor  $K_n$  is used when steam relieving pressure  $P_1$  is greater than 1500 psia and less than or equal to 3200 psia. This factor has been adopted by ASME to account for the deviation between steam flow as determined by Napier’s equation and actual saturated steam flow at high pressures.  $K_n$  may be calculated by the following equation or may be taken from Figure 7-28.

USCS Units:

$$K_n = \frac{0.1906P_1 - 1000}{0.2292P_1 - 1061}$$

Where:

- $K_n$  = High pressure steam correction factor.
- $P_1$  = Relieving pressure, psia. This is the set pressure + overpressure + atmospheric pressure.

**IV. CAPACITY CORRECTION FACTORS FOR VISCOSITY,  $K_v$**

When a liquid relief valve is required to flow a viscous fluid there may be the occasion to adjust the required orifice area for a laminar flow regime. If the Reynolds Number is less than 100,000 then there will be a viscosity correction factor,  $K_v$ . The procedure to determine the  $K_v$  factor is as follows:

**Step One**

Calculate the minimum required discharge area using the liquid sizing formula in Chapter 5 Section V. Assume the  $K_v$  factor is equal to 1.0.

**Step Two**

Select the actual orifice area that will equal or exceed the minimum area calculated in step one from an appropriate valve in Chapter 7 Section IX in square inches.

**Step Three**

Calculate the Reynolds Number.

$$R = \frac{2800V_L G}{\mu \sqrt{A'}}$$

Where:

- R = Reynolds Number
- $V_L$  = Required relieving capacity, U.S. gallons per minute at flowing temperature
- G = Specific gravity of process fluid at flowing temperature referred to water at standard conditions
- $\mu$  = Absolute viscosity at the flow temperature, centipoises
- $A'$  = Actual orifice area selected in step two

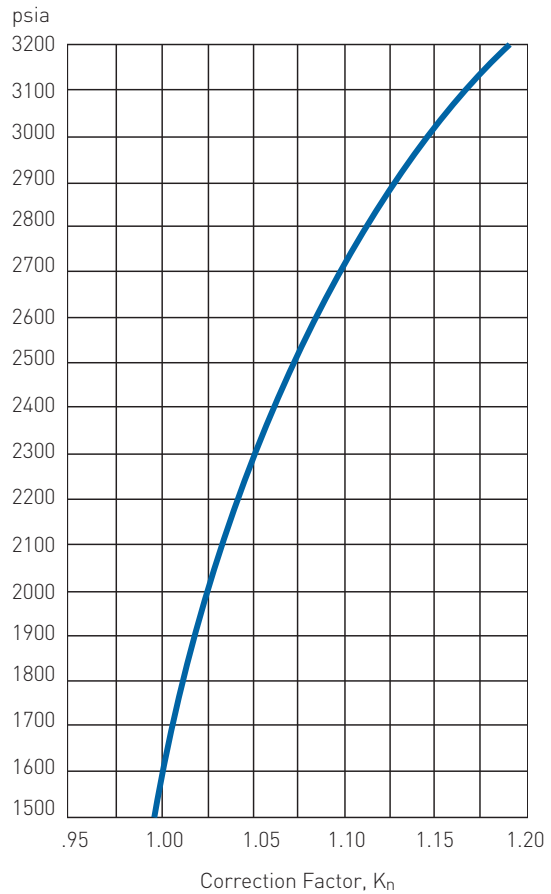
**Step Four**

Use the Reynolds Number from step three and obtain the  $K_v$  factor from Figure 7-29.

**Step Five**

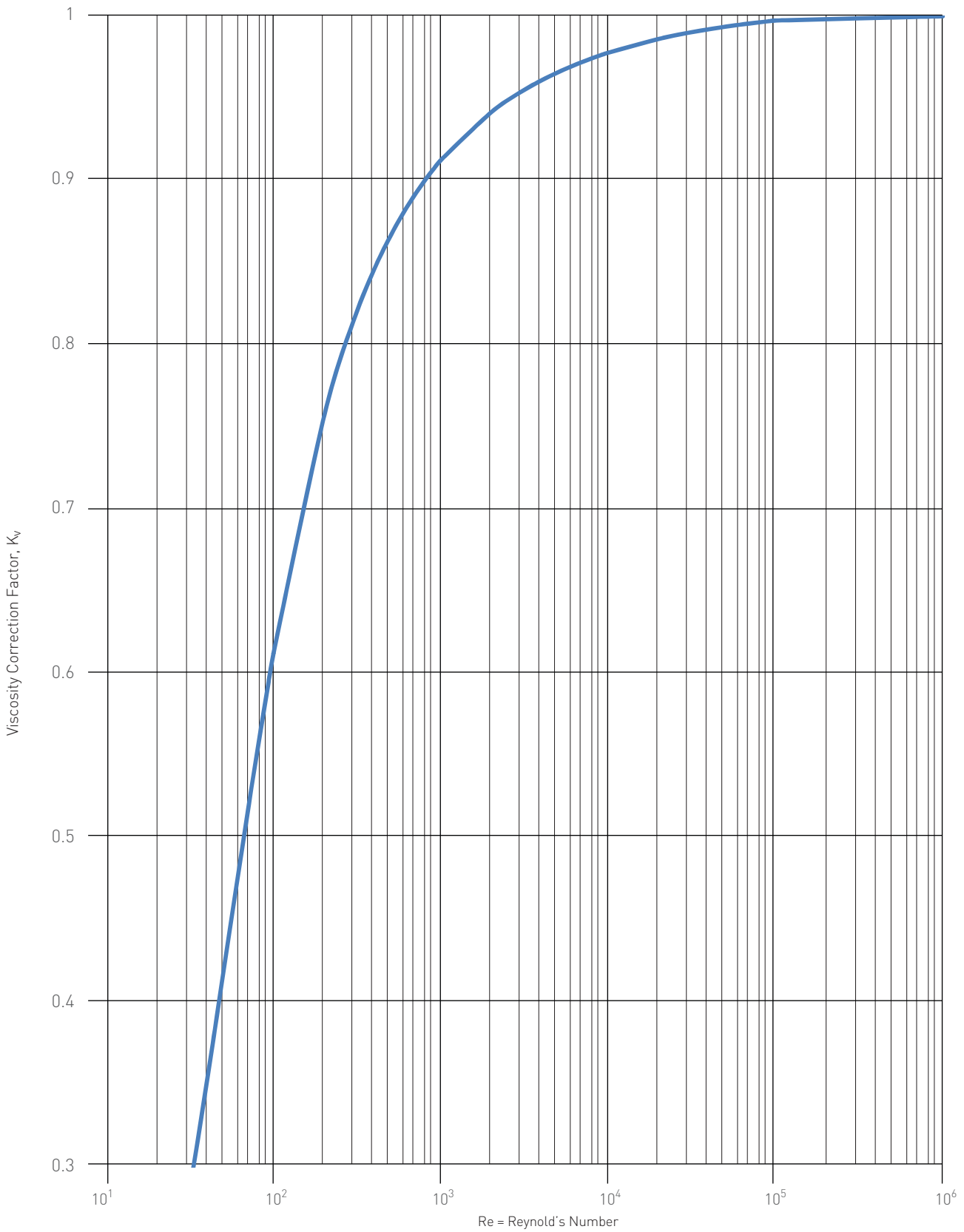
Repeat step one calculation using the  $K_v$  from step four. If the minimum required discharge area is equal to or less than the selected actual orifice area,  $A'$ , from step two, the procedure is complete. If not, chose the next largest available actual orifice area and repeat steps three through five.

FIGURE 7-28  
 Correction Factor for High Pressure Steam,  $K_n$



All Crosby steam capacity charts will reflect the  $K_n$  factor where applicable.

FIGURE 7-29  
Viscosity Correction Factor ( $K_v$ )



PRESSURE RELIEF VALVE ENGINEERING HANDBOOK  
 CHAPTER 7 - ENGINEERING SUPPORT INFORMATION - USCS UNITS (UNITED STATES CUSTOMARY SYSTEM)

**V. CAPACITY CORRECTION FACTOR FOR SUPERHEAT,  $K_{sh}$**

The steam sizing formulas are based on the flow of dry saturated steam. To size for superheated steam, the superheat correction factor is used to correct the calculated saturated steam flow to superheated steam flow. For saturated steam  $K_{sh} = 1.0$ . When the steam is superheated, enter Table 7-1 at the required relieving pressure and read the superheat correction factor under the total steam temperature column.

**TABLE 7-1 - Superheat correction factors**

Flowing pressure (psia)	Total temperature of superheated steam, °F																
	400	450	500	550	600	650	700	750	800	850	900	950	1000	1050	1100	1150	1200
50	0.987	0.957	0.930	0.905	0.882	0.861	0.841	0.823	0.805	0.789	0.774	0.759	0.745	0.732	0.719	0.708	0.696
100	0.998	0.963	0.935	0.909	0.885	0.864	0.843	0.825	0.807	0.790	0.775	0.760	0.746	0.733	0.720	0.708	0.697
150	0.984	0.970	0.940	0.913	0.888	0.866	0.846	0.826	0.808	0.792	0.776	0.761	0.747	0.733	0.721	0.709	0.697
200	0.979	0.977	0.945	0.917	0.892	0.869	0.848	0.828	0.810	0.793	0.777	0.762	0.748	0.734	0.721	0.709	0.698
250	-	0.972	0.951	0.921	0.895	0.871	0.850	0.830	0.812	0.794	0.778	0.763	0.749	0.735	0.722	0.710	0.698
300	-	0.968	0.957	0.926	0.898	0.874	0.852	0.832	0.813	0.796	0.780	0.764	0.750	0.736	0.723	0.710	0.699
350	-	0.968	0.963	0.930	0.902	0.877	0.854	0.834	0.815	0.797	0.781	0.765	0.750	0.736	0.723	0.711	0.699
400	-	-	0.963	0.935	0.906	0.880	0.857	0.836	0.816	0.798	0.782	0.766	0.751	0.737	0.724	0.712	0.700
450	-	-	0.961	0.940	0.909	0.883	0.859	0.838	0.818	0.800	0.783	0.767	0.752	0.738	0.725	0.712	0.700
500	-	-	0.961	0.946	0.914	0.886	0.862	0.840	0.820	0.801	0.784	0.768	0.753	0.739	0.725	0.713	0.701
550	-	-	0.962	0.952	0.918	0.889	0.864	0.842	0.822	0.803	0.785	0.769	0.754	0.740	0.726	0.713	0.701
600	-	-	0.964	0.958	0.922	0.892	0.867	0.844	0.823	0.804	0.787	0.770	0.755	0.740	0.727	0.714	0.702
650	-	-	0.968	0.958	0.927	0.896	0.869	0.846	0.825	0.806	0.788	0.771	0.756	0.741	0.728	0.715	0.702
700	-	-	-	0.958	0.931	0.899	0.872	0.848	0.827	0.807	0.789	0.772	0.757	0.742	0.728	0.715	0.703
750	-	-	-	0.958	0.936	0.903	0.875	0.850	0.828	0.809	0.790	0.774	0.758	0.743	0.729	0.716	0.703
800	-	-	-	0.960	0.942	0.906	0.878	0.852	0.830	0.810	0.792	0.774	0.759	0.744	0.730	0.716	0.704
850	-	-	-	0.962	0.947	0.910	0.880	0.855	0.832	0.812	0.793	0.776	0.760	0.744	0.730	0.717	0.704
900	-	-	-	0.965	0.953	0.914	0.883	0.857	0.834	0.813	0.794	0.777	0.760	0.745	0.731	0.718	0.705
950	-	-	-	0.969	0.958	0.918	0.886	0.860	0.836	0.815	0.796	0.778	0.761	0.746	0.732	0.718	0.705
1000	-	-	-	0.974	0.959	0.923	0.890	0.862	0.838	0.816	0.797	0.779	0.762	0.747	0.732	0.719	0.706
1050	-	-	-	-	0.960	0.927	0.893	0.864	0.840	0.818	0.798	0.780	0.763	0.748	0.733	0.719	0.707
1100	-	-	-	-	0.962	0.931	0.896	0.867	0.842	0.820	0.800	0.781	0.764	0.749	0.734	0.720	0.707
1150	-	-	-	-	0.964	0.936	0.899	0.870	0.844	0.821	0.801	0.782	0.765	0.749	0.735	0.721	0.708
1200	-	-	-	-	0.966	0.941	0.903	0.872	0.846	0.823	0.802	0.784	0.766	0.750	0.735	0.721	0.708
1250	-	-	-	-	0.969	0.946	0.906	0.875	0.848	0.825	0.804	0.785	0.767	0.751	0.736	0.722	0.709
1300	-	-	-	-	0.973	0.952	0.910	0.878	0.850	0.826	0.805	0.786	0.768	0.752	0.737	0.723	0.709
1350	-	-	-	-	0.977	0.958	0.914	0.880	0.852	0.828	0.807	0.787	0.769	0.753	0.737	0.723	0.710
1400	-	-	-	-	0.982	0.963	0.918	0.883	0.854	0.830	0.808	0.788	0.770	0.754	0.738	0.724	0.710
1450	-	-	-	-	0.987	0.968	0.922	0.886	0.857	0.832	0.809	0.790	0.771	0.754	0.739	0.724	0.711
1500	-	-	-	-	0.993	0.970	0.926	0.889	0.859	0.833	0.811	0.791	0.772	0.755	0.740	0.725	0.711
1550	-	-	-	-	-	0.972	0.930	0.892	0.861	0.835	0.812	0.792	0.773	0.756	0.740	0.726	0.712
1600	-	-	-	-	-	0.973	0.934	0.894	0.863	0.836	0.813	0.792	0.774	0.756	0.740	0.726	0.712
1650	-	-	-	-	-	0.973	0.936	0.895	0.863	0.836	0.812	0.791	0.772	0.755	0.739	0.724	0.710
1700	-	-	-	-	-	0.973	0.938	0.895	0.863	0.835	0.811	0.790	0.771	0.754	0.738	0.723	0.709
1750	-	-	-	-	-	0.974	0.940	0.896	0.862	0.835	0.810	0.789	0.770	0.752	0.736	0.721	0.707
1800	-	-	-	-	-	0.975	0.942	0.897	0.862	0.834	0.810	0.788	0.768	0.751	0.735	0.720	0.705
1850	-	-	-	-	-	0.976	0.944	0.897	0.862	0.833	0.809	0.787	0.767	0.749	0.733	0.718	0.704
1900	-	-	-	-	-	0.977	0.946	0.898	0.862	0.832	0.807	0.785	0.766	0.748	0.731	0.716	0.702
1950	-	-	-	-	-	0.979	0.949	0.898	0.861	0.832	0.806	0.784	0.764	0.746	0.729	0.714	0.700
2000	-	-	-	-	-	0.982	0.952	0.899	0.861	0.831	0.805	0.782	0.762	0.744	0.728	0.712	0.698

PRESSURE RELIEF VALVE ENGINEERING HANDBOOK  
 CHAPTER 7 - ENGINEERING SUPPORT INFORMATION - USCS UNITS (UNITED STATES CUSTOMARY SYSTEM)

**TABLE 7-1 - Superheat correction factors (continued)**

Flowing pressure (psia)	Total temperature of superheated steam, °F																
	400	450	500	550	600	650	700	750	800	850	900	950	1000	1050	1100	1150	1200
2050	-	-	-	-	-	0.985	0.954	0.899	0.860	0.830	0.804	0.781	0.761	0.742	0.726	0.710	0.696
2100	-	-	-	-	-	0.988	0.956	0.900	0.860	0.828	0.802	0.779	0.759	0.740	0.724	0.708	0.694
2150	-	-	-	-	-	-	0.956	0.900	0.859	0.827	0.801	0.778	0.757	0.738	0.722	0.706	0.692
2200	-	-	-	-	-	-	0.955	0.901	0.859	0.826	0.799	0.776	0.755	0.736	0.720	0.704	0.690
2250	-	-	-	-	-	-	0.954	0.901	0.858	0.825	0.797	0.774	0.753	0.734	0.717	0.702	0.687
2300	-	-	-	-	-	-	0.953	0.901	0.857	0.823	0.795	0.772	0.751	0.732	0.715	0.699	0.685
2350	-	-	-	-	-	-	0.952	0.902	0.856	0.822	0.794	0.769	0.748	0.729	0.712	0.697	0.682
2400	-	-	-	-	-	-	0.952	0.902	0.855	0.820	0.791	0.767	0.746	0.727	0.710	0.694	0.679
2450	-	-	-	-	-	-	0.951	0.902	0.854	0.818	0.789	0.765	0.743	0.724	0.707	0.691	0.677
2500	-	-	-	-	-	-	0.951	0.902	0.852	0.816	0.787	0.762	0.740	0.721	0.704	0.688	0.674
2550	-	-	-	-	-	-	0.951	0.902	0.851	0.814	0.784	0.759	0.738	0.718	0.701	0.685	0.671
2600	-	-	-	-	-	-	0.951	0.903	0.849	0.812	0.782	0.756	0.735	0.715	0.698	0.682	0.664
2650	-	-	-	-	-	-	0.952	0.903	0.848	0.809	0.779	0.754	0.731	0.712	0.695	0.679	0.664
2700	-	-	-	-	-	-	0.952	0.903	0.846	0.807	0.776	0.750	0.728	0.708	0.691	0.675	0.661
2750	-	-	-	-	-	-	0.953	0.903	0.844	0.804	0.773	0.747	0.724	0.705	0.687	0.671	0.657
2800	-	-	-	-	-	-	0.956	0.903	0.842	0.801	0.769	0.743	0.721	0.701	0.684	0.668	0.653
2850	-	-	-	-	-	-	0.959	0.902	0.839	0.798	0.766	0.739	0.717	0.697	0.679	0.663	0.649
2900	-	-	-	-	-	-	0.963	0.902	0.836	0.794	0.762	0.735	0.713	0.693	0.675	0.659	0.645
2950	-	-	-	-	-	-	-	0.902	0.834	0.790	0.758	0.731	0.708	0.688	0.671	0.655	0.640
3000	-	-	-	-	-	-	-	0.901	0.831	0.786	0.753	0.726	0.704	0.684	0.666	0.650	0.635
3050	-	-	-	-	-	-	-	0.899	0.827	0.782	0.749	0.722	0.699	0.679	0.661	0.645	0.630
3100	-	-	-	-	-	-	-	0.896	0.823	0.777	0.744	0.716	0.693	0.673	0.656	0.640	0.625
3150	-	-	-	-	-	-	-	0.894	0.819	0.772	0.738	0.711	0.688	0.668	0.650	0.634	0.620
3200	-	-	-	-	-	-	-	0.889	0.815	0.767	0.733	0.705	0.682	0.662	0.644	0.628	0.614



**VI. RATIO OF SPECIFIC HEATS, K, AND COEFFICIENT, C**

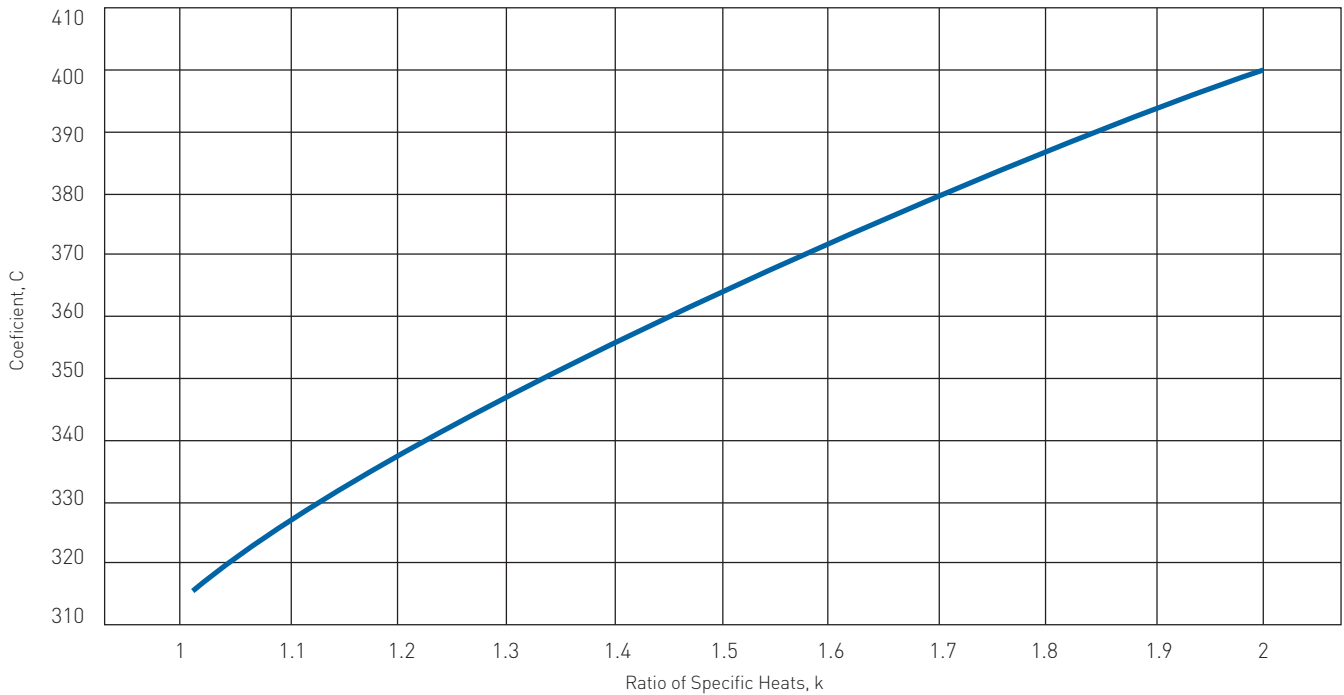
The following formula equates the ratio of specific heats (k) to the coefficient, C, used in sizing methods for gases and vapors. Figure 7-30 and Table 7-2 provide the calculated solution to this formula. If k is not known, use C = 315.

$$C = 520 \sqrt{k \left( \frac{2}{k+1} \right)^{\frac{k+1}{k-1}}}$$

Where:

k = Ratio of specific heats

FIGURE 7-30  
 Gas Constant



**TABLE 7-2 - Gas Constant Values**

k	C	k	C	k	C	k	C	k	C
1.01	317	1.21	338	1.41	357	1.61	373	1.81	388
1.02	318	1.22	339	1.42	358	1.62	374	1.82	389
1.03	319	1.23	340	1.43	359	1.63	375	1.83	389
1.04	320	1.24	341	1.44	360	1.64	376	1.84	390
1.05	321	1.25	342	1.45	360	1.65	376	1.85	391
1.06	322	1.26	343	1.46	361	1.66	377	1.86	391
1.07	323	1.27	344	1.47	362	1.67	378	1.87	392
1.08	325	1.28	345	1.48	363	1.68	379	1.88	393
1.09	326	1.29	346	1.49	364	1.69	379	1.89	393
1.10	327	1.30	347	1.50	365	1.70	380	1.90	394
1.11	328	1.31	348	1.51	365	1.71	381	1.91	395
1.12	329	1.32	349	1.52	366	1.72	382	1.92	395
1.13	330	1.33	350	1.53	367	1.73	382	1.93	396
1.14	331	1.34	351	1.54	368	1.74	383	1.94	397
1.15	332	1.35	352	1.55	369	1.75	384	1.95	397
1.16	333	1.36	353	1.56	369	1.76	384	1.96	398
1.17	334	1.37	353	1.57	370	1.77	385	1.97	398
1.18	335	1.38	354	1.58	371	1.78	386	1.98	399
1.19	336	1.39	355	1.59	372	1.79	386	1.99	400
1.20	337	1.40	356	1.60	373	1.80	387	2.00	400

PRESSURE RELIEF VALVE ENGINEERING HANDBOOK  
 CHAPTER 7 - ENGINEERING SUPPORT INFORMATION - USCS UNITS (UNITED STATES CUSTOMARY SYSTEM)

VII. TYPICAL FLUID PROPERTIES

The specific heat ratios listed herein have been obtained from numerous sources. They may vary from values available to the reader. Exercise caution when selecting the specific heat ratio.

TABLE 7-3 - Physical Properties for Selected Gases

Gas	Empirical formula	Molecular weight	Specific heat ratio	Gas constant
		M	k	C
Acetone	C <sub>3</sub> H <sub>6</sub> O	58.08	1.12	329
Acetylene (Ethyne)	C <sub>2</sub> H <sub>2</sub>	26.04	1.26	343
Air	-	28.97	1.40	356
Ammonia, Anhydrous	NH <sub>3</sub>	17.03	1.31	348
Argon	Ar	39.95	1.67	378
Benzene (Benzol or Benzole)	C <sub>6</sub> H <sub>6</sub>	78.11	1.12	329
Boron Trifluoride	BF <sub>3</sub>	67.82	1.2	337
Butadiene-1,3 (Divinyl)	C <sub>4</sub> H <sub>6</sub>	54.09	1.12	329
Butane (Normal Butane)	C <sub>4</sub> H <sub>10</sub>	58.12	1.09	326
Butylene (1-Butene)	C <sub>4</sub> H <sub>8</sub>	56.11	1.11	328
Carbon Dioxide	CO <sub>2</sub>	44.01	1.29	346
Carbon Disulfide (C. Bisulfide)	CS <sub>2</sub>	76.13	1.21	338
Carbon Monoxide	CO	28.01	1.40	356
Carbon Tetrachloride	CCl <sub>4</sub>	153.82	1.11	328
Chlorine	Cl <sub>2</sub>	70.91	1.36	353
Chloromethane (Methyl Chloride)	CH <sub>3</sub> Cl	50.49	1.28	345
Cyclohexane	C <sub>6</sub> H <sub>12</sub>	84.16	1.09	326
Cyclopropane (Trimethylene)	C <sub>3</sub> H <sub>6</sub>	42.08	1.11	328
Decane-n	C <sub>10</sub> H <sub>22</sub>	142.29	1.04	320
Diethylene Glycol (DEG)	C <sub>4</sub> H <sub>10</sub> O <sub>3</sub>	106.17	1.07	323
Diethyl Ether (Methyl Ether)	C <sub>2</sub> H <sub>6</sub> O	46.07	1.11	328
Dowtherm A	-	165.00	1.05	321
Dowtherm E	-	147.00	1.00	315
Ethane	C <sub>2</sub> H <sub>6</sub>	30.07	1.19	336
Ethyl Alcohol (Ethanol)	C <sub>2</sub> H <sub>6</sub> O	46.07	1.13	330
Ethylene (Ethene)	C <sub>2</sub> H <sub>4</sub>	28.05	1.24	341
Ethylene Glycol	C <sub>2</sub> H <sub>6</sub> O <sub>2</sub>	62.07	1.09	326
Ethylene Oxide	C <sub>2</sub> H <sub>4</sub> O	44.05	1.21	338
<b>Fluorocarbons:</b>				
12, Dichlorodifluoromethane	CCl <sub>2</sub> F <sub>2</sub>	120.93	1.14	331
13, Chlorotrifluoromethane	CClF <sub>3</sub>	104.47	1.17	334
13B1, Bromotrifluoromethane	CBrF <sub>3</sub>	148.93	1.14	331
22, Chlorodifluoromethane	CHClF <sub>2</sub>	86.48	1.18	335
115, Chloropentafluoroethane	C <sub>2</sub> ClF <sub>5</sub>	154.48	1.08	324
Glycerine (Glycerin or Glycerol)	C <sub>3</sub> H <sub>8</sub> O <sub>3</sub>	92.10	1.06	322

PRESSURE RELIEF VALVE ENGINEERING HANDBOOK  
 CHAPTER 7 - ENGINEERING SUPPORT INFORMATION - USCS UNITS (UNITED STATES CUSTOMARY SYSTEM)

**TABLE 7-3 - Physical properties for selected gases (continued)**

Gas	Empirical formula	Molecular weight M	Specific heat ratio k	Gas constant C
Helium	He	4.00	1.67	378
Heptane	C <sub>7</sub> H <sub>16</sub>	100.21	1.05	321
Hexane	C <sub>6</sub> H <sub>14</sub>	86.18	1.06	322
Hydrogen	H <sub>2</sub>	2.02	1.41	357
Hydrogen Chloride, Anhydrous	HCl	36.46	1.41	357
Hydrogen Sulfide	H <sub>2</sub> S	34.08	1.32	349
Isobutane [2-Methylpropane]	C <sub>4</sub> H <sub>10</sub>	58.12	1.10	327
Isobutane [2-Methyl-1,3butadiene]	C <sub>5</sub> H <sub>8</sub>	68.12	1.09	326
Isopropyl Alcohol [Isopropanol]	C <sub>3</sub> H <sub>8</sub> O	60.10	1.09	326
Krypton	Kr	83.80	1.71	380
Methane	CH <sub>4</sub>	16.04	1.31	348
Methyl Alcohol [Methanol]	CH <sub>4</sub> O	32.04	1.20	337
<b>Methylanmines, Anhydrous:</b>				
Monomethylamine (Methylamine)	CH <sub>5</sub> N	31.06	1.02	317
Dimethylamine	C <sub>2</sub> H <sub>7</sub> N	45.08	1.15	332
Triethylamine	C <sub>3</sub> H <sub>9</sub> N	59.11	1.18	335
Methyl Mercaptan (Methylamine)	CH <sub>4</sub> S	48.11	1.20	337
Naphthalene [Naphthaline]	C <sub>10</sub> H <sub>8</sub>	128.17	1.07	323
Natural Gas (Relative Density = 0.60)	-	17.40	1.27	344
Neon	Ne	20.18	1.64	375
Nitrogen	N <sub>2</sub>	28.01	1.40	356
Nitrous Oxide	N <sub>2</sub> O	44.01	1.30	347
Octane	C <sub>8</sub> H <sub>18</sub>	114.23	1.05	321
Oxygen	O <sub>2</sub>	32.00	1.40	356
Pentane	C <sub>5</sub> H <sub>12</sub>	72.15	1.07	323
Propadiene (Allene)	C <sub>3</sub> H <sub>4</sub>	40.07	1.69	379
Propane	C <sub>3</sub> H <sub>8</sub>	44.10	1.13	330
Propylene (Propene)	C <sub>3</sub> H <sub>6</sub>	42.08	1.15	332
Propylene Oxide	C <sub>3</sub> H <sub>6</sub> O	58.08	1.13	330
Styrene	C <sub>8</sub> H <sub>8</sub>	104.15	1.07	323
Sulfur Dioxide	SO <sub>2</sub>	64.06	1.28	345
Sulfur Hexafluoride	SF <sub>6</sub>	146.05	1.09	326
Steam	H <sub>2</sub> O	18.02	1.31	348
Toluene (Toluol or Methylbenzene)	C <sub>7</sub> H <sub>8</sub>	92.14	1.09	326
Triethylene Glycol (TEG)	C <sub>6</sub> H <sub>14</sub> O <sub>4</sub>	150.18	1.04	320
Vinyl Chloride Monomer (VCM)	C <sub>2</sub> H <sub>3</sub> Cl	62.50	1.19	336
Xenon	Xe	131.30	1.65	376
Xylene (p-Xylene)	C <sub>8</sub> H <sub>10</sub>	106.17	1.07	323

PRESSURE RELIEF VALVE ENGINEERING HANDBOOK  
 CHAPTER 7 - ENGINEERING SUPPORT INFORMATION - USCS UNITS (UNITED STATES CUSTOMARY SYSTEM)

**TABLE 7-4 - Physical Properties for Selected Liquids**

Fluid	Empirical Formula	Relative Density G	Fluid Temperature
		Water = 1	°F
Acetaldehyde	C <sub>2</sub> H <sub>4</sub>	0.779	68
Acetic Acid	C <sub>2</sub> H <sub>4</sub> O <sub>2</sub>	1.051	68
Acetone	C <sub>3</sub> H <sub>6</sub> O	0.792	68
Ammonia, Anhydrous	NH <sub>3</sub>	0.666	68
<b>Automotive Crankcase and Gear Oils:</b>			
SAE-5W Through SAE 150	-	0.88-0.94	60
Beer	-	1.01	60
Benzene (Benzol)	C <sub>6</sub> H <sub>6</sub>	0.880	68
Boron Trifluoride	BF <sub>3</sub>	1.57	-148
Butadiene-1,3	C <sub>4</sub> H <sub>6</sub>	0.622	68
Butane-n (Normal Butane)	C <sub>4</sub> H <sub>10</sub>	0.579	68
Butylene (1-Butene)	C <sub>4</sub> H <sub>8</sub>	0.600	68
Carbon Dioxide	CO <sub>2</sub>	1.03	-4
Carbon Disulphide (C. Bisulphide)	CS <sub>2</sub>	1.27	68
Carbon Tetrachloride	CCl <sub>4</sub>	1.60	68
Chlorine	Cl <sub>2</sub>	1.42	68
Chloromethane (Methyl Chloride)	CH <sub>3</sub> Cl	0.921	68
<b>Crude Oils:</b>			
32.6 Deg API	-	0.862	60
35.6 Deg API	-	0.847	60
40 Deg API	-	0.825	60
48 Deg API	-	0.79	60
Cyclohexane	C <sub>6</sub> H <sub>12</sub>	0.780	68
Cyclopropane (Trimethylene)	C <sub>3</sub> H <sub>6</sub>	0.621	68
Decane-n	C <sub>10</sub> H <sub>22</sub>	0.731	68
Diesel Fuel Oils	-	0.82-0.95	60
Diethylene Glycol (DEG)	C <sub>4</sub> H <sub>10</sub> O <sub>3</sub>	1.12	68
Dimethyl Ether (Methyl Ether)	C <sub>2</sub> H <sub>6</sub> O	0.663	68
Dowtherm A	-	0.998	68
Dowtherm E	-	1.087	68
Ethane	C <sub>2</sub> H <sub>6</sub>	0.336	68
Ethyl Alcohol (Ethanol)	C <sub>2</sub> H <sub>6</sub> O	0.79	68
Ethylene (Ethene)	C <sub>2</sub> H <sub>4</sub>	0.569	-155
Ethylene Glycol	C <sub>2</sub> H <sub>6</sub> O <sub>2</sub>	1.115	68
Ethylene Oxide	C <sub>2</sub> H <sub>4</sub> O	0.901	68
<b>Fluorocarbons:</b>			
R12, Dichlorodifluoromethane	CCl <sub>2</sub> F <sub>2</sub>	1.34	68
R13, Chlorotrifluoromethane	CClF <sub>3</sub>	0.916	68
R13B1, Bromotrifluoromethane	CBrF <sub>3</sub>	1.58	68
R22, Chlorodifluoromethane	CHClF <sub>2</sub>	1.21	68
R115, Chloropentafluoroethane	C <sub>2</sub> ClF <sub>5</sub>	1.31	68

PRESSURE RELIEF VALVE ENGINEERING HANDBOOK  
 CHAPTER 7 - ENGINEERING SUPPORT INFORMATION - USCS UNITS (UNITED STATES CUSTOMARY SYSTEM)

**TABLE 7-4 - Physical Properties for Selected Liquids (continued)**

Fluid	Empirical formula	Relative Density G:	Fluid Temperature
		Water = 1	°F
Fuel Oils, Nos. 1, 2, 3, 5 and 6	-	0.82-0.95	60
Gasolines	-	0.68-0.74	60
Glycerine (Glycerin or Glycerol)	C <sub>3</sub> H <sub>8</sub> O <sub>3</sub>	1.26	68
Heptane	C <sub>7</sub> H <sub>16</sub>	0.685	68
Hexane	C <sub>6</sub> H <sub>14</sub>	0.660	68
Hydrochloric Acid	HCl	1.64	60
Hydrogen Sulphide	H <sub>2</sub> S	0.78	68
Isobutane [2-Methylpropane]	C <sub>4</sub> H <sub>10</sub>	0.558	68
Isoprene [2-Methyl-1,3-Butadiene]	C <sub>5</sub> H <sub>8</sub>	0.682	68
Isopropyl Alcohol (Isopropanol)	C <sub>3</sub> H <sub>8</sub> O	0.786	68
Jet Fuel (average)	-	0.82	60
Kerosene	-	0.78-0.82	60
Methyl Alcohol (Methanol)	CH <sub>4</sub> O	0.792	68
<b>Methylamines, Anhydrous:</b>			
Monomethylamine (Methylamine)	CH <sub>5</sub> N	0.663	68
Dimethylamine	C <sub>2</sub> H <sub>7</sub> N	0.656	68
Trimethylamine	C <sub>3</sub> H <sub>9</sub> N	0.634	68
Methyl Mercaptan (Methanethiol)	CH <sub>4</sub> S	0.870	68
Nitric Acid	HNO <sub>3</sub>	1.5	60
Nitrous Oxide	N <sub>2</sub> O	1.23	-127
Octane	C <sub>8</sub> H <sub>18</sub>	0.703	68
Pentane	C <sub>5</sub> H <sub>12</sub>	0.627	68
Propadiene (Allene)	C <sub>3</sub> H <sub>4</sub>	0.659	-30
Propane	C <sub>3</sub> H <sub>8</sub>	0.501	68
Propylene (Propene)	C <sub>3</sub> H <sub>6</sub>	0.514	68
Propylene Oxide	C <sub>3</sub> H <sub>6</sub> O	0.830	68
Styrene	C <sub>8</sub> H <sub>8</sub>	0.908	68
Sulfur Dioxide	SO <sub>2</sub>	1.43	68
Sulphur Hexafluoride	SF <sub>6</sub>	1.37	68
<b>Sulphur Acid:</b>			
95-100%	-	1.839	68
60%	-	1.50	68
20%	-	1.14	68
Toluene (Toluol or Methylbenzene)	C <sub>7</sub> H <sub>8</sub>	0.868	68
Triethylene Glycol (TEG)	C <sub>6</sub> H <sub>12</sub> O <sub>4</sub>	1.126	68
Vinyl Chloride Monomer (VCM)	C <sub>2</sub> H <sub>3</sub> Cl	0.985	-4
Water, fresh	H <sub>2</sub> O	1.00	68
Water, sea	-	1.03	68
Xylene (p-Xylene)	C <sub>8</sub> H <sub>10</sub>	0.862	68

VIII. SATURATED STEAM PRESSURE TABLE

TABLE 7-5 - Saturation Pressure (psia)/Temperature (°F)

Pressure psia	Temperature deg F	Pressure psia	Temperature deg F
14.7	212.0	520	471.1
15	213.3	540	475.0
20	228.0	560	478.8
25	240.1	580	482.6
30	250.3	600	486.2
35	259.3	620	489.7
40	267.3	640	493.2
45	274.4	660	496.6
50	281.0	680	499.9
55	287.1	700	503.1
60	292.7	720	506.2
65	298.0	740	509.3
70	302.9	760	512.3
75	307.6	780	515.3
80	312.0	800	518.2
85	316.3	820	521.1
90	320.3	840	523.9
95	324.1	860	526.6
100	327.8	880	529.3
105	331.4	900	532.0
110	334.8	920	534.6
115	338.1	940	537.1
120	341.3	960	539.7
125	344.4	980	542.1
130	347.3	1000	544.6
135	350.2	1050	550.5
140	353.0	1100	556.3
145	355.8	1150	561.8
150	358.4	1200	567.2
160	363.6	1250	572.4
170	368.4	1300	577.4
180	373.1	1350	582.3
190	377.5	1400	587.1
200	381.8	1450	591.7
210	385.9	1500	596.2
220	389.9	1600	604.9
230	393.7	1700	613.1
240	397.4	1800	621.0
250	401.0	1900	628.6
260	404.4	2000	635.8
270	407.8	2100	642.8
280	411.1	2200	649.6
290	414.3	2300	655.9
300	417.4	2400	662.1
320	423.3	2500	668.1
340	429.0	2600	673.9
360	434.9	2700	679.5
380	439.6	2800	685.0
400	444.6	2900	690.2
420	449.4	3000	695.3
440	454.0	3100	700.3
460	458.5	3200	705.1
480	462.8	3208	705.5
500	467.0		

## IX. ANDERSON GREENWOOD AND CROSBY PRESSURE RELIEF VALVES

---

### Orifice Area and Coefficient of Discharge

As mentioned in Chapter Three, the use of the proper orifice area (A) and coefficient of discharge (K) in the sizing formulas presented in this handbook are critical to determining the correct valve size. For some valve designs, two sets of values are published.

One set, the effective area and effective coefficient of discharge, are published by API in Standard 526, Flanged Steel Pressure Relief Valves and Standard 520 part I, Sizing, Selection and Installation of Pressure Relieving Devices. These values are independent of any specific valve design and are used to determine a preliminary pressure relief valve size.

Where applicable, a second set of areas and discharge coefficients is shown to determine the "rated" capacity of a valve using the "actual" orifice area and "rated" coefficient of discharge.

Rated coefficients are established by regulatory bodies like ASME and "actual" areas are published by the manufacturer.

It is important to remember that the effective area and effective coefficient of discharge are used only for the initial selection. The actual orifice area and rated coefficient of discharge must always be used to verify the actual capacity of the pressure relief valve.

*In no case should an effective area or effective coefficient of discharge be used with actual area or rated coefficient of discharge. Sizing errors can be made if the effective values are mixed with the actual values.*

The following tables provide orifice areas and coefficient of discharge for Anderson Greenwood and Crosby pressure relief valves. Once again, where applicable, there is a table with API "effective" values and a separate table with ASME "rated" and "actual" values.

*Do not mix values from these tables.*

**TABLE 7-6 - JOS-E/JBS-E/JLT-E Full Nozzle Direct Acting Spring Valves**

API Effective Orifice Area and Coefficient of Discharge					
Minimum inlet size	Orifice designation	Gas (in <sup>2</sup> )		Liquid (in <sup>2</sup> )	Steam (in <sup>2</sup> )
		Series		Series	Series
		JOS-E, JBS-E, JLT-JOS-E, JLT-JBS-E K = 0.975		JLT-JOS-E, JLT-JBS-E K = 0.650	JOS-E, JBS-E K = 0.975
1"	D		0.110	0.110	0.110
1"	E		0.196	0.196	0.196
1.5"	F		0.307	0.307	0.307
1.5"	G		0.503	0.503	0.503
1.5"	H		0.785	0.785	0.785
2"	J		1.287	1.287	1.287
3"	K		1.838	1.838	1.838
3"	L		2.853	2.853	2.853
4"	M		3.600	3.600	3.600
4"	N		4.340	4.340	4.340
4"	P		6.380	6.380	6.380
6"	Q		11.050	11.050	11.050
6"	R		16.000	16.000	16.000
8"	T		26.000	26.000	26.000

**TABLE 7-7 - JOS-E/JBS-E/JLT-E Full Nozzle Direct Acting Spring Valves**

ASME Actual Orifice Area and Rated Coefficient of Discharge					
Minimum inlet size	Orifice designation	Air/gas (in <sup>2</sup> )		Liquid (in <sup>2</sup> )	Steam (in <sup>2</sup> )
		Series		Series	Series
		JOS-E, JBS-E K = 0.865		JLT-JOS-E, JLT-JBS-E K = 0.870	JLT-JOS-E, JLT-JBS-E K = 0.656
1"	D		0.124	0.124	0.124
1"	E		0.221	0.221	0.221
1.5"	F		0.347	0.347	0.347
1.5"	G		0.567	0.567	0.567
1.5"	H		0.887	0.887	0.887
2"	J		1.453	1.453	1.453
3"	K		2.076	2.076	2.076
3"	L		3.221	3.221	3.221
4"	M		4.065	4.065	4.065
4"	N		4.900	4.900	4.900
4"	P		7.206	7.206	7.206
6"	Q		12.470	12.470	12.470
6"	R		18.060	18.060	18.060
8"	T		29.360	29.360	29.360
8"	T2		31.470	31.470	31.470



**TABLE 7-8 - OMNI 800/900/BP Portable Direct Acting Spring Valves**

Minimum Inlet Size		Orifice Designation		ASME Actual Orifice Area and Rated Coefficient of Discharge							
				Gas (in <sup>2</sup> )			Liquid (in <sup>2</sup> )		Steam (in <sup>2</sup> )		
				Section VIII			Section VIII		Section VIII		
		Series 800 K = 0.877	Series 900 K = 0.878	Series BP K = 0.841	Series 900 K = 0.662	Series BP K = 0.631	Series 800 K = 0.877	Series 900 K = 0.878			
1/2"	-5	-	0.085	-	0.085	-	-	0.085			
1/2"	-6	-	0.124	-	0.124	-	-	0.124			
3/4"	-5	-	-	0.093	-	0.093	-	-			
3/4"	-6	0.124	-	0.136	-	0.136	0.124	-			
1"	-7	0.220	0.220	-	0.220	-	0.220	0.220			
1.5"	-8	0.344	0.347	-	0.347	-	0.344	0.347			
1.5"	-9	0.567	0.567	-	0.567	-	0.567	0.567			

**TABLE 7-9 - Series 60 and Series 80 Portable Direct Acting Spring Valves**

Minimum Inlet Size		Orifice Designation		ASME Actual Orifice Area and Rated Coefficient of Discharge							
				Gas (in <sup>2</sup> )				Liquid (in <sup>2</sup> )	Steam (in <sup>2</sup> )		
				Section VIII				Section VIII	Section VIII		
		81/83 K = 0.816	81P K = 0.816	61 K = 0.877	63B K = 0.847	81P K = 0.720	86 K = 0.816				
1/2"	-4	0.049	-	-	-	-	0.049				
1/2"	-5	-	-	-	0.076	-	-				
1/2"	-6	0.110	-	0.110	-	-	-				
3/4"	-4	-	-	-	-	0.049	0.049				
3/4"	-7	-	-	-	0.149	-	-				
3/4"	-8	0.196	0.196	-	-	0.196	0.196				
1.5"	F	0.307	-	-	-	-	-				
1.5"	G	0.503	-	-	-	0.503	0.503				
2"	H	0.785	-	-	-	-	-				
2"	J	1.287	-	-	-	1.287	1.287				

**TABLE 7-10 - H SERIES DIRECT ACTING SPRING SAFETY VALVES**

		ASME Actual Orifice Area and Rated Coefficient of Discharge		
		Steam (in <sup>2</sup> )		
		Section I/Section VIII		
Minimum Inlet size	Orifice Designation	HSJ	HCI	HE
		K = 0.878	ISO FLEX K = 0.878	ISO FLEX K = 0.877
1.25"	F	-	-	-
1.25"	G	-	-	-
1.5"	F	0.307	-	-
1.5"	G	0.503	-	-
1.5"	H	0.785	-	-
1.5"	H2	-	0.994	-
1.5"	J	-	-	-
2"	H	0.785	-	-
2"	J	1.288	-	-
2"	J2	-	1.431	-
2"	K	-	-	-
2.5"	K	1.840	-	1.840
2.5"	K2	-	2.545	2.545
2.5"	L	-	-	-
3"	K	1.840	-	-
3"	L	2.853	-	-
3"	L2	-	3.341	-
3"	M	3.600	-	3.600
3"	M <sup>2</sup>	-	3.976	3.976
4"	N	4.341	-	-
4"	P	6.380	-	-
4"	P2	-	7.070	7.069
6"	Q	11.040	-	-
6"	Q2	-	12.250	-
6"	R	-	16.000	-
6"	RR	-	19.290	-

**TABLE 7-11 - High Pressure Pilot Operated Valves**

		API Effective Orifice Area and Coefficient of Discharge						
		Gas (in <sup>2</sup> )			Liquid (in <sup>2</sup> )		Steam (in <sup>2</sup> )	
		Series			Series		Series	
Minimum Inlet size	Orifice Designation	200/400/800	500	727	400/800	500	500	727
		K = 0.975	K = 0.975	K = 0.975	K = 0.650	K = 0.650	K = 0.975	K = 0.975
1"	D	0.110	-	-	0.110	-	-	-
1"	E	0.196	-	-	0.196	-	-	-
1"	F	0.307	0.307	-	0.307	0.307	0.785	-
1.5"	G	0.503	-	-	0.503	-	-	-
1.5"	H	0.785	0.785	-	0.785	0.785	0.785	-
2"	G	0.503	-	0.503	0.503	-	-	0.503
2"	H	0.785	-	0.785	0.785	-	-	0.785
2"	J	1.287	1.287	1.287	1.287	1.287	1.287	1.287
3"	K	1.838	-	1.838	1.838	-	-	1.838
3"	L	2.853	2.853	2.853	2.853	2.853	2.853	2.853
4"	M	3.600	-	3.600	3.600	-	-	3.600
4"	N	4.340	-	4.340	4.340	-	-	4.340
4"	P	6.380	6.380	6.380	6.380	6.380	6.380	6.380
6"	Q	11.050	-	11.050	11.050	-	-	11.050
6"	R	16.000	16.000	16.000	16.000	16.000	16.000	16.000
8"	T	26.000	26.000	26.000	26.000	26.000	26.000	26.000

PRESSURE RELIEF VALVE ENGINEERING HANDBOOK  
 CHAPTER 7 - ENGINEERING SUPPORT INFORMATION - USCS UNITS (UNITED STATES CUSTOMARY SYSTEM)

**TABLE 7-12 - High Pressure Pilot Operated Valves**

ASME Actual Orifice Area and Rated Coefficient of Discharge										
Min. Inlet Size	Orifice Designation	Gas				Liquid		Steam		Economizer
		Section VIII				Section VIII		Section VIII		Section I
		200/400/800	500	LCP	727	400/800	500	500	727	5100
1"	D	A = 0.205 in <sup>2</sup> K = 0.627	-	-	-	A = 0.221 in <sup>2</sup> K = 0.491	-	-	-	-
1"	E	A = 0.356 in <sup>2</sup> K = 0.627	-	-	-	A = 0.356 in <sup>2</sup> K = 0.491	-	-	-	-
1"	F	A = 0.357 in <sup>2</sup> K = 0.877	A = 0.357 in <sup>2</sup> K = 0.877	-	-	A = 0.357 in <sup>2</sup> K = 0.766	A = 0.357 in <sup>2</sup> K = 0.766	A = 0.357 in <sup>2</sup> K = 0.877	-	A = 0.357 in <sup>2</sup> K = 0.876 (steam)
1"	-	-	-	A = 0.785 in <sup>2</sup> K = 0.860	-	-	-	-	K = 0.759 (water)	-
1.5"	G	A = 0.831 in <sup>2</sup> K = 0.627	-	-	-	A = 0.911 in <sup>2</sup> K = 0.491	-	-	-	-
1.5"	H	A = 0.913 in <sup>2</sup> K = 0.877	A = 0.913 in <sup>2</sup> K = 0.877	-	-	A = 0.913 in <sup>2</sup> K = 0.766	A = 0.913 in <sup>2</sup> K = 0.766	A = 0.913 in <sup>2</sup> K = 0.877	-	A = 0.913 in <sup>2</sup> K = 0.876 (steam) K = 0.759 (water)
1.5"	-	-	-	A = 1.767 in <sup>2</sup> K = 0.860	-	-	-	-	-	-
1.5"	FB	A = 1.496 in <sup>2</sup> K = 0.860	A = 1.496 in <sup>2</sup> K = 0.860	-	-	A = 1.496 in <sup>2</sup> K = 0.712	A = 1.496 in <sup>2</sup> K = 0.712	A = 1.496 in <sup>2</sup> K = 0.860	-	A = 1.496 in <sup>2</sup> K = 0.849 (steam) K = 0.709 (water)
2"	G	A = 0.850 in <sup>2</sup> K = 0.627	-	-	A = 0.629 in <sup>2</sup> K = 0.788	A = 1.005 in <sup>2</sup> K = 0.491	-	-	A = 0.629 in <sup>2</sup> K = 0.788	-
2"	H	A = 1.312 in <sup>2</sup> K = 0.627	-	-	A = 0.981 in <sup>2</sup> K = 0.788	A = 1.495 in <sup>2</sup> K = 0.491	-	-	A = 0.981 in <sup>2</sup> K = 0.788	-
2"	J	A = 1.496 in <sup>2</sup> K = 0.877	A = 1.496 in <sup>2</sup> K = 0.877	-	A = 1.635 in <sup>2</sup> K = 0.788	A = 1.496 in <sup>2</sup> K = 0.766	A = 1.496 in <sup>2</sup> K = 0.766	A = 1.496 in <sup>2</sup> K = 0.877	A = 1.635 in <sup>2</sup> K = 0.788	A = 1.496 in <sup>2</sup> K = 0.876 (steam) K = 0.759 (water)
2"	-	-	-	A = 3.142 in <sup>2</sup> K = 0.860	-	-	-	-	-	-
2"	FB	A = 2.895 in <sup>2</sup> K = 0.860	A = 2.895 in <sup>2</sup> K = 0.860	-	-	A = 2.895 in <sup>2</sup> K = 0.712	A = 2.895 in <sup>2</sup> K = 0.712	A = 2.895 in <sup>2</sup> K = 0.860	-	A = 2.895 in <sup>2</sup> K = 0.849 (steam) K = 0.709 (water)
3"	J	A = 2.132 in <sup>2</sup> K = 0.627	-	-	-	A = 2.574 in <sup>2</sup> K = 0.491	-	-	-	-
3"	K	A = 3.043 in <sup>2</sup> K = 0.627	-	-	A = 2.298 in <sup>2</sup> K = 0.788	A = 3.313 in <sup>2</sup> K = 0.491	-	-	A = 2.298 in <sup>2</sup> K = 0.788	-
3"	L	A = 3.317 in <sup>2</sup> K = 0.877	A = 3.317 in <sup>2</sup> K = 0.877	-	A = 3.557 in <sup>2</sup> K = 0.788	A = 3.317 in <sup>2</sup> K = 0.766	-	A = 3.317 in <sup>2</sup> K = 0.877	A = 3.557 in <sup>2</sup> K = 0.788	A = 3.317 in <sup>2</sup> K = 0.876 (steam) K = 0.759 (water)
3"	-	-	-	A = 7.069 in <sup>2</sup> K = 0.860	-	-	-	-	-	-
3"	FB	A = 6.733 in <sup>2</sup> K = 0.860	A = 6.733 in <sup>2</sup> K = 0.860	-	-	A = 6.733 in <sup>2</sup> K = 0.712	A = 6.733 in <sup>2</sup> K = 0.712	A = 6.733 in <sup>2</sup> K = 0.860	-	A = 6.733 in <sup>2</sup> K = 0.849 (steam) K = 0.709 (water)
4"	L	A = 4.729 in <sup>2</sup> K = 0.627	-	-	-	A = 5.711 in <sup>2</sup> K = 0.491	-	-	-	-
4"	M	A = 5.959 in <sup>2</sup> K = 0.627	-	-	A = 4.505 in <sup>2</sup> K = 0.788	A = 6.385 in <sup>2</sup> K = 0.491	-	-	A = 4.505 in <sup>2</sup> K = 0.788	-
4"	N	A = 7.188 in <sup>2</sup> K = 0.627	-	-	A = 5.425 in <sup>2</sup> K = 0.788	A = 7.059 in <sup>2</sup> K = 0.491	-	-	A = 5.425 in <sup>2</sup> K = 0.788	-
4"	P	A = 7.645 in <sup>2</sup> K = 0.877	A = 7.645 in <sup>2</sup> K = 0.877	-	A = 7.911 in <sup>2</sup> K = 0.788	A = 7.069 in <sup>2</sup> K = 0.766	A = 7.069 in <sup>2</sup> K = 0.766	A = 7.645 in <sup>2</sup> K = 0.877	A = 7.911 in <sup>2</sup> K = 0.788	-
4"	FB	A = 10.75 in <sup>2</sup> K = 0.860	A = 10.75 in <sup>2</sup> K = 0.860	-	-	A = 10.75 in <sup>2</sup> K = 0.712	A = 10.75 in <sup>2</sup> K = 0.712	A = 10.75 in <sup>2</sup> K = 0.860	-	A = 10.75 in <sup>2</sup> K = 0.849 (steam) K = 0.709 (water)

PRESSURE RELIEF VALVE ENGINEERING HANDBOOK  
 CHAPTER 7 - ENGINEERING SUPPORT INFORMATION - USCS UNITS (UNITED STATES CUSTOMARY SYSTEM)

**TABLE 7-12 - High Pressure Pilot Operated Valves (continued)**

ASME Actual Orifice Area and Rated Coefficient of Discharge										
Min. Inlet Size	Orifice Designation	Gas				Liquid		Steam		Economizer
		Section VIII				Section VIII		Section VIII		Section I
		200/400/800	500	LCP	727	400/800	500	500	727	5100
6"	Q	A = 18.294 in <sup>2</sup> K = 0.627	-	-	A = 13.81 in <sup>2</sup> K = 0.788	A = 15.88 in <sup>2</sup> K = 0.491	-	-	A = 13.81 in <sup>2</sup> K = 0.788	-
6"	R	A = 18.597 in <sup>2</sup> K = 0.877	A = 18.597 in <sup>2</sup> K = 0.877	-	A = 20.00 in <sup>2</sup> K = 0.788	A = 15.90 in <sup>2</sup> K = 0.766	A = 15.90 in <sup>2</sup> K = 0.766	A = 18.59 in <sup>2</sup> K = 0.877	A = 20.00 in <sup>2</sup> K = 0.788	-
6"	FB	A = 23.32 in <sup>2</sup> K = 0.860	A = 23.32 in <sup>2</sup> K = 0.860	-	-	A = 23.32 in <sup>2</sup> K = 0.712	A = 23.32 in <sup>2</sup> K = 0.712	A = 23.32 in <sup>2</sup> K = 0.860	-	A = 23.32 in <sup>2</sup> K = 0.849 (steam) K = 0.709 (water)
8"	T	A = 30.58 in <sup>2</sup> K = 0.877	A = 30.58 in <sup>2</sup> K = 0.877	-	A = 32.50 in <sup>2</sup> K = 0.788	A = 28.27 in <sup>2</sup> K = 0.766	A = 28.27 in <sup>2</sup> K = 0.766	A = 30.58 in <sup>2</sup> K = 0.877	A = 32.50 in <sup>2</sup> K = 0.788	-
8"	8FB 8x8	A = 32.17 in <sup>2</sup> K = 0.860	A = 32.17 in <sup>2</sup> K = 0.860	-	-	A = 31.17 in <sup>2</sup> K = 0.712	A = 31.17 in <sup>2</sup> K = 0.712	A = 32.17 in <sup>2</sup> K = 0.860	-	-
8"	8FB 10	A = 44.18 in <sup>2</sup> K = 0.860	A = 44.18 in <sup>2</sup> K = 0.860	-	-	A = 44.18 in <sup>2</sup> K = 0.712	A = 44.18 in <sup>2</sup> K = 0.712	A = 44.18 in <sup>2</sup> K = 0.860	-	A = 44.18 in <sup>2</sup> K = 0.849 (steam) K = 0.709 (water)
10"	FB	A = 72.01 in <sup>2</sup> K = 0.860	A = 72.01 in <sup>2</sup> K = 0.860	-	-	-	-	A = 72.01 in <sup>2</sup> K = 0.860	-	-

**TABLE 7-13 - LOW PRESSURE PILOT OPERATED VALVES**

ASME Actual Orifice Area and Rated Coefficient of Discharge (Set pressure ≥15 psig)					
Min. Inlet Size	Orifice Designation	Gas (in <sup>2</sup> )			
		91/94 K = 0.770	93 K = 0.845	95 K = 0.852	9300 K = 0.629
2"	*	2.924	2.290	2.926	3.350
3"	*	6.243	5.160	6.246	7.390
4"	*	10.330	8.740	10.320	12.730
6"	*	22.220	19.560	22.150	28.890
8"	*	39.570	36.400	-	50.000
10"	*	56.750	51.000	-	78.850
12"	*	89.870	84.000	-	113.000

**TABLE 7-14 - LOW PRESSURE PILOT OPERATED VALVES**

Actual Orifice Area and Rated Coefficient of Discharge (Set pressure < 15 psig)						
Min. Inlet Size	Orifice Designation	Gas (in <sup>2</sup> )				
		91/94 K <sub>d</sub> = 0.678 (P <sub>2</sub> /P <sub>1</sub> )-0.285	93 K <sub>d</sub> = 0.700 (P <sub>1</sub> /P <sub>2</sub> )-0.265	95 K <sub>d</sub> = 0.678 (P <sub>1</sub> /P <sub>2</sub> )-0.285	9200 K <sub>d</sub> = 0.756 (P <sub>1</sub> /P <sub>2</sub> ) 0.0517	9300 K <sub>d</sub> = 0.650 (P <sub>1</sub> /P <sub>2</sub> ) -0.349
2"	*	2.924	2.290	2.926	3.350	3.350
3"	*	6.243	5.160	6.246	7.390	7.390
4"	*	10.330	8.740	10.320	12.730	12.730
6"	*	22.220	19.560	22.150	28.890	28.890
8"	*	39.570	36.400	-	50.000	50.000
10"	*	56.750	51.000	-	78.850	78.850
12"	*	89.870	84.000	-	113.000	113.000

\* Full bore

Where:

P<sub>2</sub> = Pressure at valve outlet during flow, psia. This is total back pressure (psig) + atmospheric pressure (psia).

P<sub>1</sub> = Relieving pressure, psia. This is the set pressure (psig) + overpressure (psig) + atmospheric pressure (psia) - inlet pressure piping loss (psig).

P<sub>A</sub> = Atmospheric pressure (psia).

**TABLE 7-15 - Low Pressure Pilot Operated Valves**

Actual Orifice Area and Rated Coefficient of Discharge - Vacuum Flow		Air/Gas (in <sup>2</sup> )	
Minimum Inlet Size	Orifice Designation	9200	9300
		K <sub>d</sub> = 0.667	K <sub>d</sub> = 0.55
2"	*	3.350	3.350
3"	*	7.390	7.390
4"	*	12.730	12.730
6"	*	28.890	28.890
8"	*	50.000	50.000
10"	*	78.850	78.850
12"	*	113.000	113.000

\* Full bore

**TABLE 7-16 - JB-TD Direct Acting Spring Valves**

ASME Actual Orifice Area and Rated Coefficient of Discharge		Air/Gas/Steam (in <sup>2</sup> )
Inlet x Outlet Size	Orifice Designation	JB-TD
		K = 0.856
10x14	V	47.85
12x16	W	68.90
12x16	W <sub>1</sub>	72.00
14x18	Y	93.78
16x18	Z	103.20
16x18	Z <sub>1</sub>	110.00
16x20	Z <sub>2</sub>	123.50
18x24	AA	155.00
20x24	BB	191.40

PRESSURE RELIEF VALVE ENGINEERING HANDBOOK  
 CHAPTER 7 - ENGINEERING SUPPORT INFORMATION - USCS UNITS (UNITED STATES CUSTOMARY SYSTEM)

**X. EQUIVALENTS AND CONVERSION FACTORS**

**TABLE 7-17 - Equivalents and Conversion Factors**

<b>A</b>	<b>B</b>	<b>C</b>
<b>Multiply</b>	<b>By</b>	<b>Obtain</b>
Atmospheres	14.70	Pounds per square inch
Atmospheres	1.033	Kilograms per sq. cm
Atmospheres	29.92	Inches of mercury
Atmospheres	760.0	Millimeters of mercury
Atmospheres	407.5	Inches of water
Atmospheres	33.96	Feet of water
Atmospheres	1.013	Bars
Atmospheres	101.3	Kilo Pascals
Barrels	42.00	Gallons (U.S.)
Bars	14.50	Pounds per square inch
Bars	1.020	Kilograms per sq. cm
Bars	100.0	Kilo Pascals
Centimeters	0.3937	Inches
Centimeters	0.03281	Feet
Centimeters	0.010	Meters
Centimeters	0.01094	Yards
Cubic centimeters	0.06102	Cubic inches
Cubic feet	7.481	Gallons
Cubic feet	0.1781	Barrels
Cubic feet per minute	0.02832	Cubic meters per minute
Cubic feet per second	448.8	Gallons per minute
Cubic inches	16.39	Cubic centimeters
Cubic inches	0.004329	Gallons
Cubic meters	264.2	Gallons
Cubic meters per hour	4.403	Gallons per minute
Cubic meters per minute	35.31	Cubic feet per minute
Standard cubic feet per min.	60.00	Standard cubic ft. per hr
Standard cubic feet per min.	1440.0	Standard cubic ft. per day
Standard cubic feet per min.	0.02716	Nm <sup>3</sup> /min. (0°C, 1 Bara)
Standard cubic feet per min.	1.630	Nm <sup>3</sup> /hr. (0°C, 1 Bara)
Standard cubic feet per min.	39.11	Nm <sup>3</sup> /day (0°C, 1 Bara)
Standard cubic feet per min.	0.02832	Nm <sup>3</sup> /min
Standard cubic feet per min.	1.699	Nm <sup>3</sup> /hr
Standard cubic feet per min.	40.78	Nm <sup>3</sup> /day
Feet	0.3048	Meters
Feet	0.3333	Yards
Feet	30.48	Centimeters
Feet of water (68°F)	0.8812	Inches of mercury (0°C)
Feet of water (68°F)	0.4328	Pounds per square inch
Gallons (U.S.)	3785.0	Cubic centimeters
Gallons (U.S.)	0.1337	Cubic feet
Gallons (U.S.)	231.0	Cubic inches
Gallons (Imperial)	277.4	Cubic inches
Gallons (U.S.)	0.8327	Gallons (Imperial)
Gallons (U.S.)	3.785	Liters
Gallons of water (60°F)	8.337	Pounds
Gallons of liquid	500 x Sp. Gr.	Pounds per hour liquid per minute
Gallons per minute	0.002228	Cubic feet per second
Gallons per minute (60°F)	227.0 x SG	Kilograms per hour
Gallons per minute	0.06309	Liters per second
Gallons per minute	3.785	Liters per minute
Gallons per minute	0.2271	M <sup>3</sup> /hr
Grams	0.03527	Ounces
Inches	2.540	Centimeters
Inches	0.08333	Feet
Inches	0.0254	Meters
Inches	0.02778	Yards

**NOTES**

This table may be used in two ways:

1. **Multiply** the unit under column A by the figure under column B, the result is the unit under column C.
2. **Divide** the unit under column C by the figure under column B, the result is then the unit under column A.

PRESSURE RELIEF VALVE ENGINEERING HANDBOOK  
 CHAPTER 7 - ENGINEERING SUPPORT INFORMATION - USCS UNITS (UNITED STATES CUSTOMARY SYSTEM)

**TABLE 7-17 - Equivalents and Conversion Factors (continued)**

<b>A</b> <b>Multiply</b>	<b>B</b> <b>By</b>	<b>C</b> <b>Obtain</b>
Inches of mercury (0°C)	1.135	Feet of water (68°F)
Inches of mercury (0°C)	0.4912	Pounds per square inch
Inches of mercury (0°C)	0.03342	Atmospheres
Inches of mercury (0°C)	0.03453	Kilograms per sq. cm
Inches of water (68°F)	0.03607	Pounds per sq. in.
Inches of water (68°F)	0.07343	Inches of mercury (0°C)
Kilograms	2.205	Pounds
Kilograms	0.001102	Short tons (2000 lbs.)
Kilograms	35.27	Ounces
Kilograms per minute	132.3	Pounds per hour
Kilograms per sq. cm	14.22	Pounds per sq. in.
Kilograms per sq. cm	0.9678	Atmospheres
Kilograms per sq. cm	28.96	Inches of mercury
Kilograms per cubic meter	0.0624	Pounds per cubic foot
Kilo Pascals	0.1450	Pounds per sq. in.
Kilo Pascals	0.0100	Bars
Kilo Pascals	0.01020	Kilograms per sq. cm
Liters	0.03531	Cubic feet
Liters	1000.0	Cubic centimeters
Liters	0.2642	Gallons
Liters per hour	0.004403	Gallons per minute
Meters	3.281	Feet
Meters	1.094	Yards
Meters	100.0	Centimeters
Meters	39.37	Inches
Pounds	0.1199	Gallons H <sub>2</sub> O at 60°F (U.S.)
Pounds	453.6	Grams
Pounds	0.0005	Short tons (2000 lbs.)
Pounds	0.4536	Kilograms
Pounds	0.0004536	Metric tons
Pounds	16.00	Ounces
Pounds per hour	6.324/M.W.	SCFM
Pounds per hour	0.4536	Kilograms per hour
Pounds per hour liquid	0.002/Sp.Gr.	Gallons per minute liquid (at 60°F)
Pounds per sq. inch	27.73	Inches of water (68°F)
Pounds per sq. inch	2.311	Feet of water (68°F)
Pounds per sq. inch	2.036	Inches of mercury (0°C)
Pounds per sq. inch	0.07031	Kilograms per sq. cm
Pounds per sq. inch	0.0680	Atmospheres
Pounds per sq. inch	51.71	Millimeters of mercury (0°C)
Pounds per sq. inch	0.7043	Meters of water (68°F)
Pounds per sq. inch	0.06895	Bar
Pounds per sq. inch	6.895	Kilo Pascals
Specific gravity (of gas or vapors)	28.97	Molecular weight (of gas or vapors)
Square centimeter	0.1550	Square inch
Square inch	6.4516	Square centimeter
Square inch	645.16	Square millimeter
SSU	0.2205 x SG	Centipoise
SSU	0.2162	Centistoke
Water (cubic feet at 60°F)	62.37	Pounds
Temperature:		
Centigrade	=	5/9 (Fahrenheit -32)
Kelvin	=	Centigrade + 273
Fahrenheit	=	9/5 (Centigrade) +32
Fahrenheit	=	Rankine -460
Fahrenheit	=	(9/5 Kelvin) -460

**NOTES**

This table may be used in two ways:

1. **Multiply** the unit under column A by the figure under column B, the result is the unit under column C.
2. **Divide** the unit under column C by the figure under column B, the result is then the unit under column A.

**CONVERSION FACTORS**

**TABLE 7-18 - Pressure Conversions<sup>[1]</sup>**

Given	To Find (To find desired value, multiply "Given" value by factor below)									
	mm wc	mbar	mm Hg	in wc	oz	kPa	in Hg	psig	kg/cm <sup>2</sup>	bars
mm wc (mm water column) (60°F or 15.6°C)	-	0.0980	0.735	0.0394	0.0227	0.00980	0.00290	0.001421	$\frac{1}{10010}$	$\frac{1}{10207}$
mbar (millibars)	10.21	-	0.750	0.4019	0.2320	0.1000	0.0296	0.01450	0.00102	0.00100
mm Hg <sup>[2]</sup> (mm Mercury) (32°F or 0°C)	13.61	1.333	-	0.5358	0.3094	0.1333	0.03948	0.01934	0.00136	0.00133
in wc (in. water column) (60°F or 15.6°C)	25.40	2.488	1.866	-	0.5775	0.2488	0.0737	0.03609	0.00254	0.00249
oz (oz/in <sup>2</sup> )	43.99	4.309	3.232	1.732	-	0.4309	0.1276	0.0625 or 1/16	0.00439	0.00431
kPa (kilopascal)	102.1	10.00	7.501	4.019	2.321	-	0.2961	0.1450	0.0102	0.0100
in Hg (in. Mercury) (60°F or 15.6°C)	344.7	33.77	25.33	13.57	7.836	3.377	-	0.4898	0.0344	0.0338
psig (lbs/in <sup>2</sup> )	703.8	68.95	51.72	27.71	16.00	6.895	2.042	-	0.0703	0.0689
kg/cm <sup>2</sup>	10010	980.7	735.6	394.1	227.6	98.07	29.04	14.22	-	0.9807
bars	10207	1000	750.1	401.9	232.1	100.0	29.61	14.50	1.020	-

**NOTES**

1. When pressure is stated in liquid column height, conversions are valid only for listed temperature.
2. Also expressed as torr.
3. Inch-Pound Standard Conditions are at sea level, equal to 14.7 psia (pounds force per square inch absolute), rounded from 14.696 psia, at a base temperature of 60°F (15.6°C).



**CONVERSION FACTORS**

**TABLE 7-19 - Gas Flow Conversions**

Given	Notes	To Find (To find desired value, multiply "Given" value by factor below)					
		scfm	scfh	lb/hr	kg/hr	Nm <sup>3</sup> /hr	Nm <sup>3</sup> /min
scfm	[1]	-	60	$\frac{M}{6.32}$	$\frac{M}{13.93}$	1.608	0.0268
scfh	[1]	0.01677	-	$\frac{M}{379.2}$	$\frac{M}{836.1}$	0.0268	0.000447
lb/hr	[2]	$\frac{6.32}{M}$	$\frac{379.2}{M}$	-	0.4536	$\frac{10.17}{M}$	$\frac{0.1695}{M}$
kg/hr	[3]	$\frac{13.93}{M}$	$\frac{836.1}{M}$	2.205	-	$\frac{22.40}{M}$	$\frac{0.3733}{M}$
Nm <sup>3</sup> /hr	[4]	0.6216	37.30	$\frac{M}{10.17}$	$\frac{M}{22.40}$	-	0.01667
Nm <sup>3</sup> /min	[4]	37.30	2238	5.901 M	2.676 M	60	-

**NOTES**

- M = molecular weight of gas.
- Volumetric flow (per time unit of hour or minute as shown) in standard cubic feet per minute at 14.7 psia, 60°F.
  - Weight flow in pounds per hour.
  - Weight flow in kilograms per hour.
  - Volumetric flow (per time unit of hour or minute as shown) at 1.013 bars absolute, 0°C. This represents the commercial standard, known as the Normal Temperature and Pressure (NTP).

Conversions from volumetric to volumetric or to weight flow (and vice versa) may only be done when the volumetric flow is expressed in the standard conditions shown above. If flows are expressed at temperature or pressure bases that differ from those listed above, they must first be converted to the standard base.

If flow is expressed in actual volume, such as cfm (cubic feet per minute) or acfm (actual cfm) as is often done for compressors, where the flow is described as displacement or swept volume, the flow may be converted to scfm as follows.

**USCS UNITS**

$$scfm = (cfm \text{ or } acfm) \times \frac{14.7 + p}{14.7} \times \frac{520}{460 + t}$$

Where:

p= gauge pressure of gas in psig

t= temperature of gas in °F

cfm or acfm= displacement or swept volume in cubic feet or actual cubic feet per minute

**CONVERSION FACTORS**

**TABLE 7-20 - LIQUID FLOW CONVERSIONS**

Given	To Find (To find desired value, multiply "Given" value by factor below)				
	l/hr	gpm (US)	gpm (Imp)	barrels/ day	m <sup>3</sup> /hr
l/hr liters/hour	-	0.00440	0.003666	0.1510	0.0010
gpm (US) US gallons per minute	227.1	-	0.8327	34.29	0.2271
gpm (Imp) Imperial gallons per minute	272.8	1.201	-	41.18	0.2728
barrels/day (petroleum) (42 US gallons)	6.624	0.02917	0.02429	-	0.006624
m <sup>3</sup> /hr cubic meters per hour	1000	4.403	3.666	151.0	-
m <sup>3</sup> /s cubic meters per second	3.6 x 10 <sup>6</sup>	15.850	13.200	543.400	3600
kg/hr kilograms per hour	$\frac{1}{G}$	$\frac{1}{227.1G}$	$\frac{1}{272.8G}$	$\frac{0.151}{G}$	$\frac{1}{1000G}$
lb/hr pounds per hour	$\frac{1}{2.205G}$	$\frac{1}{500.8G}$	$\frac{1}{601.5G}$	$\frac{1}{14.61G}$	$\frac{1}{2205G}$

**NOTE**

G = relative density of liquid at its relieving temperature to that of water at 68°F where G<sub>water</sub> = 1.00.

**CONVERSION FACTORS**

**Viscosity Units and Their Conversion**

When a correction for the effects of viscosity in the liquid orifice sizing formula is needed, the value of viscosity, expressed in centipoise, is required. Since most liquid data for viscosity uses other expressions, a convenient method for conversion is presented below.

The viscosity,  $\mu$  (Greek mu), in centipoise, is correctly known as absolute or dynamic viscosity. This is related to the kinematic viscosity expression,  $\nu$  (Greek nu), in centistokes as follows:

$$\mu = \nu \times G$$

Where:

- $\mu$  = absolute viscosity, centipoise
- $\nu$  = kinematic viscosity, centistokes
- $G$  = relative density (water = 1.00)

Most other viscosity units in common usage are also kinematic units and can be related to the kinematic viscosity in centistokes, via the accompanying table. To use this table, obtain the viscosity from data furnished. Convert this to  $\nu$ , in centistokes, then convert to absolute viscosity  $\mu$ , in centipoise.

The conversions are approximate but satisfactory for viscosity correction in liquid safety valve sizing.

**TABLE 7-21 - VISCOSITY CONVERSION**

Seconds Viscosity Centistokes $\nu$	Seconds Saybolt Universal ssu	Seconds Saybolt Furot ssf	Seconds Redwood1 (standard)	Seconds Redwood2 (Admiralty)
1.00	31	-	29.0	-
2.56	35	-	32.1	-
4.30	40	-	36.2	5.10
7.40	50	-	44.3	5.83
10.3	60	-	52.3	6.77
13.1	70	12.95	60.9	7.60
15.7	80	13.70	69.2	8.44
18.2	90	14.40	77.6	9.30
20.6	100	15.24	85.6	10.12
32.1	150	19.30	128.0	14.48
43.2	200	23.50	170.0	18.90
54.0	250	28.00	212.0	23.45
65.0	300	32.50	254.0	28.00
87.60	400	41.90	338.0	37.10
110.0	500	51.60	423.0	46.20
132.0	600	61.40	508.0	55.40
154.0	700	71.10	592.0	64.60
176.0	800	81.00	677.0	73.80
198.0	900	91.00	462.0	83.00
220.0	1000	100.70	896.0	92.10
330.0	1500	150.00	1270.0	138.20
440.0	2000	200.00	1690.0	184.20
550.0	2500	250.00	2120.0	230.00
660.0	3000	300.00	2540.0	276.00
880.0	4000	400.00	3380.0	368.00
1100.0	5000	500.00	4230.0	461.00
1320.0	6000	600.00	5080.0	553.00
1540.0	7000	700.00	5920.0	645.00
1760.0	8000	800.00	6770.0	737.00
1980.0	9000	900.00	7620.0	829.00
2200.0	10000	1000.00	8460.0	921.00
3300.0	15000	1500.00	13700.0	-
4400.0	20000	2000.00	18400.0	-

**XI - CAPACITY CORRECTION FACTOR FOR RUPTURE DISC/PRESSURE RELIEF VALVE COMBINATION,  $K_c$**

---

It may be desirable to isolate a pressure relief valve from the process fluid in the vessel that it is protecting. A non-reclosing device such as a rupture disc can be installed upstream of the pressure relief valve to provide this isolation. For example, it may be more economical to install a rupture disc made from Inconel and then mount a standard stainless steel pressure relief valve in series with the disc where the service conditions require such a high alloy material. This rupture disc/pressure relief valve combination may also be beneficial when the fluid may have entrained solids or is viscous. The rupture disc can also provide for a zero leak point during normal vessel operation.

Since the rupture disc is in the flow path of the pressure relief valve, the ASME Section VIII Code mandates that the pressure relief valve rated capacity be adjusted with a capacity combination factor ( $K_c$ ). This correction factor is determined by performing actual flow tests with specific rupture disc and pressure relief valve designs. The materials of construction, minimum size, and minimum burst pressure of the rupture disc must be specified to use this measured correction factor.

If there has been no combination testing performed then the  $K_c$  factor is equal to 0.90.

Table 7-22 lists the combination tests performed with the Crosby J series direct acting spring loaded valves. For any other Crosby brand or Anderson Greenwood brand pressure relief valve product used in series with a rupture disc, use a  $K_c$  factor equal to 0.90.

**TABLE 7-22 - Capacity Correction Factor for Rupture Disc/PRV Combination (K<sub>c</sub>)**

Emerson PRV Series	Rupture disc manufacturer	Disc type	Minimum disc size (inches)	Minimum burst pressure (psig)	Disc material	K <sub>c</sub> Factor
J05-E/JBS-E	BS&B	CSR	1.5	50	Inconel®	0.986
		JRS	1	60	316 SS	0.993
		JRS	1.5	23	Monel®	0.981
		RLS	1	138	Monel®	0.981
		RLS	1	172	Hastelloy®	0.972
		RLS	2	84.5	Monel®	0.981
		S90	1	125	Nickel	0.995
		S90	2	75	Nickel	0.994
J05-E/JBS-E	Continental Disc	CDC	1	60	Monel®/Teflon®	0.971
		CDC-FS	3	15	Monel®/Teflon®	0.986
		CDCV FS	1	60	316 SS/Teflon®	0.985
		CDCV FS	1	60	Hastelloy®/Teflon®	0.983
		CDCV FS	1.5	30	316 SS/Teflon®	0.976
		CDCV FS	1.5	30	Hastelloy®/Teflon®	0.973
		CDCV FS	3	15	316 SS/Teflon®	0.982
		CDCV FS	3	15	Hastelloy®/Teflon®	0.981
		CDCV LL	1	60	316 SS/Teflon®	0.978
		CDCV LL	1	60	Hastelloy®/Teflon®	0.960
		CDCV LL	1	60	Monel®/Teflon®	0.961
		CDCV LL	1.5	30	316 SS/Teflon®	0.959
		CDCV LL	1.5	30	Monel®/Teflon®	0.958
		CDCV LL	1.5	30	Nickel/Teflon®	0.953
		CDCV LL	3	15	316 SS/Teflon®	0.953
		CDCV LL	3	15	Monel®/Teflon®	0.979
		DCV	3	35	Monel®/Teflon®	0.994
		DCV	3	35	316 SS/Teflon®	0.978
		KBA	1	60	Monel®	0.984
		Micro X	1	150	Monel®	0.984
		Micro X	1	150	Nickel	0.990
		Micro X	2	80	316 SS	0.991
		Micro X	2	80	Inconel®	0.997
		Micro X	2	80	Monel®	0.988
		Micro X	2	80	Nickel	0.992
		ULTRX	1	60	316 SS	0.980
		MINTRX	1	60	Hastelloy®	0.987
		STARX	1	60	Inconel®	0.984
		STARX	1	60	Monel®	0.980
		STARX	1	60	Nickel	0.981
		STARX	1.5	30	316 SS	0.984
		STARX	1.5	30	Hastelloy®	0.986
STARX	1.5	30	Inconel®	0.989		
STARX	1.5	30	Monel®	0.987		
STARX	1.5	30	Nickel	0.981		
STARX	1.5	30	Tantalum	0.978		
STARX	3	15	316 SS	0.985		
STARX	3	15	Hastelloy®	0.992		
STARX	3	15	Inconel®	0.991		
STARX	3	15	Monel®	0.987		
STARX	3	15	Nickel	0.981		

**TABLE 7-22 - Capacity correction factor for rupture disc/PRV combination ( $K_v$ ) (continued)**

Emerson PRV series	Rupture disc manufacturer	Disc type	Minimum disc size (inches)	Minimum burst pressure (psig)	Disc material	$K_c$ Factor
		ZAP	1	60	Monel®	0.985
		ZAP	1	60	316 SS	0.985
		ZAP	1	60	Inconel®	0.988
		ZAP	1	60	Nickel	0.992
		ZAP	1.5	30	316 SS	0.955
		ZAP	1.5	30	Monel®	0.955
		ZAP	1.5	30	Nickel	0.992
		ZAP	3	35	Inconel®	0.992
		ZAP	3	35	Monel®	0.982
		ZAP	3	35	Nickel	1.000
		ZAP	3	35	316 SS	0.970
<b>JOS-E/JBS-E</b>	<b>Fike</b>	Axius	1	15	316 SS	0.987
		MRK	1	60	316 SS	0.967
		MRK	1	60	Nickel	0.977
		MRK	3	35	316 SS	0.982
		MRK	3	35	Nickel	0.995
		Poly-SD CS	1	124	Aluminum	0.970
		Poly-SD DH	1	32	Aluminum	0.997
		SRL	1	27	SS Nickel	0.979
		SRX	1	95	Nickel	0.996
<b>JOS-E/JBS-E</b>	<b>OSECO</b>	COV	2	31	Monel®/Teflon®	0.979
		FAS	1.5	90	Nickel	0.975
		PCR	1.5	90	Nickel	0.967

**THE FOLLOWING DATA WITH CHARTS AND TABLES ARE INCLUDED IN THIS CHAPTER**

---

I. Compressibility Factor, Z .....8.3

II. Capacity Correction Factor for Back Pressure,  $K_b$ .....8.4

III. Capacity Correction Factor for High Pressure Steam,  $K_n$  .....8.31

IV. Capacity Correction Factor for Viscosity,  $K_v$  .....8.31

V. Capacity Correction Factor for Superheat,  $K_{sh}$  .....8.33

VI. Ratio of Specific Heats,  $k$ , and Coefficient,  $C$  .....8.35

VII. Typical Fluid Properties.....8.36

VIII. Steam Saturation Pressure/Temperature .....8.40

IX. Orifice Area and Coefficient of Discharge for  
Anderson Greenwood and Crosby Pressure Relief Valve .....8.41

X. Equivalentents and Conversion Factors .....8.48

XI. Capacity Correction Factor for Rupture Disc/Pressure Relief Device Combination,  $K_c$  .....8.54

# PRESSURE RELIEF VALVE ENGINEERING HANDBOOK

## CHAPTER 8 - ENGINEERING SUPPORT INFORMATION - METRIC UNITS

### THE FOLLOWING FIGURES ARE INCLUDED IN THIS CHAPTER

Figure 8-1	Nelson Obert Compressibility Chart .....	8.3
Figure 8-2	Effect of Built-up Back Pressure on Conventional PRV .....	8.4
Figure 8-3	Relationship of $P_2$ and $P_2'$ .....	8.6
Figure 8-4	Valve Selection Recommendations for Built-up Back Pressure Installations.....	8.7
Figure 8-5	Valve Selection Recommendations for Constant Superimposed Back Pressure Installations (no built-up back pressure).....	8.8
Figure 8-6	Valve Selection Recommendations for Variable Superimposed Back Pressure Installations .....	8.9
Figure 8-7	Valve Selection Recommendations for Constant Superimposed Back Pressure Installations (with built-up back pressure).....	8.10
Figure 8-8	Crosby Series JOS-E Conventional Direct Spring PRV Back Pressure Correction Factor ( $K_b$ ) Gas/Steam Service.....	8.11
Figure 8-9	Crosby Series JLT-JOS-E Conventional Direct Spring PRV Back Pressure Correction Factor ( $K_b$ ) Gas/Steam Service .....	8.12
Figure 8-10	Crosby Series JBS-E/JLT-JBS-E Balanced Bellows Direct Spring PRV Back Pressure Correction Factor ( $K_b$ ) Gas/Steam Service .....	8.13
Figure 8-11	Crosby Series JLT-JBS-E Balanced Bellows Direct Spring PRV Back Pressure Correction Factor ( $K_w$ ) Liquid Service .....	8.14
Figure 8-12	Crosby Series 800 Conventional Direct Spring PRV Back Pressure Correction Factor ( $K_b$ ) Gas/Steam Service .....	8.15
Figure 8-13	Crosby Series 900 Conventional Direct Spring PRV Back Pressure Correction Factor ( $K_b$ ) Gas/Steam Service .....	8.16
Figure 8-14	Crosby Series BP Back Pressure Correction Factor ( $K_w$ ) Liquid Service .....	8.17
Figure 8-15	Crosby Series BP Back Pressure Correction Factor ( $K_b$ ) Gas Service .....	8.18
Figure 8-16	Anderson Greenwood Series 61 Conventional Direct Spring PRV Back Pressure Correction Factor ( $K_b$ ) Gas Service .....	8.19
Figure 8-17	Anderson Greenwood Series 63B [-5 Orifice Only] Conventional Direct Spring PRV Back Pressure Correction Factor ( $K_b$ ) Gas.....	8.20
Figure 8-18	Anderson Greenwood Series 63B [-7 Orifice Only] Conventional Direct Spring PRV Back Pressure Correction Factor ( $K_b$ ) Gas.....	8.21
Figure 8-19	Anderson Greenwood Series 81P Back Pressure Correction Factor ( $K_w$ ) Liquid Service .....	8.22
Figure 8-20	Anderson Greenwood Series 81/83/86 Conventional Direct Spring PRV Back Pressure Correction Factor ( $K_b$ ) Gas/Steam .....	8.23
Figure 8-21	Anderson Greenwood Series 81P [-8 Orifice Only] Balanced Piston Direct Spring PRV Back Pressure Correction Factor ( $K_b$ ) Gas .....	8.24
Figure 8-22	Anderson Greenwood Series 90/9000 POPRV Back Pressure Correction Factor ( $K_b$ ) Gas Service .....	8.25
Figure 8-23	Anderson Greenwood Series 40 Pilot Operated PRV Back Pressure Correction Factor ( $K_b$ ) Gas/Steam Service .....	8.26
Figure 8-24	Anderson Greenwood Series 50 Pilot Operated PRV Back Pressure Correction Factor ( $K_b$ ) Gas/Steam Service .....	8.27
Figure 8-25	Anderson Greenwood Series 60 Pilot Operated PRV Back Pressure Correction Factor ( $K_b$ ) Gas/Steam Service .....	8.28
Figure 8-26	Anderson Greenwood Series LCP Pilot Operated PRV Back Pressure Correction Factor ( $K_b$ ) Gas Service .....	8.29
Figure 8-27	Anderson Greenwood Series 727 Pilot Operated PRV Back Pressure Correction Factor ( $K_b$ ) Gas/Steam Service .....	8.30
Figure 8-28	Correction Factor for High Pressure Steam ( $K_n$ ) .....	8.31
Figure 8-29	Viscosity Correction Factor ( $K_v$ ) .....	8.32
Figure 8-30	Ratio of Specific Heats, $k$ , and Coefficient, $C$ .....	8.35

### THE FOLLOWING TABLES ARE INCLUDED IN THIS CHAPTER

Table 8-1	Superheat Correction Factor.....	8.33
Table 8-2	Gas Constant.....	8.35
Table 8-3	Physical Properties for Selected Gases.....	8.36
Table 8-4	Physical Properties for Selected Liquids.....	8.38
Table 8-5	Saturated Steam Pressure Table .....	8.40
Table 8-6	JOS-E/JBS-E/JLT-E Full Nozzle Direct Acting Spring Valves (API Effective Orifice Areas/API Effective Coefficient of Discharge).....	8.42
Table 8-7	JOS-E/JBS-E/JLT-E Full Nozzle Direct Acting Spring Valves (ASME Areas/ASME Coefficient of Discharge).....	8.42
Table 8-8	OMNI 800/900/BP Portable Direct Acting Spring Valves Orifice Areas/Coefficient of Discharge.....	8.43
Table 8-9	Series 60 and Series 80 Portable Direct Acting Spring Valves Orifice Areas/API Effective Coefficient of Discharge .....	8.43
Table 8-10	H Series Direct Acting Spring Safety Valves Orifice Areas/Coefficient of Discharge.....	8.44
Table 8-11	High Pressure Pilot Operated Valves (API Effective Orifice Areas/Coefficient of Discharge) .....	8.44
Table 8-12	High Pressure Pilot Operated Valves (ASME Areas/ASME Coefficient of Discharge) .....	8.45
Table 8-13	Low Pressure Pilot Operated Valves (Set Pressure $\geq 15$ psig) Orifice Areas/Coefficient of Discharge .....	8.46
Table 8-14	Low Pressure Pilot Operated Valves (Set Pressure $< 15$ psig) Orifice Areas/Coefficient of Discharge .....	8.46
Table 8-15	Low Pressure Pilot Operated Valves Orifice Areas/Coefficient of Discharge .....	8.47
Table 8-16	JB-TD Direct Acting Spring Valves Orifice Areas/Coefficient of Discharge .....	8.47
Table 8-17	Equivalents and Conversion Factors.....	8.48
Table 8-18	Pressure Conversions .....	8.50
Table 8-19	Gas Flow Conversions .....	8.51
Table 8-20	Liquid Flow Conversions .....	8.52
Table 8-21	Viscosity Conversion .....	8.53
Table 8-22	Capacity Correction Factor for Rupture Disc/PRV Combination.....	8.55



**I. COMPRESSIBILITY FACTOR, Z**

The gas and vapor formulas of this handbook are based on perfect gas laws. Many real gases and vapors, however, deviate from a perfect gas. The compressibility factor Z is used to compensate for the deviations of real gases from the ideal gas.

The compressibility factor may be determined from thermodynamic charts such as the Nelson Obert compressibility chart shown in Figure 8-1.

Z is a function of the reduced pressure and the reduced temperature of the gas. The reduced temperature is equal to the ratio of the actual absolute inlet gas temperature to the absolute critical temperature of the gas.

$$T_r = \frac{T}{T_c}$$

Where:

$T_r$  = Reduced temperature

T = Inlet fluid temperature, °C + 273

$T_c$  = Critical temperature, °C + 273

The reduced pressure is equal to the ratio of the actual absolute inlet pressure to the critical pressure of the gas.

$$P_r = \frac{P}{P_c}$$

Where:

$P_r$  = Reduced pressure

P = Relieving pressure

(set pressure + overpressure + atmospheric pressure), bara

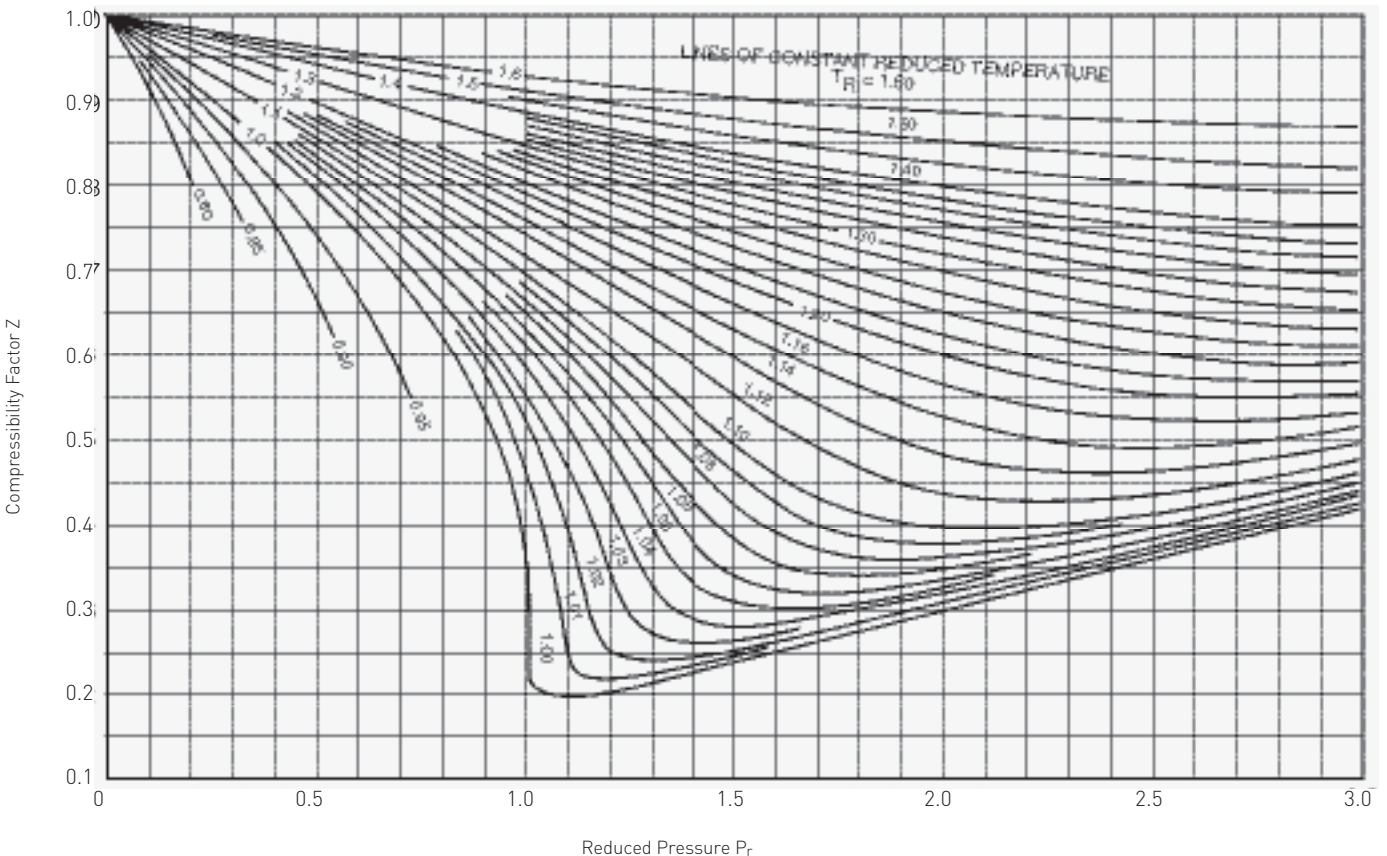
$P_c$  = Critical pressure, bara

Enter the chart at the value of reduced pressure, move vertically to the appropriate line of constant reduced temperature.

From this point, move horizontally to the left to read the value of Z.

In the event the compressibility factor for a gas or vapor cannot be determined, a conservative value of Z = 1 is commonly used.

FIGURE 8-1 - Nelson Obert Compressibility Chart



**II. CAPACITY CORRECTION FACTORS FOR BACK PRESSURE,  $K_b$**

**General**

Back pressure can exist in any location that is downstream from the actual discharge area of a pressure relief valve. This pressure can be due to piping causing resistance to flow, pressures from other equipment discharging to a common header system, or from a flashing fluid being relieved. Without proper consideration of the effects of back pressure, the PRV may experience one, some or all of the following.

- Change in set pressure
- Change in reseating pressure
- Lift instability
- Decrease in actual relieving capacity

This particular section of the engineering handbook will deal with the sizing capacity correction factors that need to be considered for various types of pressure relief valves.

**Built-up Back Pressure**

As you recall from Chapter Three, a pressure relief valve whose outlet is discharging to atmosphere or into a piping system will experience built-up back pressure. This type of back pressure is only evident after the valve has opened and is relieving, it does not affect the set pressure of the PRV.

For a conventional PRV, the change in the force balance of the disc holder due to back pressure will hinder the upward lifting force. The conservative rule of thumb is that if the built-up back pressure exceeds the available overpressure to lift the valve, then a conventional valve should not be used because the lifting force may not be sufficient for the valve to operate in a stable fashion. Figure 8-2 illustrates the effect built-up back pressure has upon a conventional PRV design where there is 10% overpressure available. If there was a fire case contingency where there may be 21% overpressure, then a curve similar to Figure 8-2 would show full capacity up to 21% built-up back pressure.

An exception to this conventional valve built-up back pressure and overpressure relationship is the Crosby brand H series product that is normally provided for ASME Section I applications. The H series valve is normally provided with the open spring bonnet design. This opening to atmosphere dramatically decreases the built-up back pressure amount that acts down on the disc holder. For this valve design, when the H series valve is in lift with 3% overpressure, the calculated built-up back pressure at the outlet flange of the valve can be up to a maximum of 27.5% of the set pressure.

There is no capacity correction factor in either gas/vapor or liquid applications for a suitable conventional prv where the valve is exposed to built-up back pressure which is less than the available overpressure. In other words, the  $K_b$  or  $K_w$  will be 1.0.

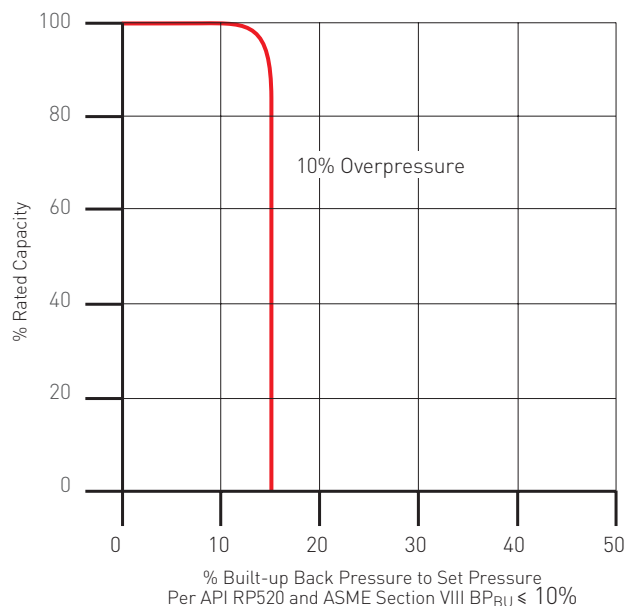
When a balanced direct spring or pilot operated PRV is open and flowing against a built-up back pressure, the lift of the device should be stable if properly designed. The built-up back pressure can exceed the available overpressure for these devices. However, the capacity that the PRV is able to deliver may be less than expected due to a reduced, but stable, lift and/or a compressible fluid flow transitions from critical to subcritical conditions.

The calculation of the magnitude of the built-up back pressure, and the subsequent design of the outlet piping for a new installation, is oftentimes an iterative process.

- The PRV is initially sized with the assumption of a maximum built-up back pressure. For instance, in an application that may require the process fluid exhaust to be routed via a simple tail pipe discharge to atmosphere, the sizing for the PRV may assume a built-up back pressure to be 10% of the flowing pressure. This assumption would allow the use of a conventional direct spring PRV.

- The PRV required minimum orifice is then selected based upon a  $K_b = 1.0$ .
- Once the PRV is selected, the engineer should perform a pressure drop calculation for the proposed size and style of discharge pipe. In the example above, the pressure drop through the tailpipe should be determined.
- The API Standard 521 will guide the engineer to use the rated capacity for some types of direct spring operated PRV (recall that safety valves obtain substantial lift at the set pressure) or the required capacity for a modulating action pilot operated PRV to calculate the pressure loss in the discharge piping. This will provide the magnitude of built-up back pressure at the outlet flange of the PRV.
- If this calculated built-up back pressure exceeds 10% then, for this example, the tailpipe may need to be redesigned to provide less resistance to flow. Perhaps enlarging or straightening this fitting is possible to reduce the built-up back pressure.
- If the outlet piping cannot be changed, then a balanced or pilot operated PRV may need to be considered and the iterative process begins again. We will discuss the correction factors for balanced and pilot operated PRVs below.

FIGURE 8-2  
 Effect of Built-up Back Pressure on Conventional PRV



**Superimposed Back Pressure**

When the outlet of a PRV is connected to a closed discharge system, it may not only be exposed to built-up back pressure but may also see superimposed back pressure. The superimposed back pressure is evident on the downstream side of the PRV before the valve has opened. This is very common in process plant environments where effluents are captured or thermally oxidized via common header systems. This superimposed back pressure may be a constant value but it could vary in these types of installations.

A conventional, unbalanced PRV can be considered if the superimposed back pressure is a constant value. As we learned in Chapter Three, one can set the conventional PRV with a bias on the test bench to account for this constant superimposed back pressure. All unbalanced Crosby and Anderson Greenwood brand PRVs have a force balance that will cause a unit-for-unit increase in the in situ opening pressure when superimposed back pressure is present. In other words, if there is 3 barg of superimposed back pressure the unbalanced valve will open 3 barg higher than the opening pressure allowed by just the spring compression. For this example, the spring compression can be set 3 barg lower to compensate for the constant superimposed back pressure. As you recall, this bias is one element of the cold differential set pressure (CDTP) setting.

A balanced direct acting or pilot operated PRV does not need any test bench correction for superimposed back pressure. Therefore, when the superimposed back pressure is variable it is recommended to use these particular valve designs.

The calculation of superimposed back pressure is performed by examining the entire pressure relief disposal system and making determinations regarding whether or not other devices attached to the system may be operating at the time the PRV is to open and then relieve. These effluent flows are then used with the disposal system piping geometry to determine what the superimposed back pressure may be at the outlet flange of the PRV. The maximum superimposed back pressure should be listed on the PRV data sheet.

**Compressible Fluid Back Pressure Correction Charts**

There are several figures in this chapter that show back pressure correction factors for various series of Emerson products used in compressible media service. For example, Figure 8-8 shows the  $K_b$  factor for the Crosby JOS-E conventional PRV and we will use this chart to help explain why these back pressure capacity corrections are needed.

Properly setting a conventional PRV, such as the Crosby JOS-E, with a CDTP will provide an adequate lift to meet its certified capacity. This is contingent upon any built-up back pressure that is developed will not exceed the available overpressure at the set pressure. In gas service, there may be a capacity correction factor required for conventional PRVs. The  $K_b$  factor in this case is a result of the flow becoming what is called subcritical at the discharge area of the PRV.

When the flow is critical at the discharge area of the PRV it can also be called "choked flow." This means that even if the back pressure is reduced there can be no more flow capacity provided through the PRV. Once the flow becomes subcritical then any change in back pressure will change the capacity.

The transition from critical to subcritical flow is based upon the critical pressure of the gas service. This critical pressure is calculated as follows:

$$P_{critical} = P_1 \left[ \frac{2}{K+1} \right]^{\frac{k}{k-1}}$$

Where:

$P_1$  =  $P_{set}$  + Overpressure + atmospheric - inlet pressure piping loss, bara

$k$  = ratio of specific heat

If the sum of the built-up back pressure and superimposed back pressure exceed this critical pressure then the capacity will be reduced. As an example, let us consider the gas as air with a ratio of specific heats equal to 1.4. Let us assume that the absolute relieving pressure ( $P_1$ ) is 10 barg. After performing the calculation above, the critical pressure will be equal to 5.28 barg. This means that capacity will be reduced when the total back pressure at the outlet of the discharge area is greater than 5.28 barg.

As mentioned above, the calculation of the superimposed and built-up back pressure gives a value for these pressures at the PRV outlet flange. The capacity of the PRV is determined by the conditions at the location of the actual discharge area. For the Crosby JOS-E series valve this is the nozzle outlet. If you look at Figure 8-3, the total calculated superimposed and built-up back pressure is denoted by  $P_2$  while it is the  $P_2'$  pressure at the nozzle outlet that determines whether the flow is critical or subcritical. The outlet of the body of the JOS-E creates additional built-up back pressure that is not accounted for in the total (built-up plus superimposed) back pressure calculations at the outlet flange, making the value of  $P_2'$  higher than  $P_2$ . Therefore, using Figure 8-8 and our previous example where the critical pressure is 5.28 barg, you will note in the figure that when the calculated total back pressure is approximately 20% of the flowing pressure we begin to adjust the capacity with the  $K_b$  value. This is well below the expected 0.528 critical pressure ratio or 5.28 barg critical pressure. This is due to the  $P_2'$  and  $P_2$  relationship. The  $P_2'$  is actually above the critical pressure when the calculated total back pressure at the outlet flange ( $P_2$ ) is reaching 20% of the flowing pressure. This same  $P_2'$  and  $P_2$  relationship holds for other valve designs such as the Crosby balanced bellows and most of the Anderson Greenwood pilot operated PRVs. This relationship is also a contributor to the liquid  $K_w$  correction factors for various valve designs. Use the following flow charts (Figures 8-4 through 8-7) to assist with selecting an appropriate Emerson model recommendation and back pressure capacity correction factor.

FIGURE 8-3  
Relationship of  $P_2'$  and  $P_2$

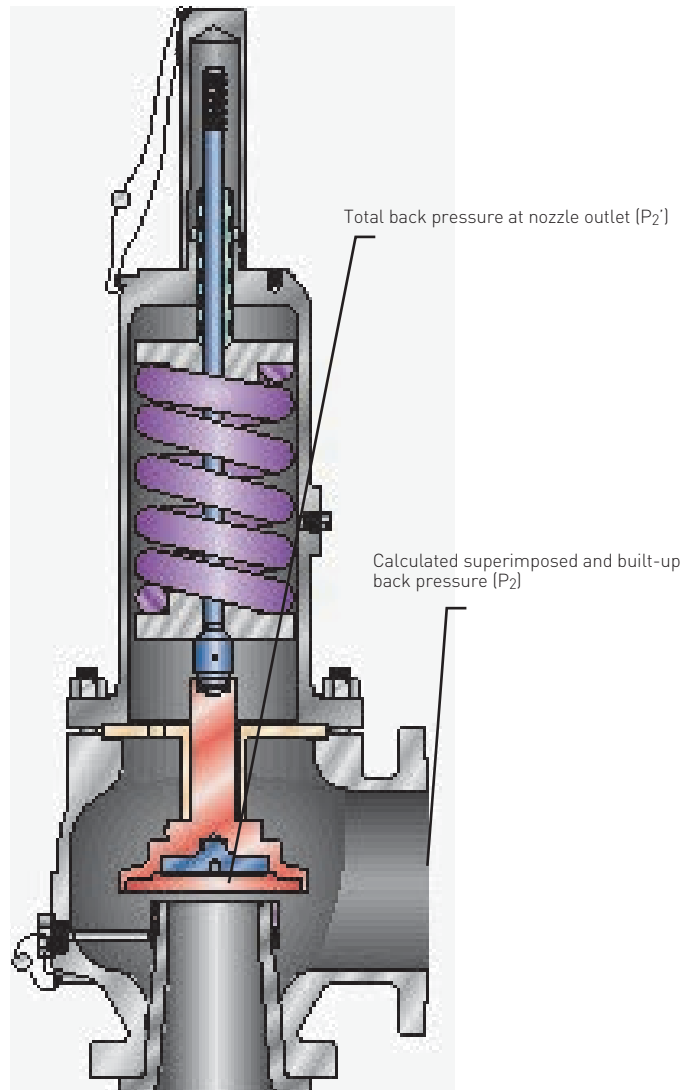


FIGURE 8-4  
 Valve Selection Recommendations for Built-up Back Pressure Installations

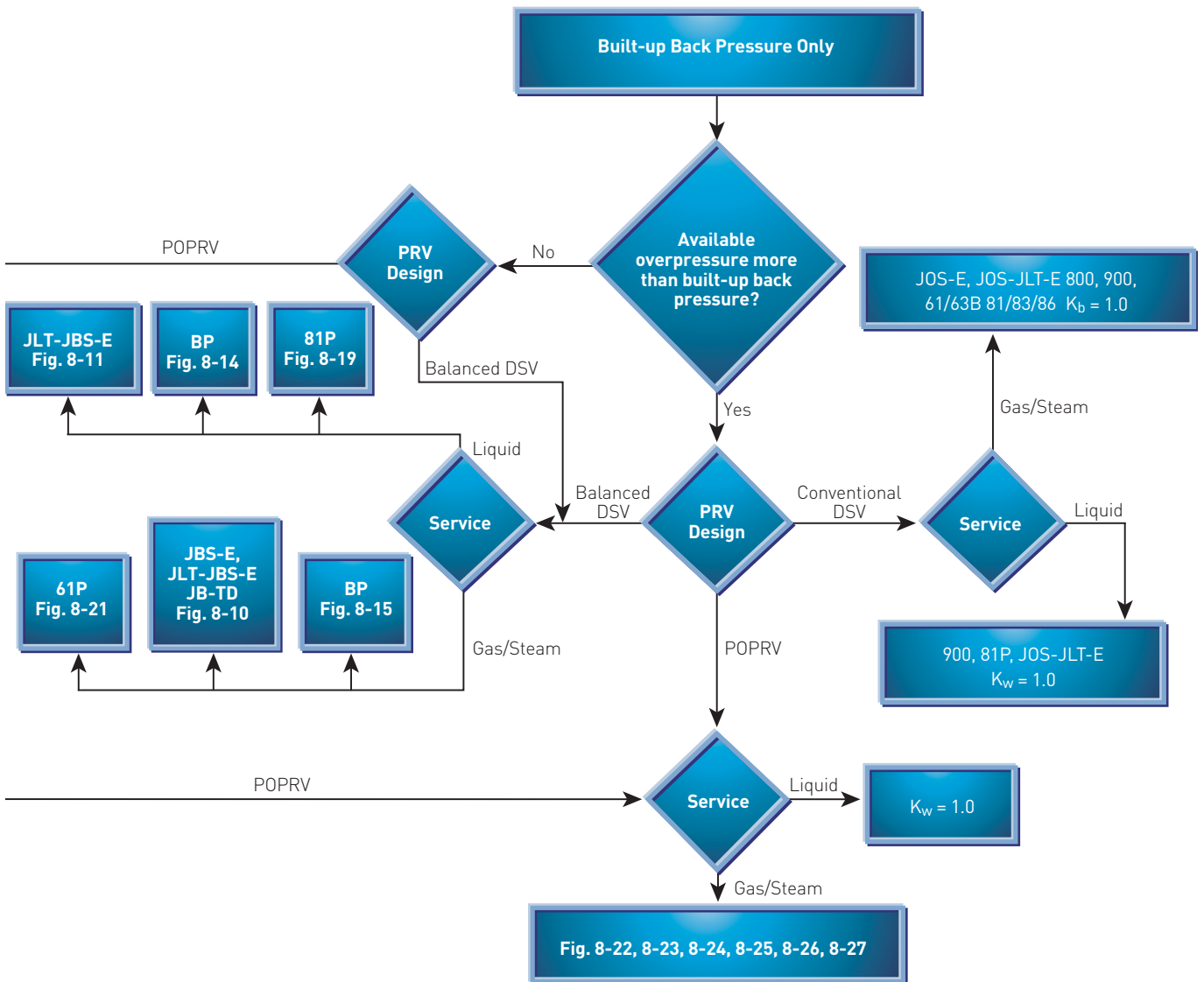


FIGURE 8-5  
 Valve Selection Recommendations for Constant Superimposed Back Pressure Installations (No Built-up Back Pressure)

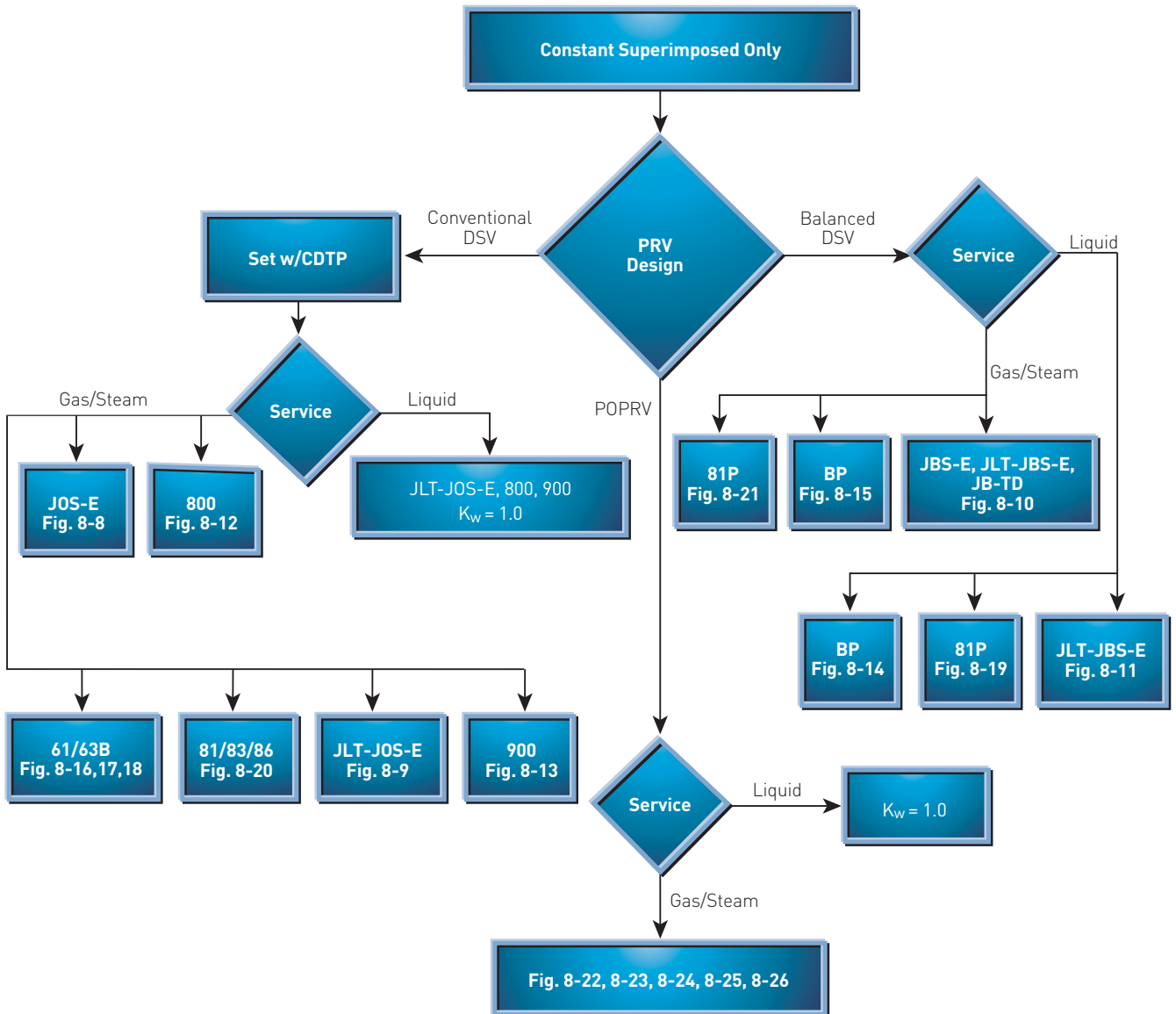


FIGURE 8-6  
 Valve Selection Recommendations for Variable Superimposed Back Pressure Installations

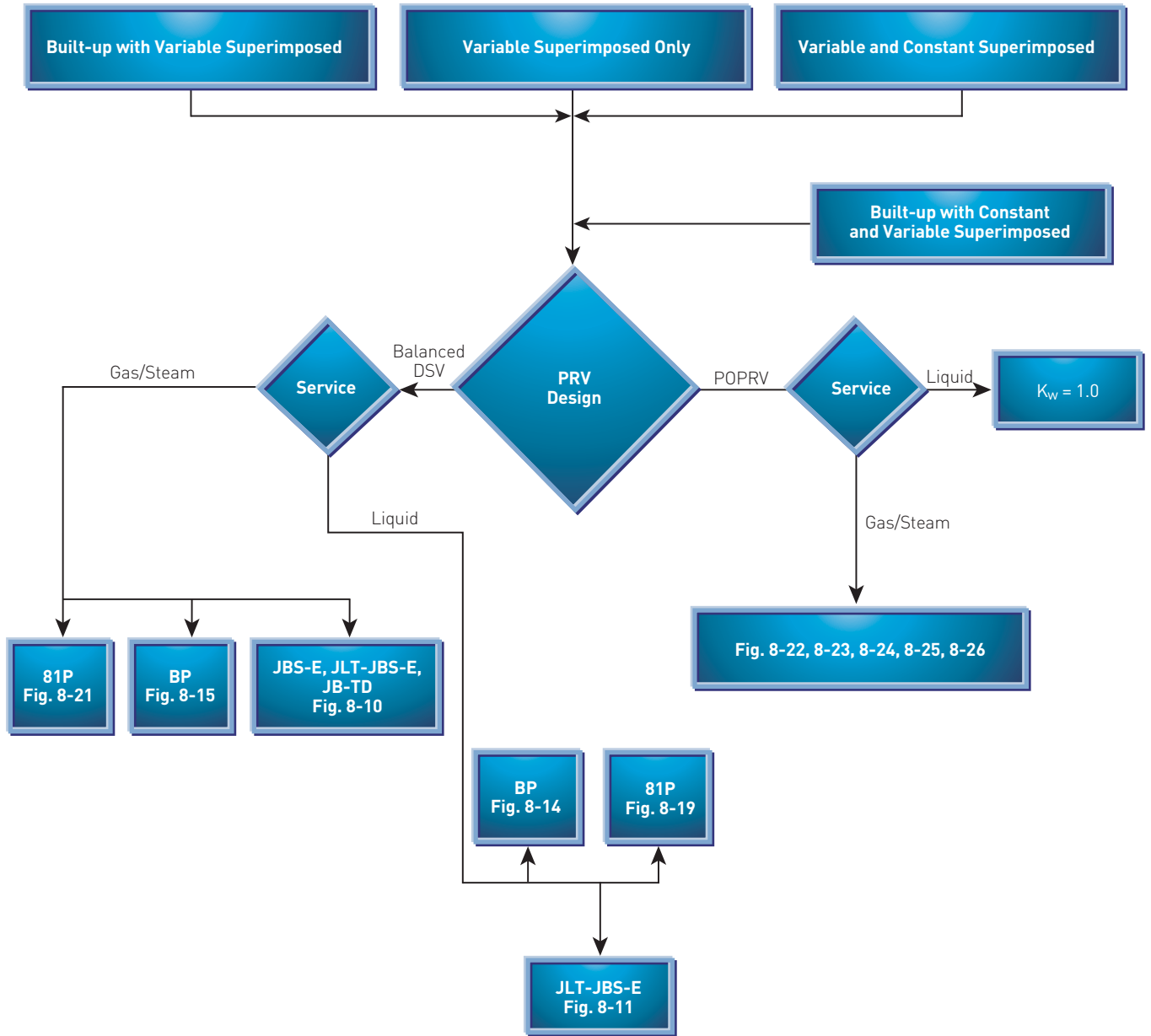


FIGURE 8-7  
 Valve Selection Recommendations for Constant Superimposed Back Pressure Installations (with Built-up Back Pressure)

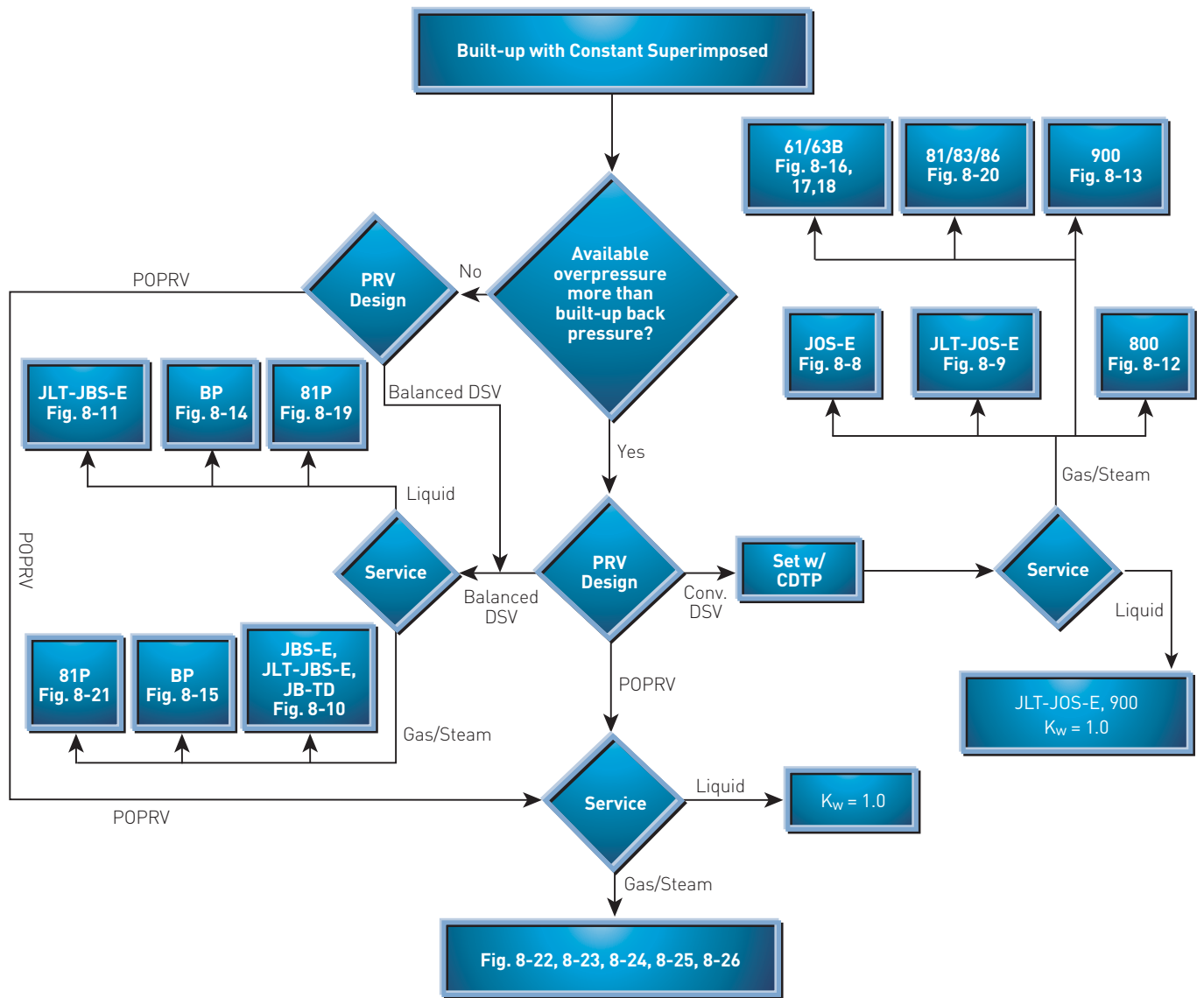
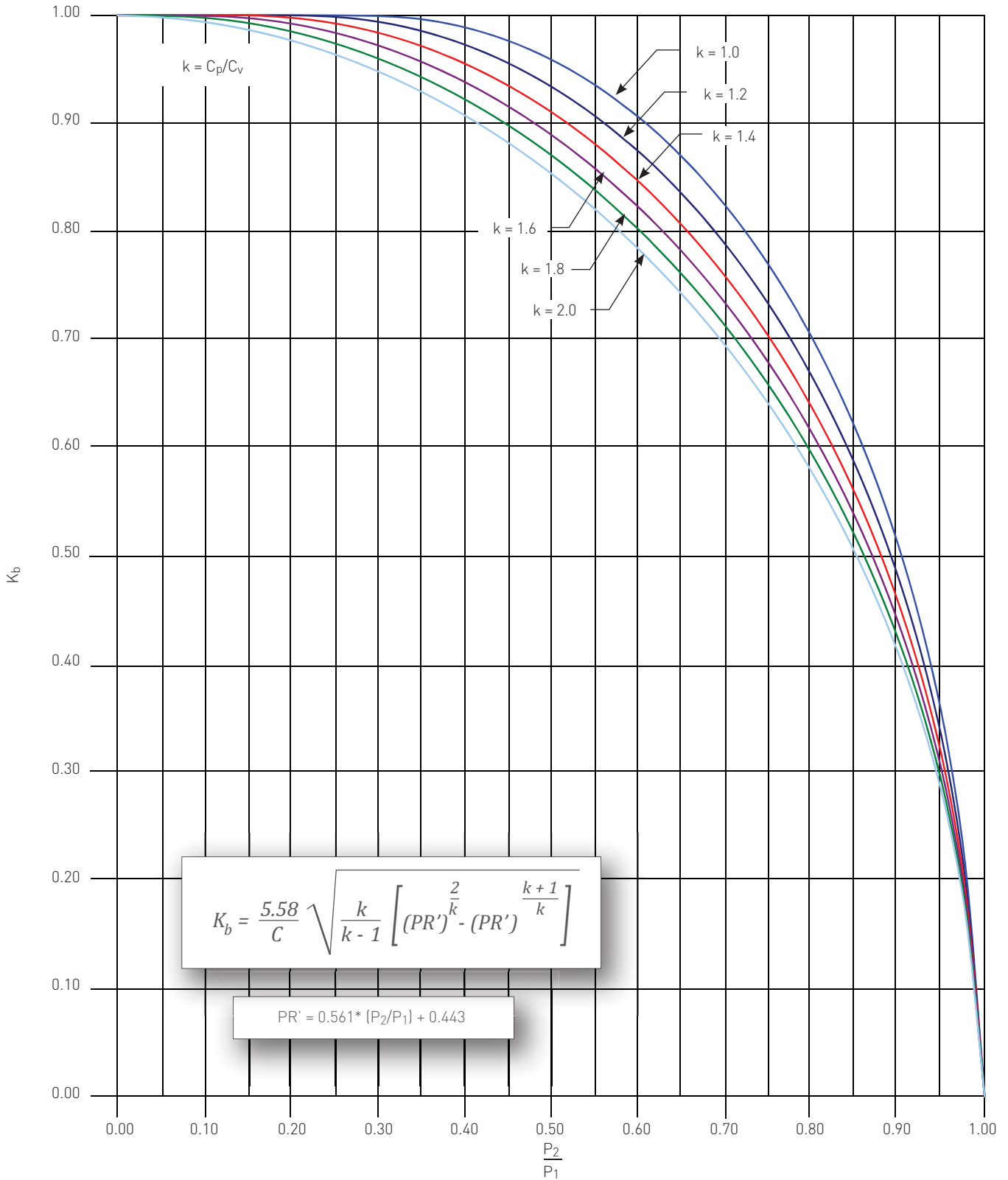




FIGURE 8-8  
 Crosby Series JOS-E Conventional Direct Spring PRV Back Pressure Correction Factor ( $K_b$ ) - Gas/Steam Service

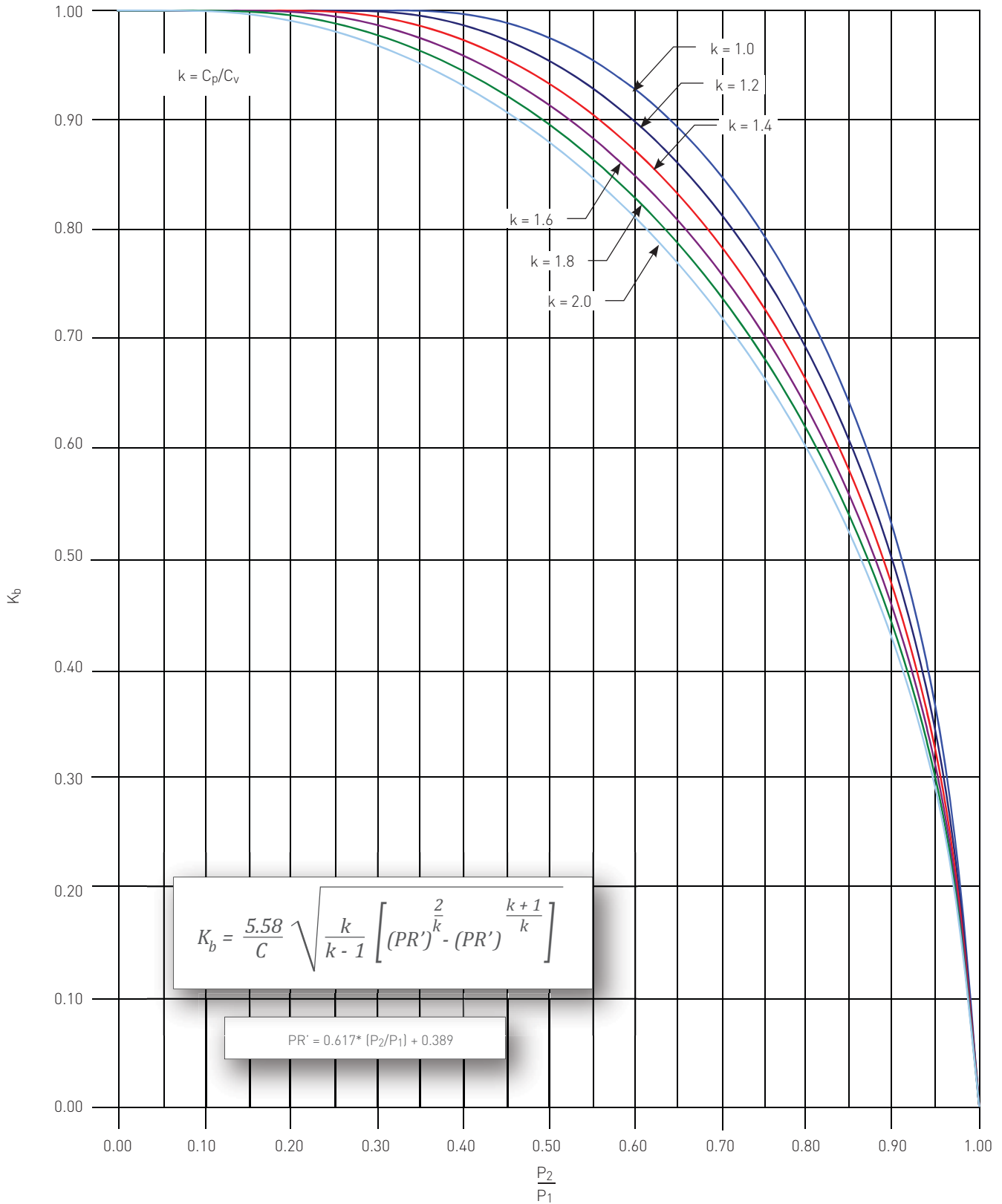


Where:

$P_2$  = Pressure at valve outlet during flow, bara. This is total back pressure (barg) + atmospheric pressure (bara)

$P_1$  = Relieving pressure, bara. This is the set pressure (barg) + overpressure (barg) + atmospheric pressure (bara) - inlet pressure piping loss (barg)

FIGURE 8-9  
 Crosby Series JLT-JOS-E Conventional Direct Spring PRV Back Pressure Correction Factor ( $K_b$ ) - Gas Service

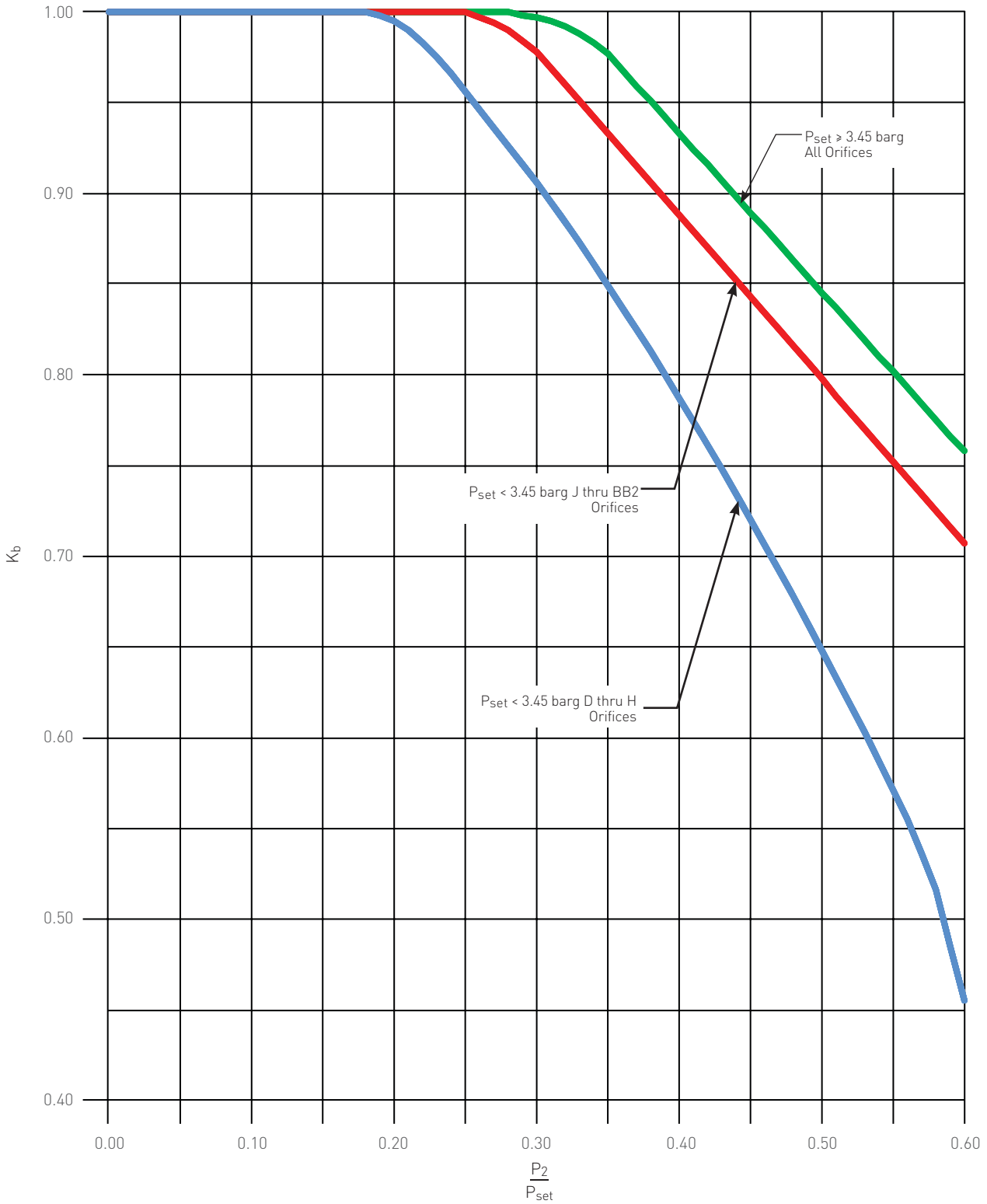


Where:

$P_2$  = Pressure at valve outlet during flow, bara. This is total back pressure [barg] + atmospheric pressure [bara]

$P_1$  = Relieving pressure, bara. This is the set pressure (barg) + overpressure (barg) + atmospheric pressure (bara) - inlet pressure piping loss (barg)

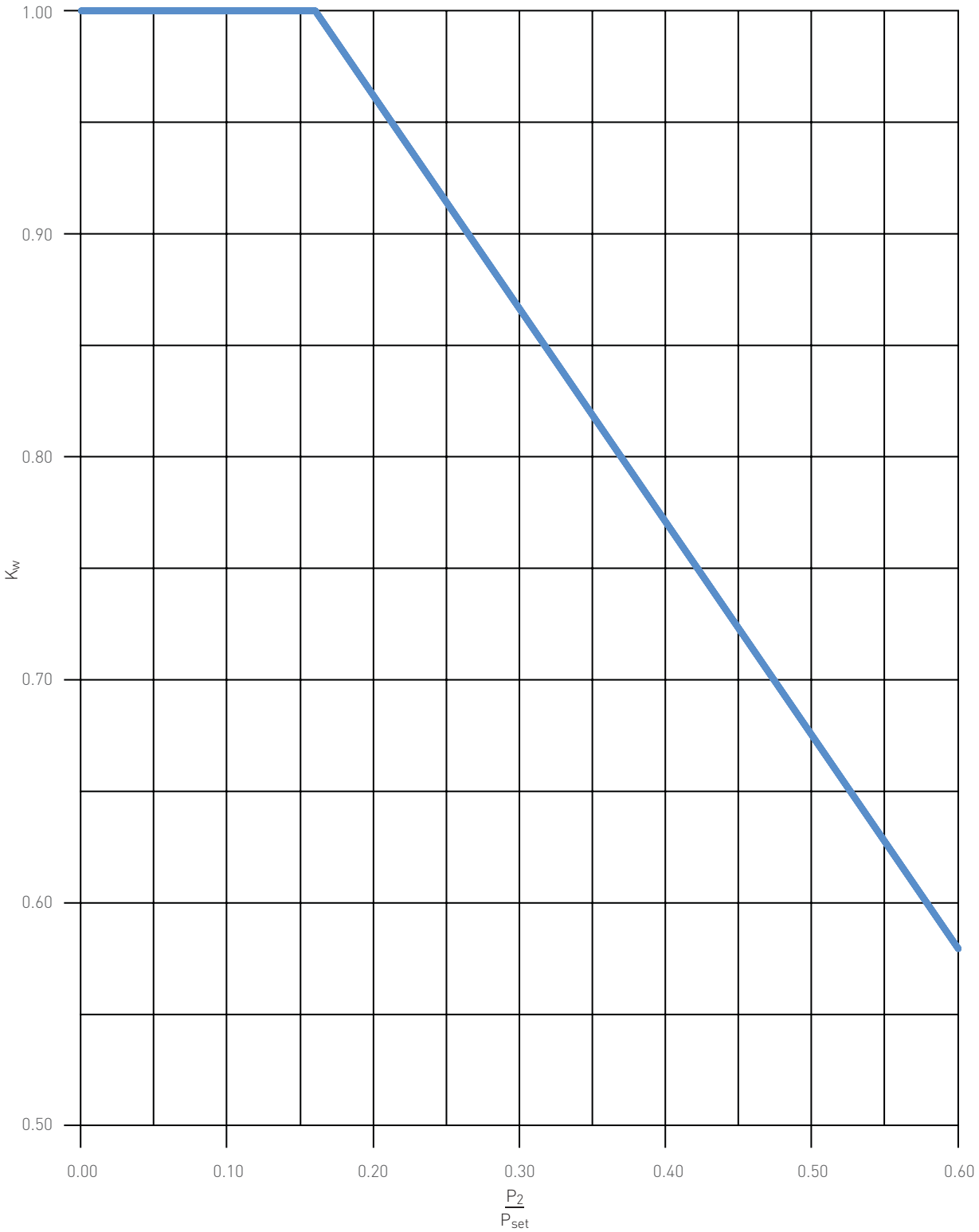
FIGURE 8-10  
 Crosby Series JBS-E/JLT-JBS-E/JB-TD Balanced Bellows Direct Spring PRV Back Pressure Correction Factor ( $K_b$ ) - Gas/Steam Service



Where:  
 $P_2$  = Pressure at valve outlet during flow. This is the total back pressure (barg).  
 $P_{set}$  = Set pressure (barg)

**NOTE**  
 This figure is based upon 10% overpressure.  
 The  $K_b$  factor shown will be conservative for higher overpressure values.

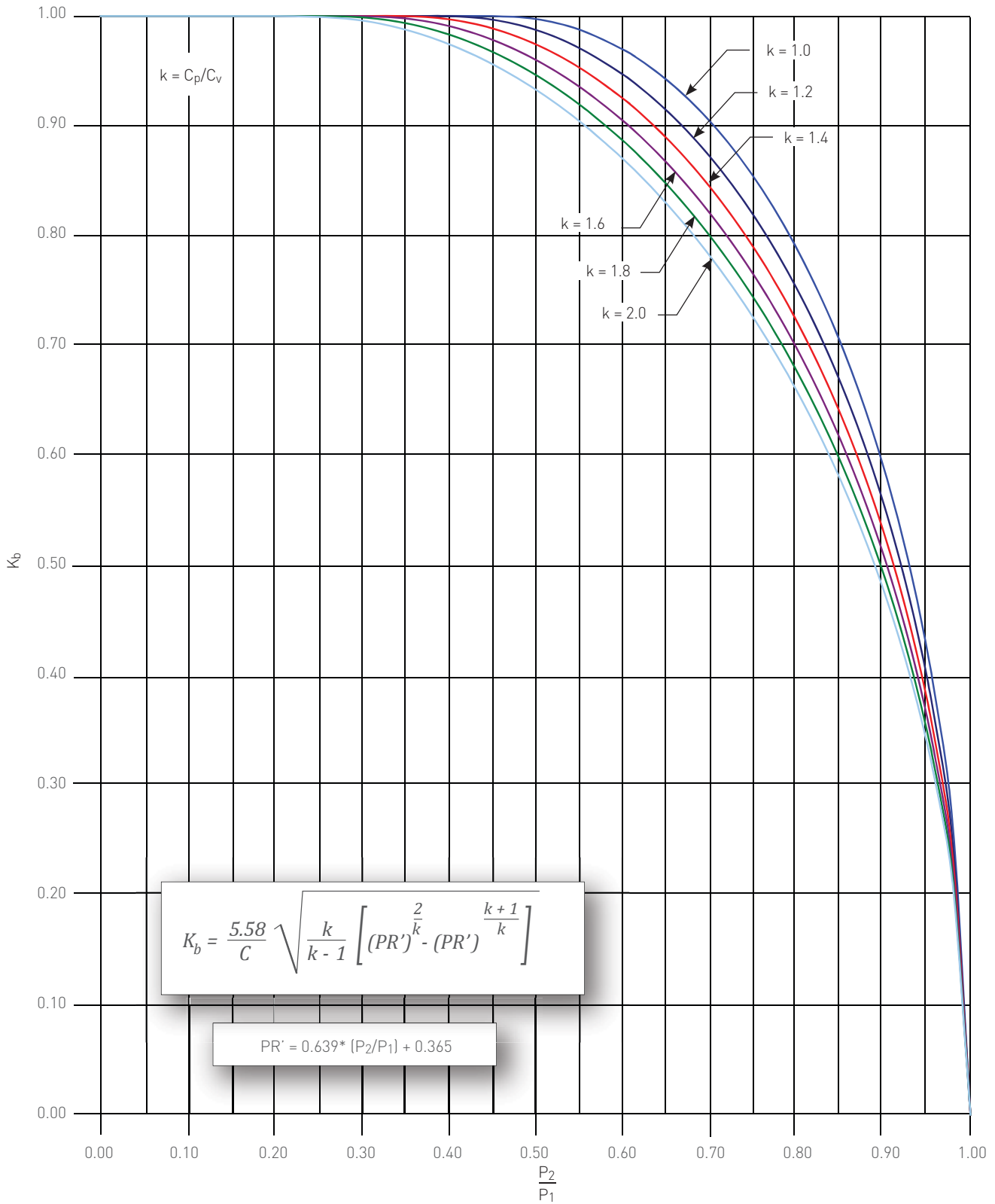
FIGURE 8-11  
 Crosby Series JLT-JBS-E Balanced Bellows Direct Spring PRV Back Pressure Correction Factor ( $K_w$ ) - Liquid Service



Where:  
 $P_2$  = Pressure at valve outlet during flow, psig. This is the total back pressure (barg).  
 $P_{set}$  = Set pressure (barg)

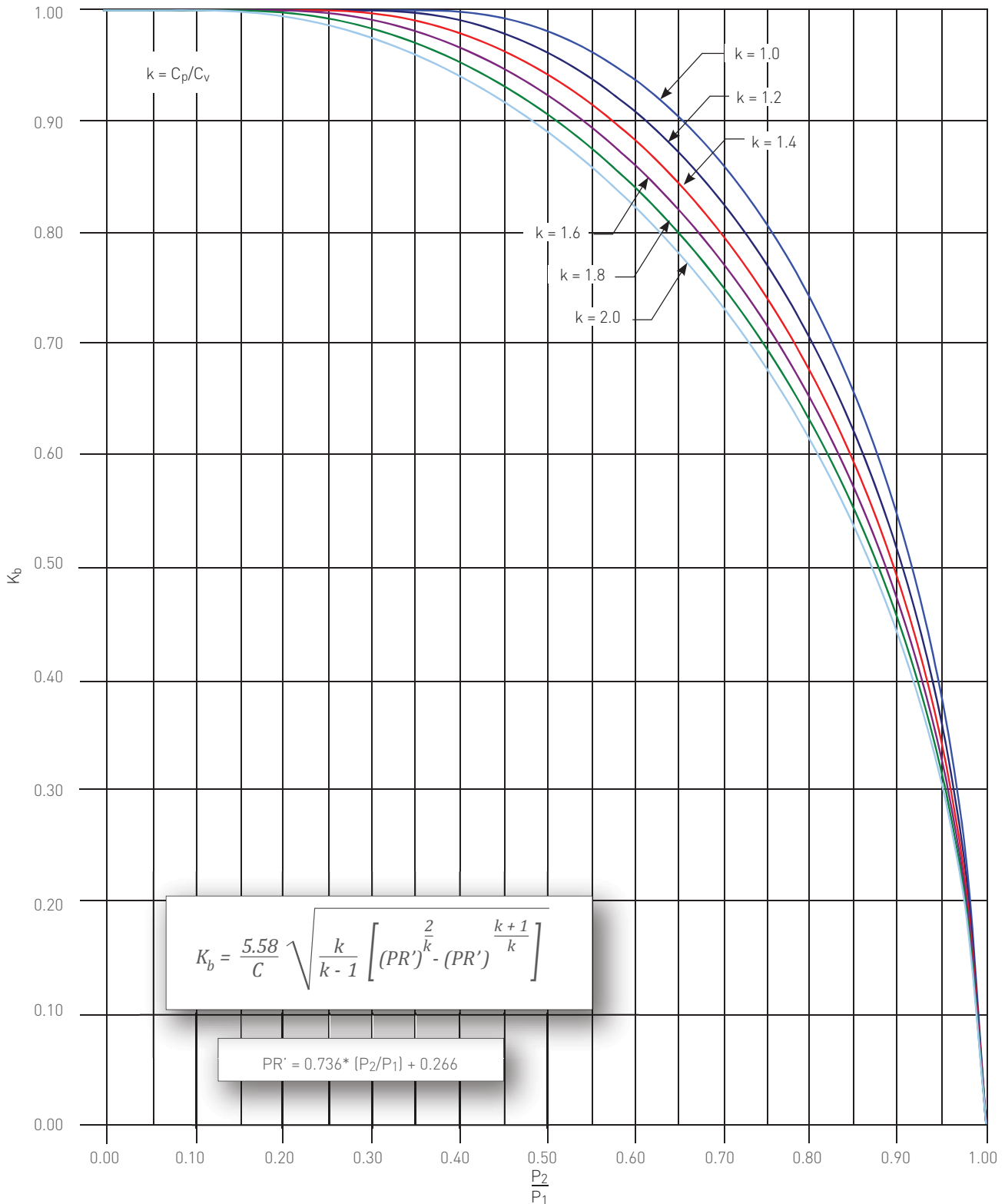
**NOTE**  
 This figure is based upon 10% overpressure.  
 The  $K_w$  factor shown will be conservative for higher overpressure values.

FIGURE 8-12  
 Crosby Series 800 Conventional Direct Spring PRV Back Pressure Correction Factor ( $K_b$ ) - Gas/Steam Service



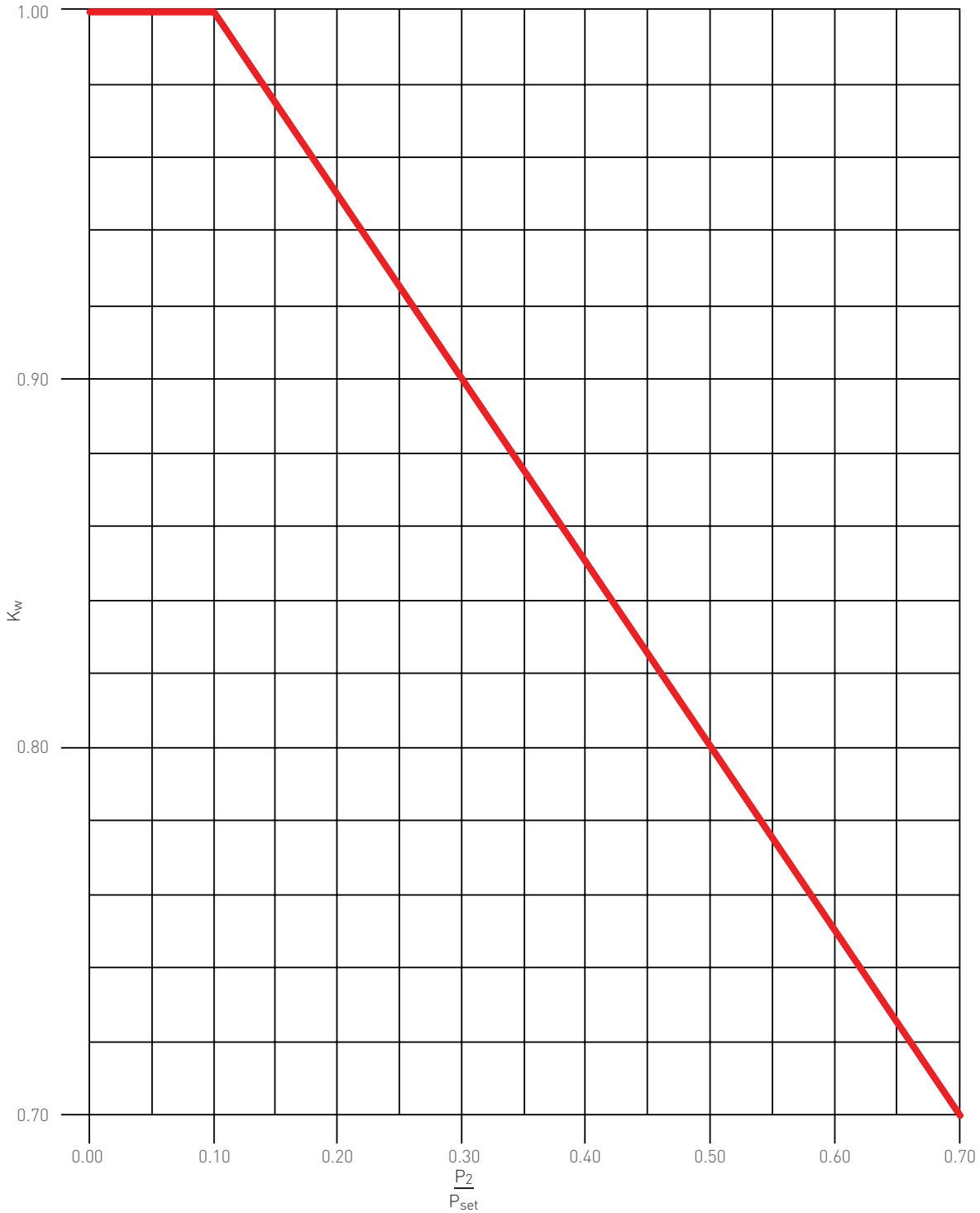
Where:  
 $P_2$  = Pressure at valve outlet during flow, bara. This is total back pressure (barg) + atmospheric pressure (bara)  
 $P_1$  = Relieving pressure, bara. This is the set pressure (barg) + overpressure (barg) + atmospheric pressure (bara) - inlet pressure piping loss (barg)

FIGURE 8-13  
 Crosby Series 900 Conventional Direct Spring PRV Back Pressure Correction Factor ( $K_b$ ) - Gas/Steam Service



Where:  
 $P_2$  = Pressure at valve outlet during flow, bara. This is total back pressure (barg) + atmospheric pressure (bara)  
 $P_1$  = Relieving pressure, bara. This is the set pressure (barg) + overpressure (barg) + atmospheric pressure (bara) - inlet pressure piping loss (barg)

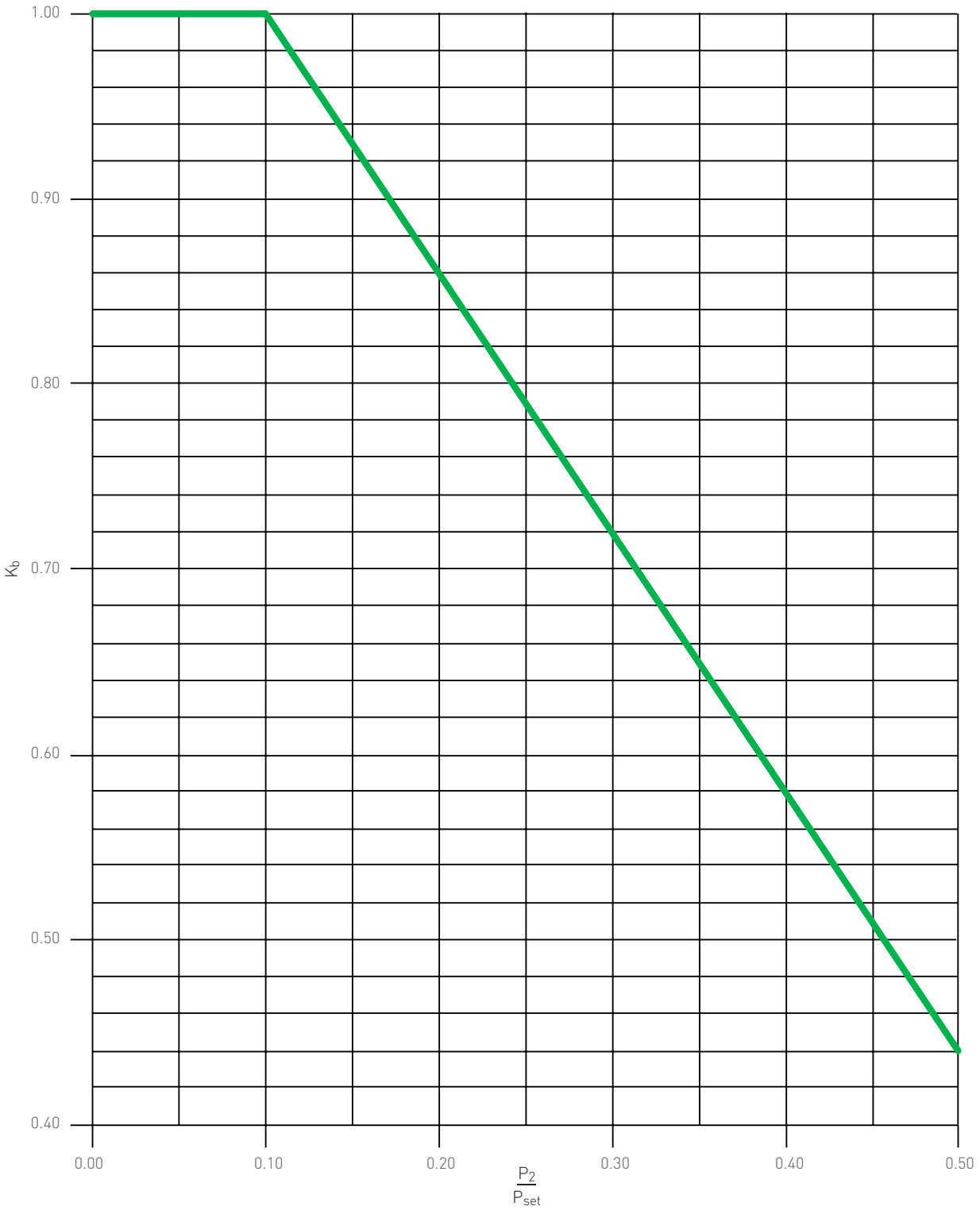
FIGURE 8-14  
Crosby Series BP Back Pressure Correction Factor ( $K_w$ ) - Liquid Service



Where:  
 $P_2$  = Pressure at valve outlet during flow, barg. This is the total back pressure (barg)  
 $P_{set}$  = Set pressure (barg)

**NOTE**  
This figure is based upon 10% overpressure.  
The  $K_w$  factor shown will be conservative for higher overpressure values.

FIGURE 8-15  
 Crosby Series BP Back Pressure Correction Factor ( $K_b$ ) - Gas Service



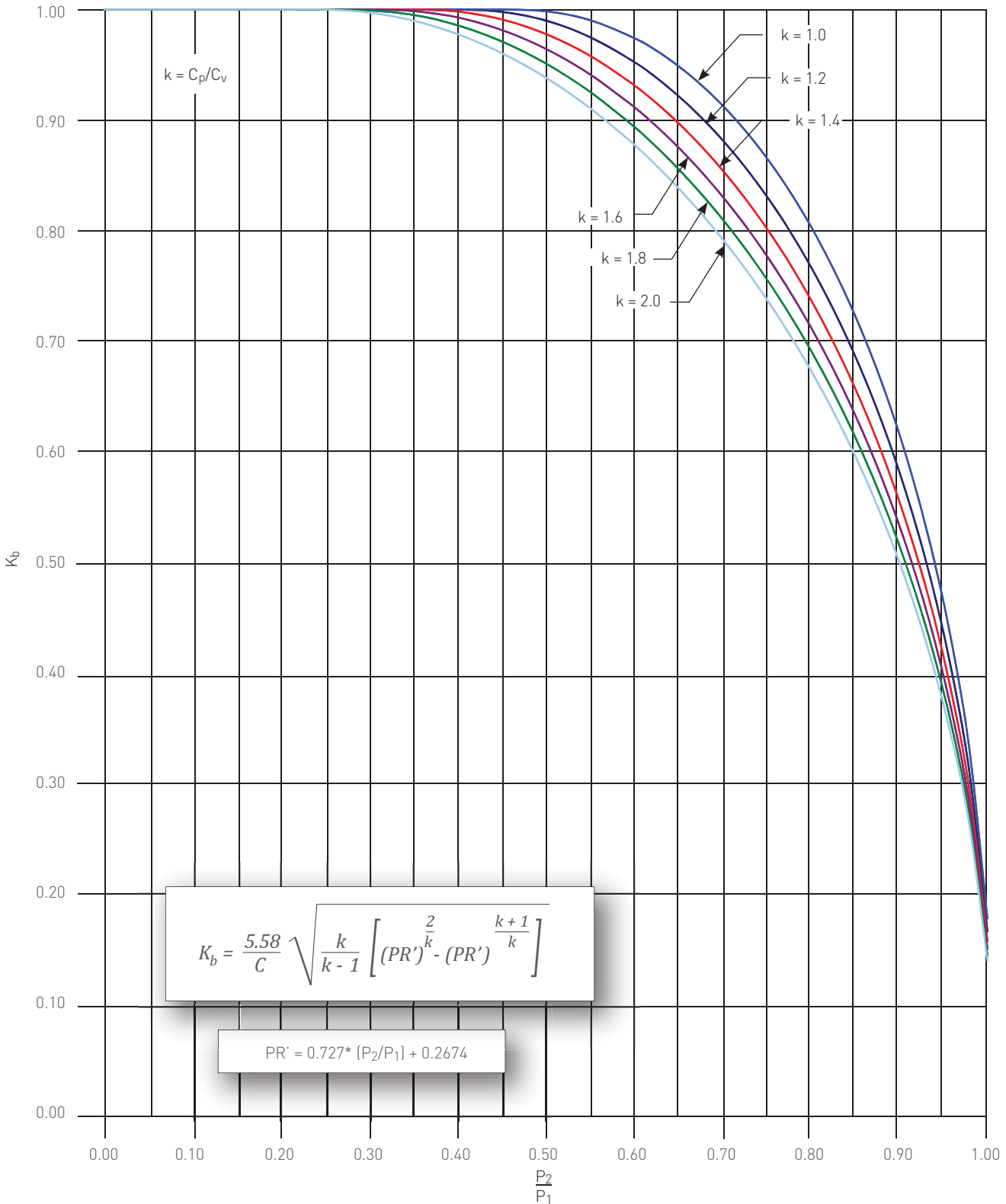
Where:  
 $P_2$  = Pressure at valve outlet during flow, barg. This is the total back pressure (barg)  
 $P_{set}$  = Set pressure (barg)

**NOTE**  
 This figure is based upon 10% overpressure.  
 The  $K_b$  factor shown will be conservative for higher overpressure values.



FIGURE 8-16

Anderson Greenwood Series 61 Conventional Direct Spring PRV Back Pressure Correction Factor ( $K_b$ ) - Gas Service

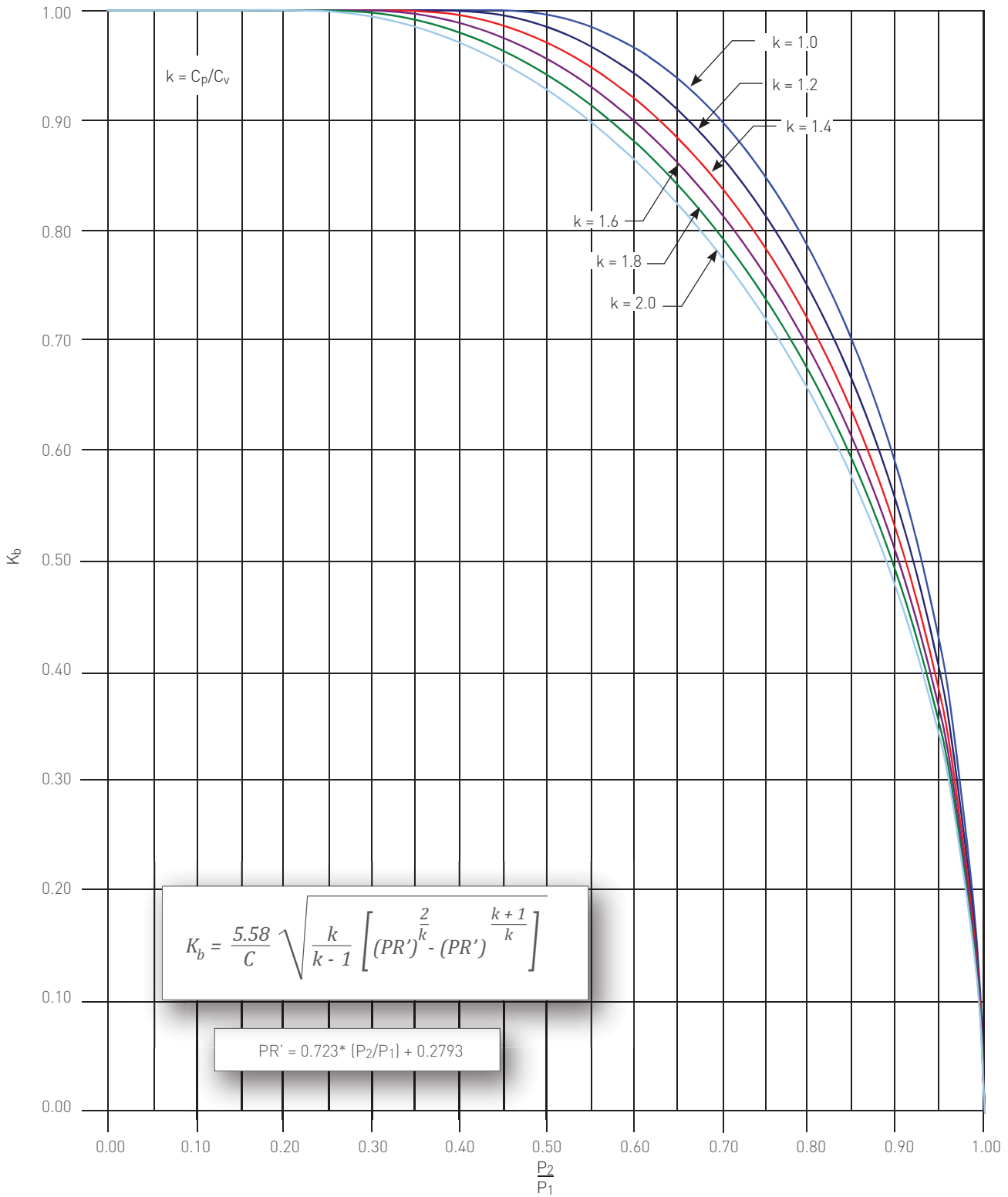


Where:

$P_2$  = Pressure at valve outlet during flow, bara. This is total back pressure (barg) + atmospheric pressure (bara)

$P_1$  = Relieving pressure, bara. This is the set pressure (barg) + overpressure (barg) + atmospheric pressure (bara) - inlet pressure piping loss (barg)

FIGURE 8-17  
 Anderson Greenwood Series 63B (-5 Orifice Only) Conventional Direct Spring PRV Back Pressure Correction Factor (Kb) - Gas Service

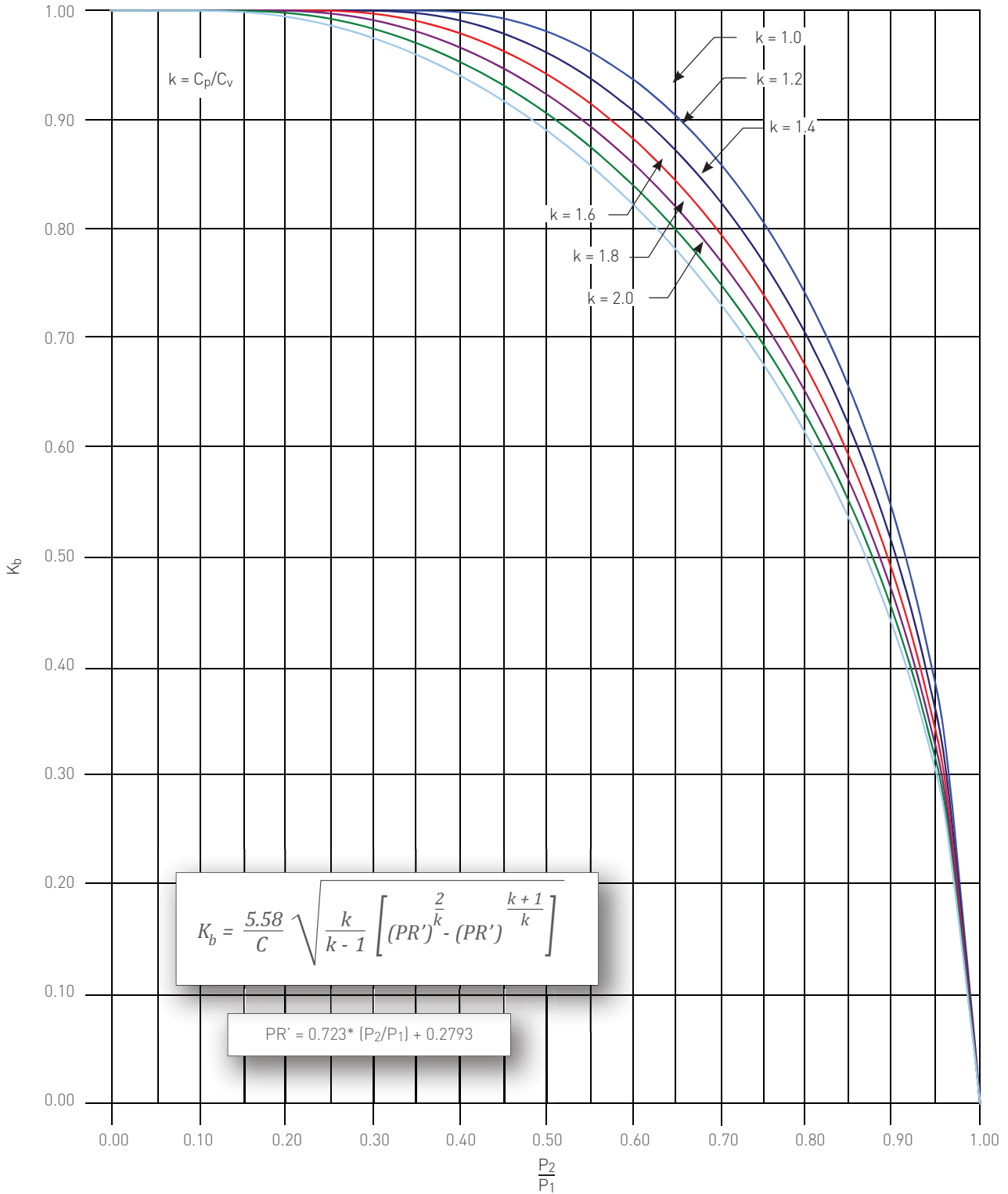


Where:

$P_2$  = Pressure at valve outlet during flow, bara. This is total back pressure (barg) + atmospheric pressure (bara)

$P_1$  = Relieving pressure, bara. This is the set pressure (barg) + overpressure (barg) + atmospheric pressure (bara) - inlet pressure piping loss (barg)

FIGURE 8-18  
 Anderson Greenwood Series 63B (-7 Orifice Only) Conventional Direct Acting PRV Back Pressure Correction Factor ( $K_b$ ) - Gas Service

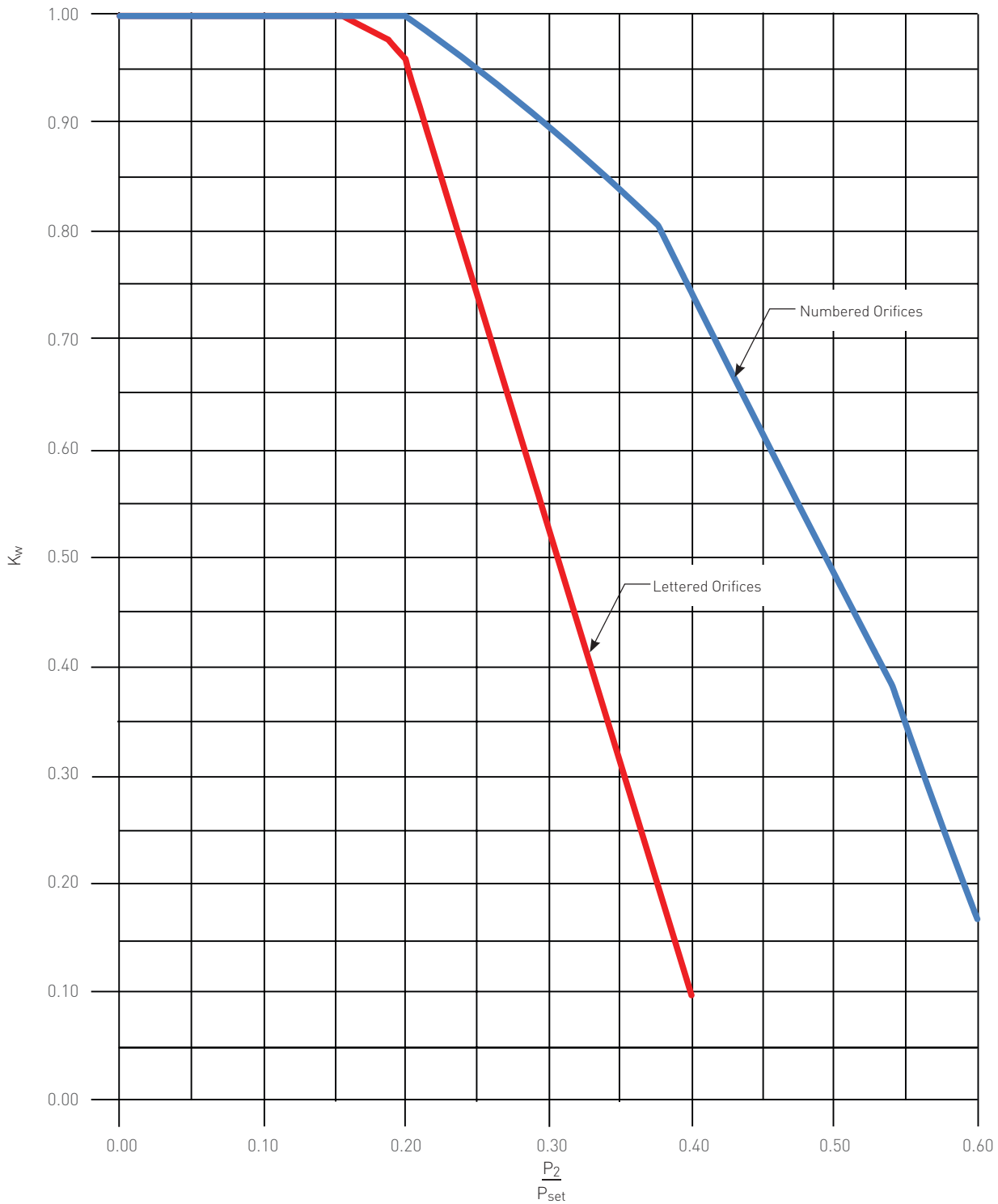


Where:

$P_2$  = Pressure at valve outlet during flow, bara. This is total back pressure (barg) + atmospheric pressure (bara)

$P_1$  = Relieving pressure, bara. This is the set pressure (barg) + overpressure (barg) + atmospheric pressure (bara) - inlet pressure piping loss (barg)

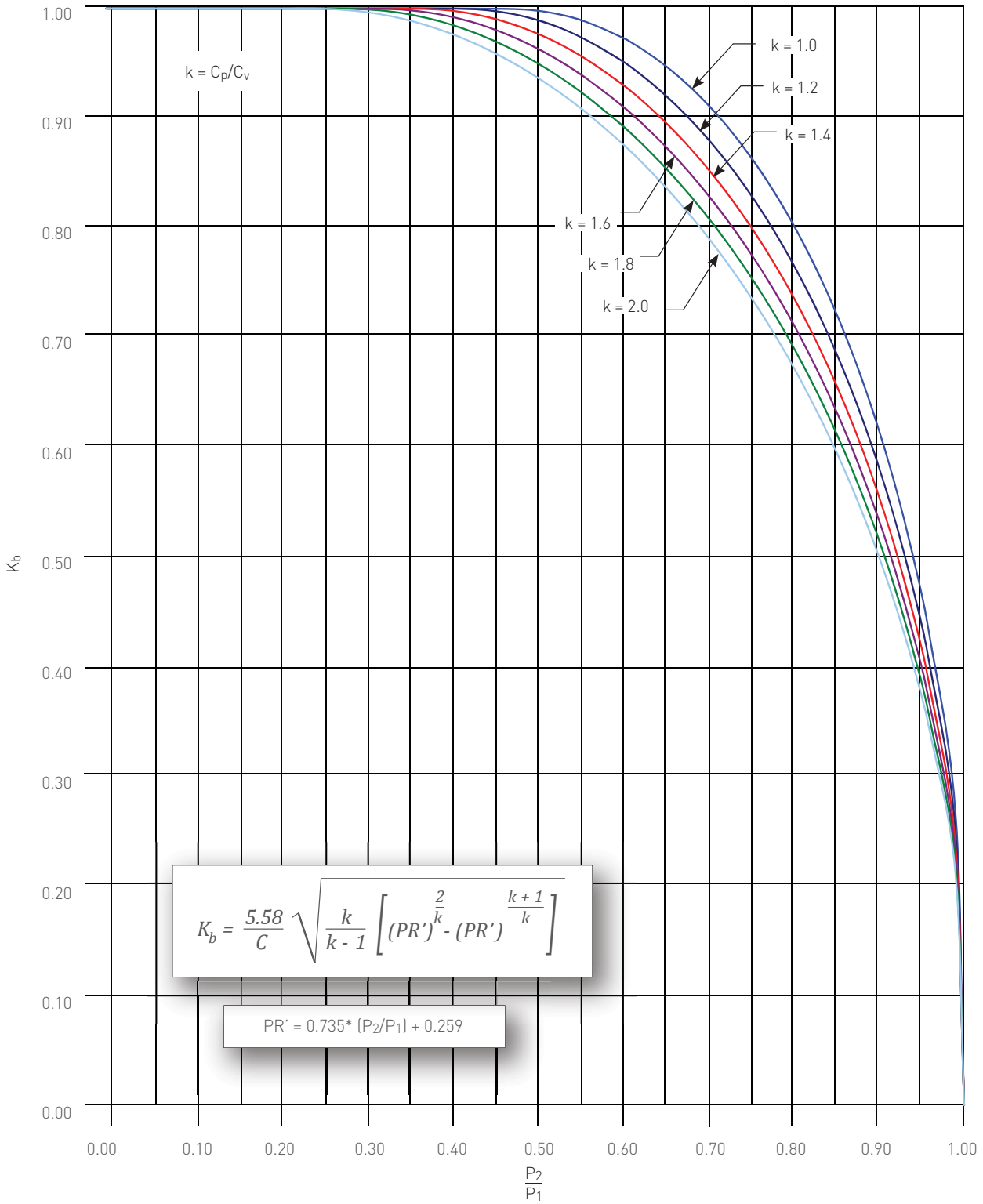
FIGURE 8-19  
 Anderson Greenwood Series 81P Back Pressure Correction Factor ( $K_w$ ) - Liquid Service



Where:  
 $P_2$  = Pressure at valve outlet during flow, barg. This is the total back pressure (barg)  
 $P_{set}$  = Set pressure (barg)

**NOTE**  
 This figure is based upon 10% overpressure.  
 The  $K_w$  factor shown will be conservative for higher overpressure values.

FIGURE 8-20  
 Anderson Greenwood Series 81/83/86 Conventional Direct Spring PRV Back Pressure Correction Factor ( $K_b$ ) - Gas/Steam Service

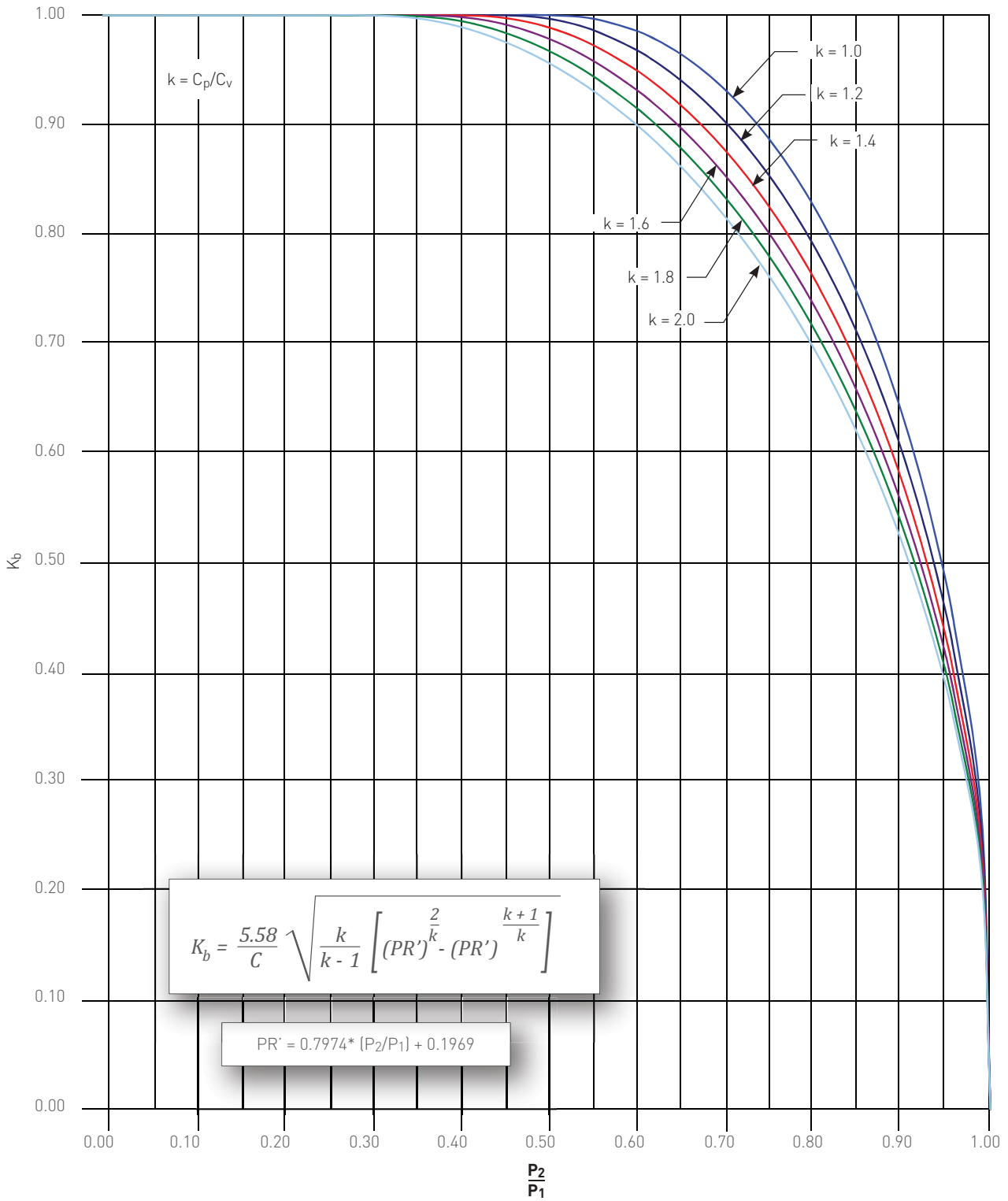


Where:

$P_2$  = Pressure at valve outlet during flow, bara. This is total back pressure (barg) + atmospheric pressure (bara)

$P_1$  = Relieving pressure, bara. This is the set pressure (barg) + overpressure (barg) + atmospheric pressure (bara) - inlet pressure piping loss (barg)

FIGURE 8-21  
 Anderson Greenwood Series 81P (-8 Orifice Only) Balanced Piston Direct Spring PRV Back Pressure Correction Factor ( $K_b$ ) - Gas Service

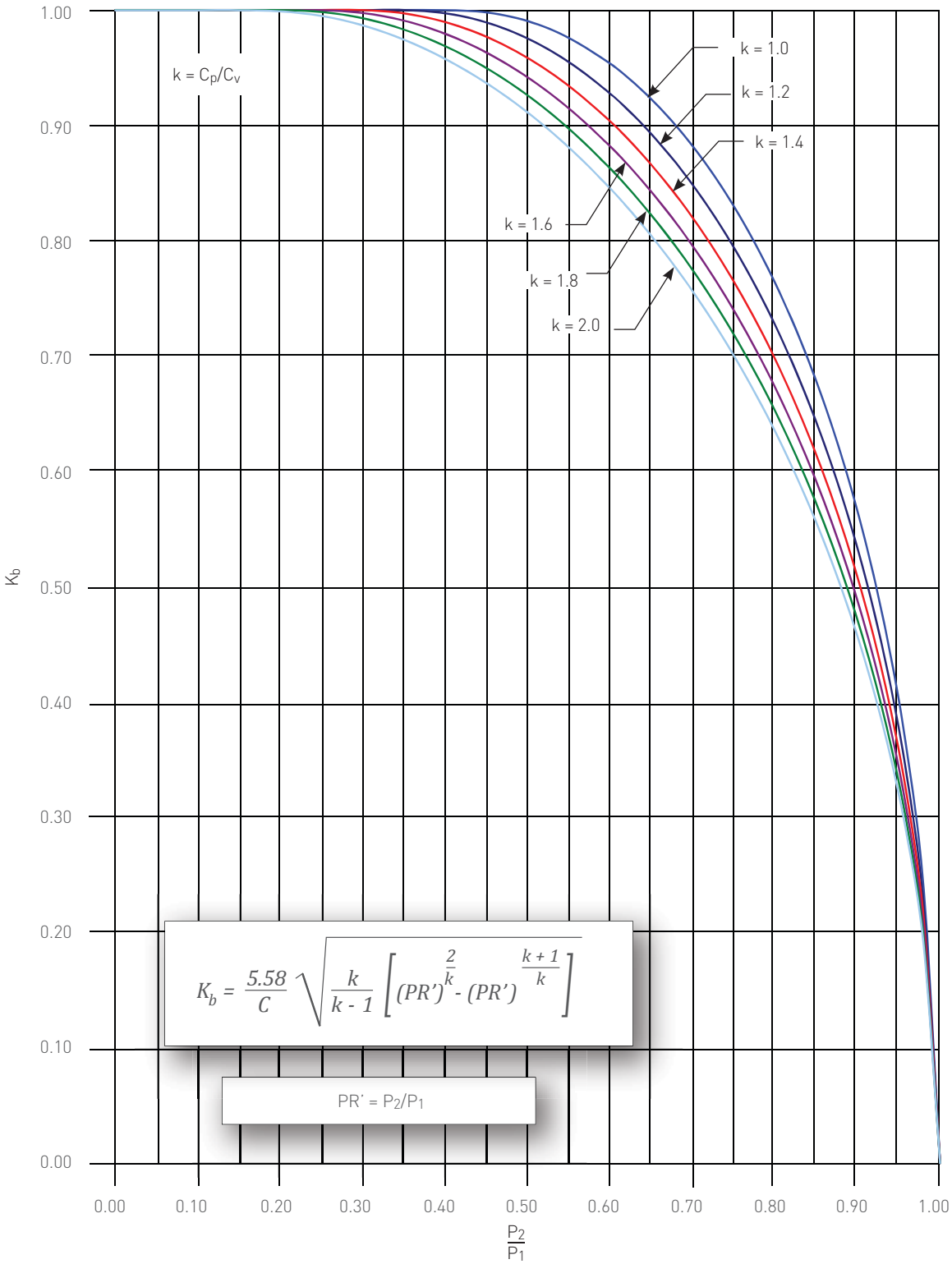


Where:

$P_2$  = Pressure at valve outlet during flow, bara. This is total back pressure (barg) + atmospheric pressure (bara)

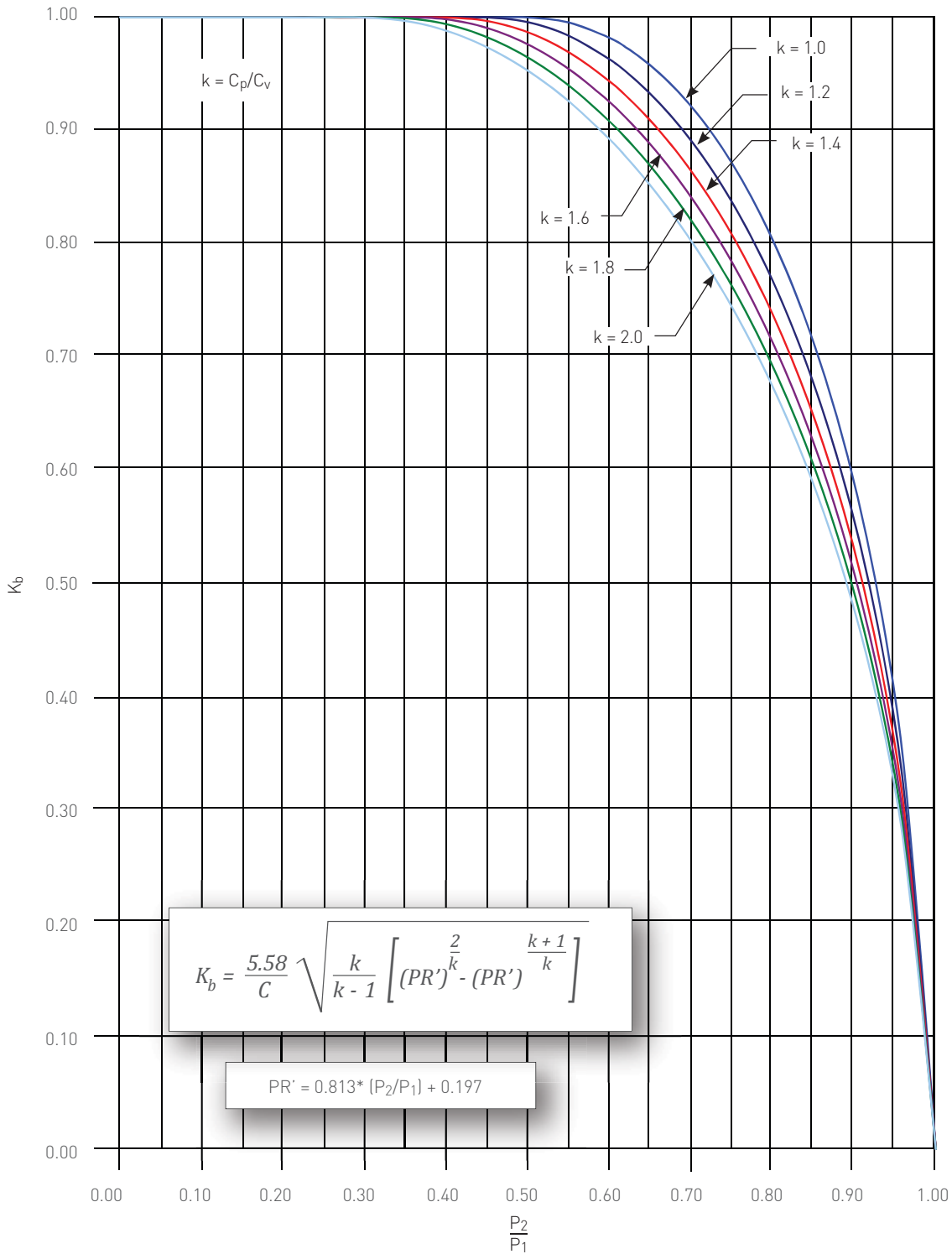
$P_1$  = Relieving pressure, bara. This is the set pressure (barg) + overpressure (barg) + atmospheric pressure (bara) - inlet pressure piping loss (barg)

FIGURE 8-22  
 Anderson Greenwood Series 90/9000 - POPRV Back Pressure Correction Factor ( $K_b$ ) - Gas Service



Where:  
 $P_2$  = Pressure at valve outlet during flow, bara. This is total back pressure (barg) + atmospheric pressure (bara)  
 $P_1$  = Relieving pressure, bara. This is the set pressure (barg) + overpressure (barg) + atmospheric pressure (bara) - inlet pressure piping loss (barg)

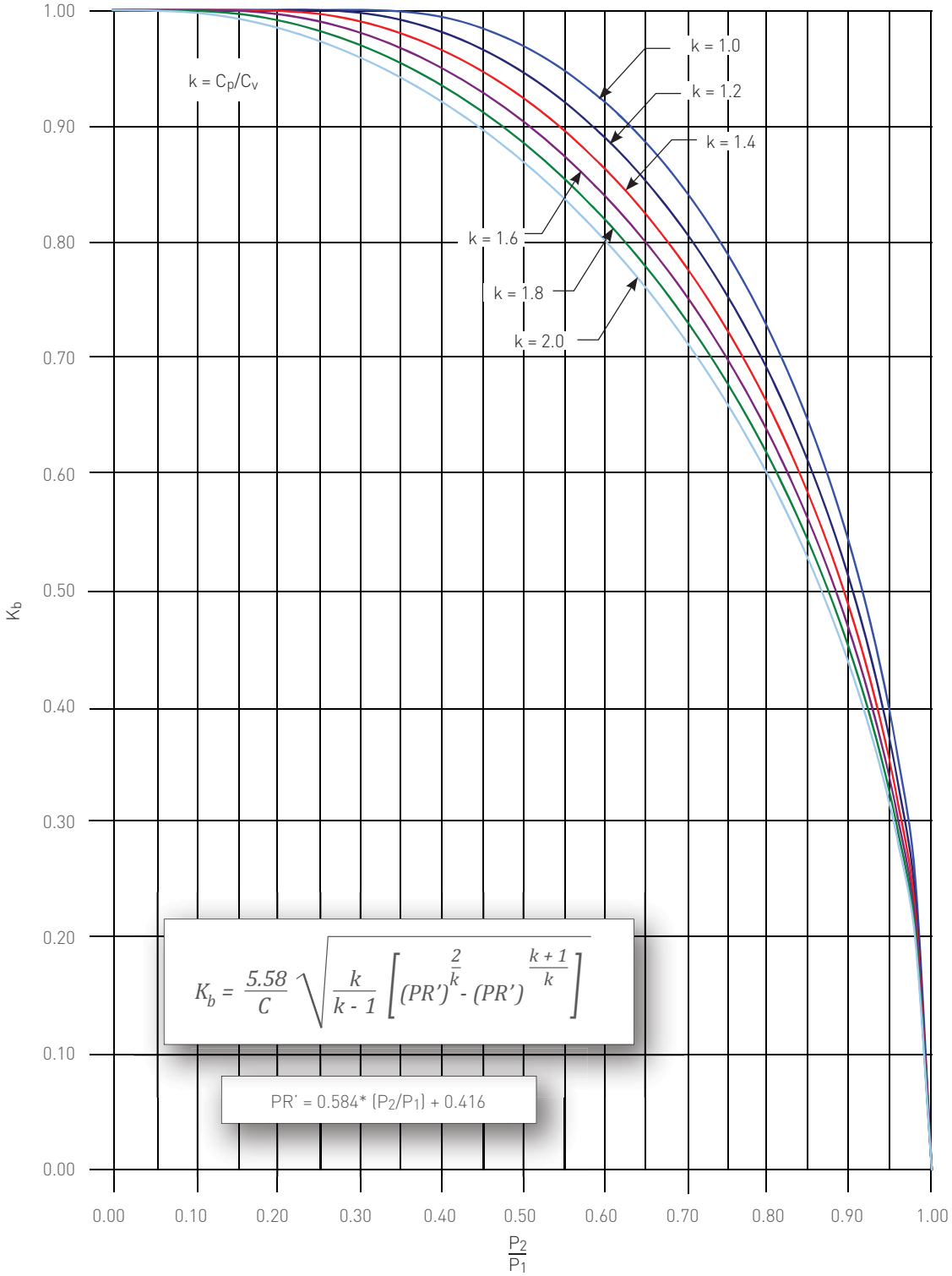
FIGURE 8-23  
 Anderson Greenwood Series 40 Pilot Operated PRV Back Pressure Correction Factor ( $K_b$ ) - Gas/Steam Service



Where:  
 $P_2$  = Pressure at valve outlet during flow, bara. This is total back pressure (barg) + atmospheric pressure (bara)  
 $P_1$  = Relieving pressure, bara. This is the set pressure (barg) + overpressure (barg) + atmospheric pressure (bara) - inlet pressure piping loss (barg)



FIGURE 8-24  
 Anderson Greenwood Series 50 Pilot Operated PRV Back Pressure Correction Factor ( $K_b$ ) - Gas/Steam Service

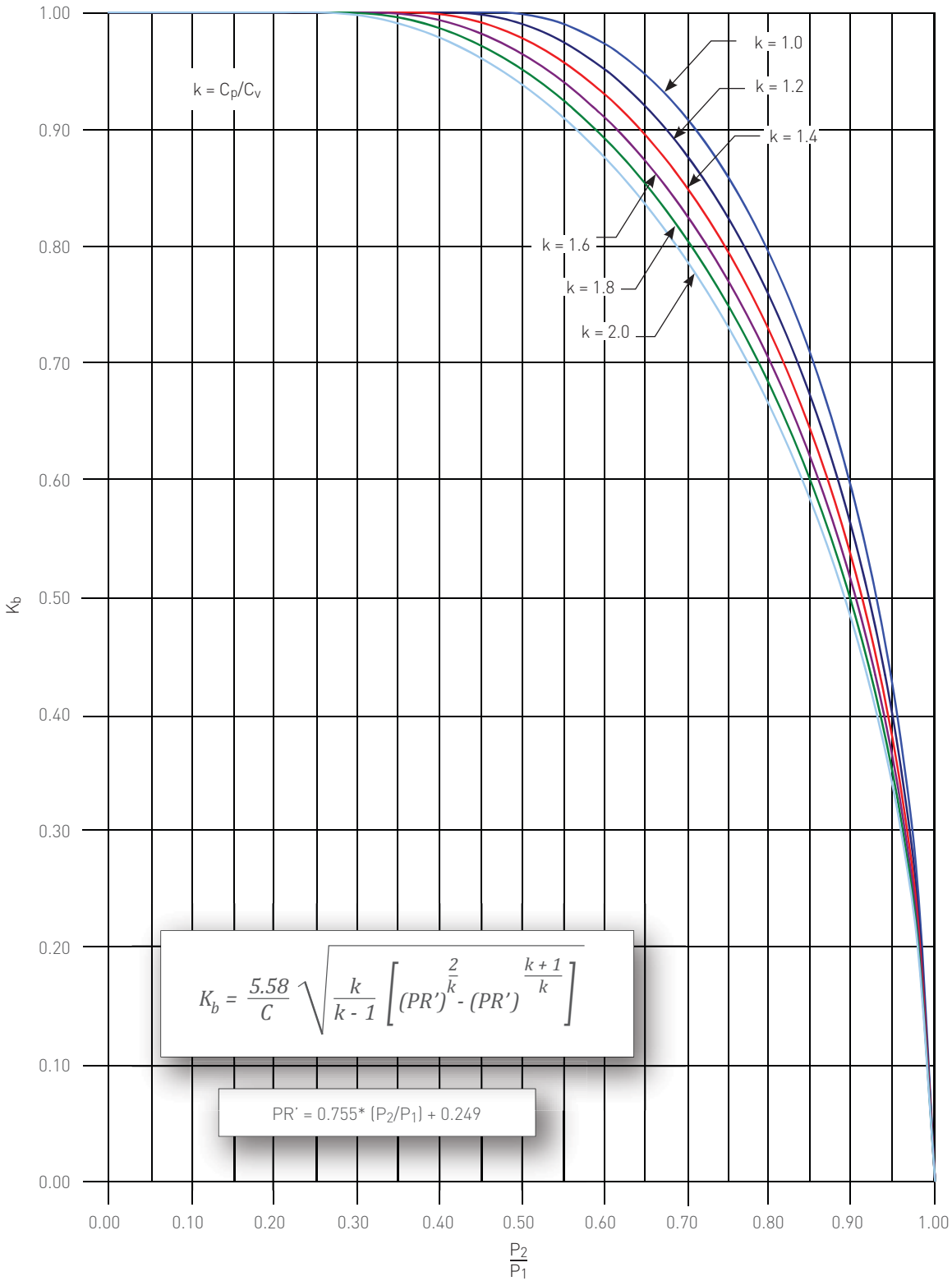


Where:

$P_2$  = Pressure at valve outlet during flow, bara. This is total back pressure (barg) + atmospheric pressure (bara)

$P_1$  = Relieving pressure, bara. This is the set pressure (barg) + overpressure (barg) + atmospheric pressure (bara) - inlet pressure piping loss (barg)

FIGURE 8-25  
 Anderson Greenwood Series 60 Pilot Operated PRV Back Pressure Correction Factor ( $K_b$ ) - Gas/Steam Service

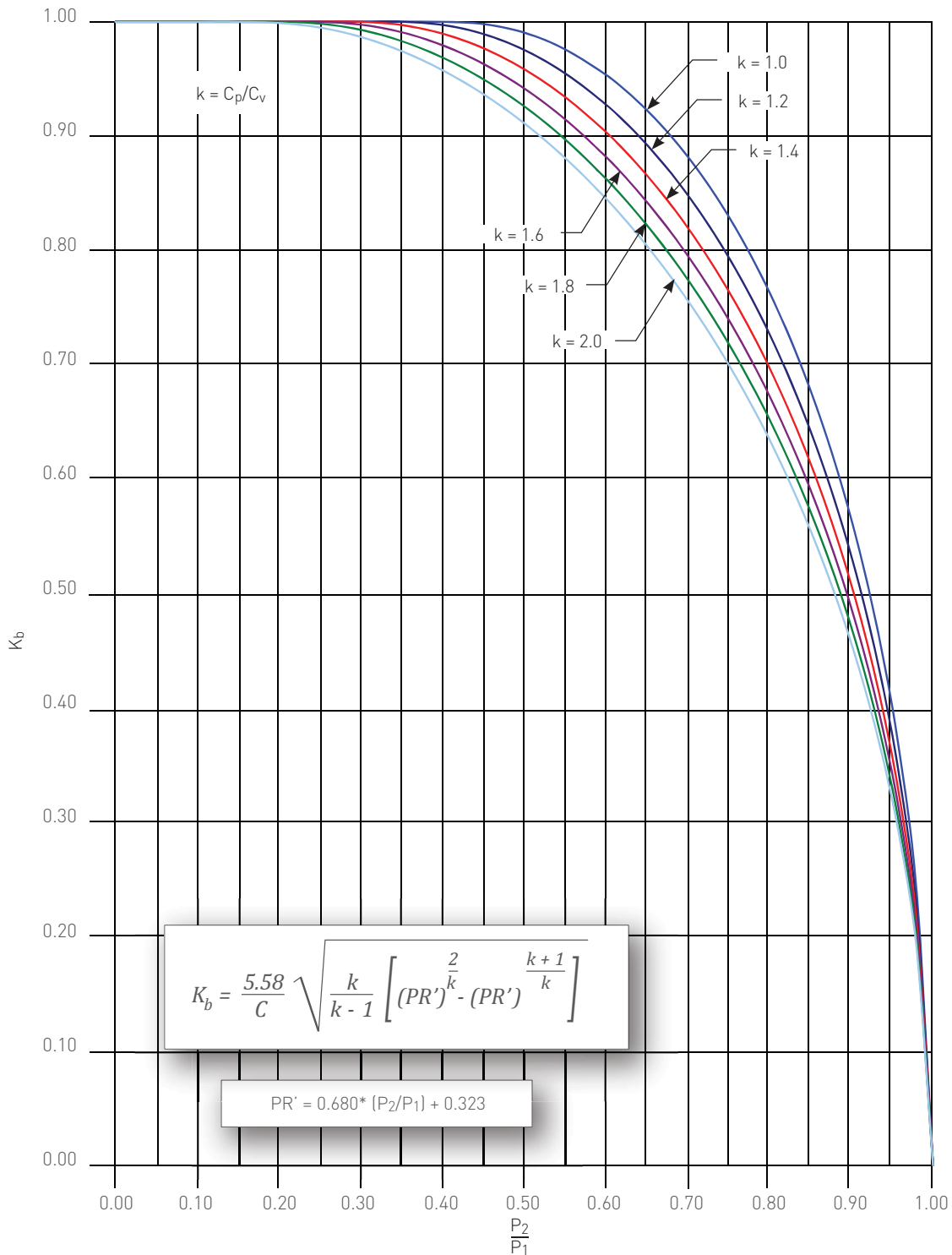


Where:

$P_2$  = Pressure at valve outlet during flow, bara. This is total back pressure (barg) + atmospheric pressure (bara)

$P_1$  = Relieving pressure, bara. This is the set pressure (barg) + overpressure (barg) + atmospheric pressure (bara) - inlet pressure piping loss (barg)

FIGURE 8-26  
 Anderson Greenwood Series LCP Pilot Operated PRV Back Pressure Correction Factor ( $K_b$ ) - Gas Service

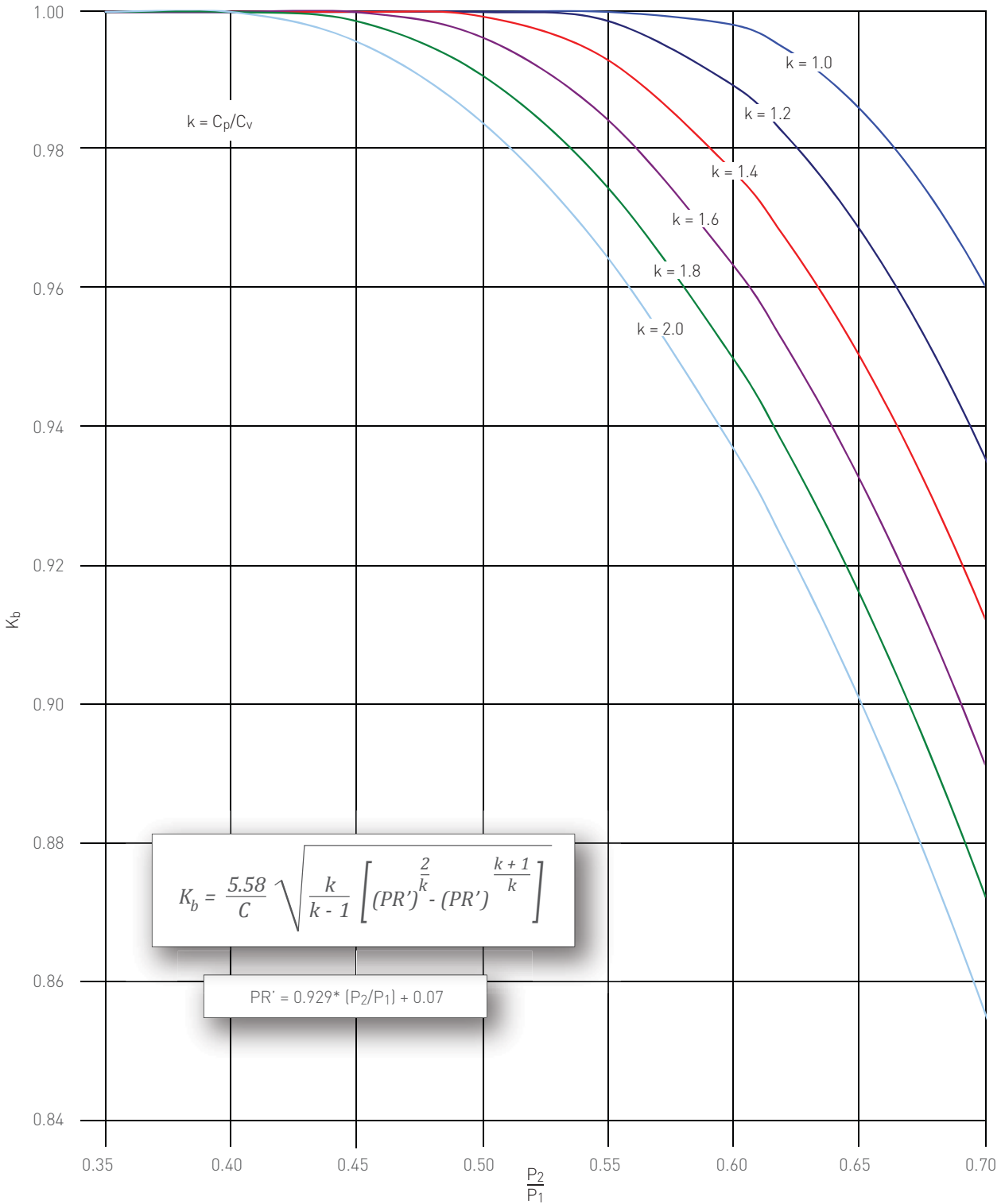


Where:

$P_2$  = Pressure at valve outlet during flow, bara. This is total back pressure (barg) + atmospheric pressure (bara)

$P_1$  = Relieving pressure, bara. This is the set pressure (barg) + overpressure (barg) + atmospheric pressure (bara) - inlet pressure piping loss (barg)

FIGURE 8-27  
 Anderson Greenwood Series 727 Pilot Operated PRV Back Pressure Correction Factor ( $K_b$ ) - Gas/Steam Service



Where:  
 $P_2$  = Pressure at valve outlet during flow, bara. This is total back pressure (barg) + atmospheric pressure (bara)  
 $P_1$  = Relieving pressure, bara. This is the set pressure (barg) + overpressure (barg) + atmospheric pressure (bara) - inlet pressure piping loss (barg)

**III. CAPACITY CORRECTION FACTOR FOR HIGH PRESSURE STEAM,  $K_n$**

The high pressure steam correction factor  $K_n$  is used when steam relieving pressure  $P_1$  is greater than 103.4 bara and less than or equal to 220.6 bara. This factor has been adopted by ASME to account for the deviation between steam flow as determined by Napier’s equation and actual saturated steam flow at high pressures.  $K_n$  may be calculated by the following equation or may be taken from Figure 8-28.

USCS Units:

$$K_n = \frac{2.763P_1 - 1000}{3.324P_1 - 1061}$$

Where:

- $K_n$  = High pressure steam correction factor.
- $P_1$  = Relieving pressure, bara. This is the set pressure + overpressure + atmospheric pressure.

**IV. CAPACITY CORRECTION FACTORS FOR VISCOSITY,  $K_v$**

When a liquid relief valve is required to flow a viscous fluid there may be the occasion to adjust the required orifice area for a laminar flow regime. If the Reynolds Number is less than 100,000 then there will be a viscosity correction factor,  $K_v$ . The procedure to determine the  $K_v$  factor is as follows:

**Step One**

Calculate the minimum required discharge area using the liquid sizing formula in Chapter 5 Section V. Assume the  $K_v$  factor is equal to 1.0.

**Step Two**

Select the actual orifice area that will equal or exceed the minimum area calculated in step one from an appropriate valve in Chapter 8 Section IX in square centimeters.

**Step Three**

Calculate the Reynolds Number.

$$R = \frac{(3,133,300)V_L G}{\mu \sqrt{A'}}$$

Where:

- R = Reynolds Number
- $V_L$  = Required relieving capacity, m<sup>3</sup>/h at flowing temperature
- G = Specific gravity of process fluid at flowing temperature referred to water at standard conditions
- $\mu$  = Absolute viscosity at the flow temperature, centipoises
- $A'$  = Actual orifice area selected in step two, square millimeters

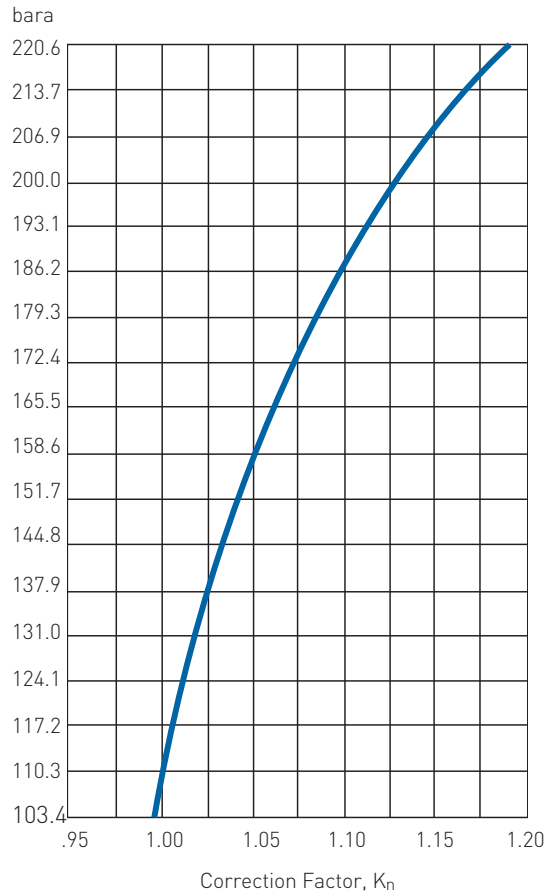
**Step Four**

Use the Reynolds Number from step three and obtain the  $K_v$  factor from Figure 8-29.

**Step Five**

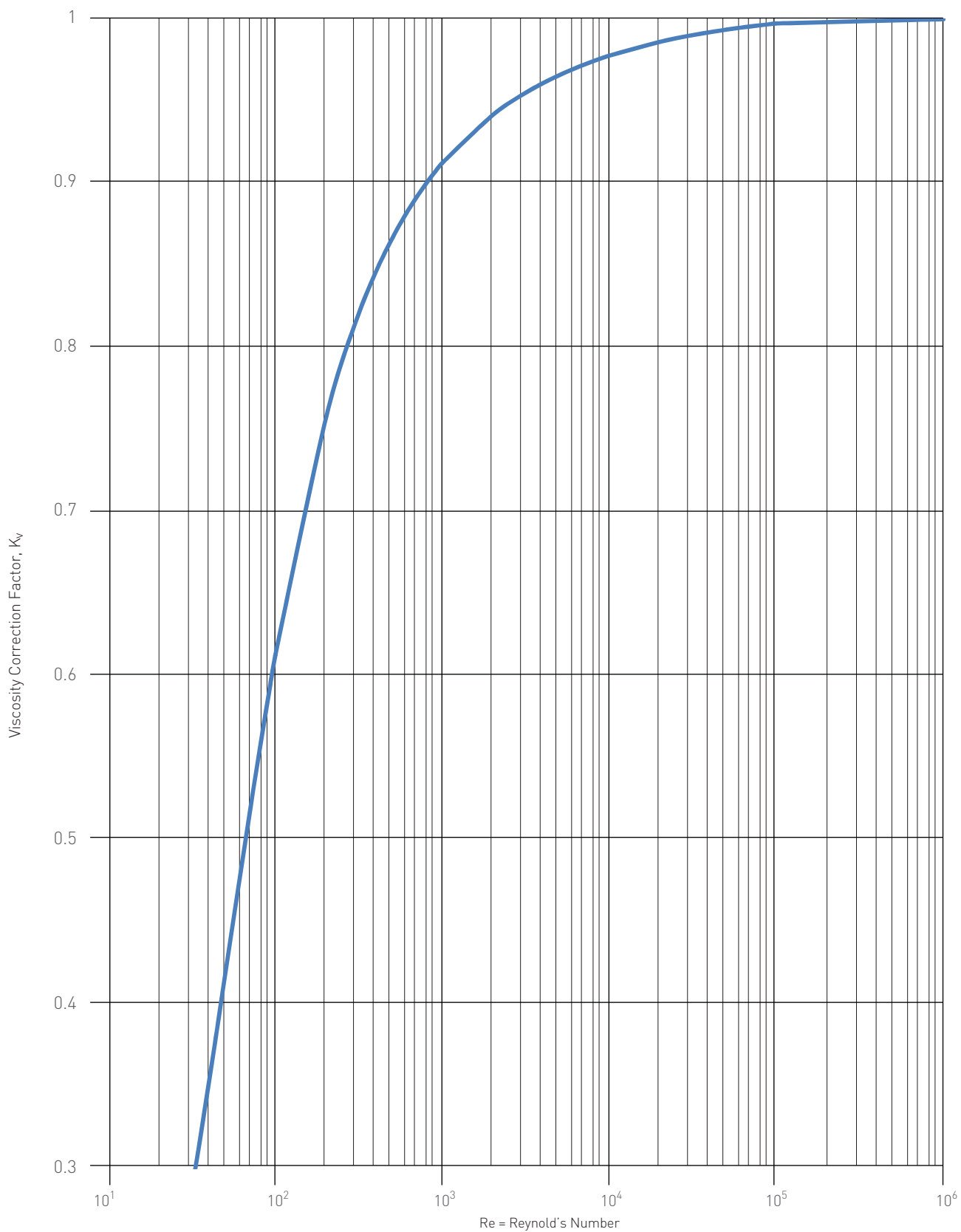
Repeat step one calculation using the  $K_v$  from step four. If the minimum required discharge area is equal to or less than the selected actual orifice area,  $A'$ , from step two, the procedure is complete. If not, chose the next largest available actual orifice area and repeat steps three through five.

FIGURE 8-28  
 Correction Factor for High Pressure Steam,  $K_n$



All Crosby steam capacity charts will reflect the  $K_n$  factor where applicable.

FIGURE 8-29  
Viscosity Correction Factor ( $K_v$ )



# PRESSURE RELIEF VALVE ENGINEERING HANDBOOK

## CHAPTER 8 - ENGINEERING SUPPORT INFORMATION - METRIC UNITS

### V. CAPACITY CORRECTION FACTOR FOR SUPERHEAT, $K_{sh}$

The steam sizing formulas are based on the flow of dry saturated steam. To size for superheated steam, the superheat correction factor is used to correct the calculated saturated steam flow to superheated steam flow. For saturated steam  $K_{sh} = 1.0$ . When the steam is superheated, enter Table 8-1 at the required relieving pressure and read the superheat correction factor under the total steam temperature column.

**TABLE 8-1 - Superheat correction factors**

Flowing pressure (bara)	Total temperature of superheated steam, °C																	
	205	225	250	275	300	325	350	375	400	425	450	475	500	525	550	575	600	625
5.0	0.991	0.968	0.942	0.919	0.896	0.876	0.857	0.839	0.823	0.807	0.792	0.778	0.765	0.752	0.740	0.728	0.717	0.706
7.5	0.995	0.972	0.946	0.922	0.899	0.878	0.859	0.841	0.824	0.808	0.793	0.779	0.766	0.753	0.740	0.729	0.718	0.707
10.0	0.985	0.973	0.950	0.925	0.902	0.880	0.861	0.843	0.825	0.809	0.794	0.780	0.766	0.753	0.741	0.729	0.718	0.707
12.5	0.981	0.976	0.954	0.928	0.905	0.883	0.863	0.844	0.827	0.810	0.795	0.781	0.767	0.754	0.741	0.729	0.718	0.707
15.0	-	-	0.957	0.932	0.907	0.885	0.865	0.846	0.828	0.812	0.796	0.782	0.768	0.755	0.742	0.730	0.718	0.708
17.5	-	-	0.959	0.935	0.910	0.887	0.866	0.847	0.829	0.813	0.797	0.782	0.769	0.756	0.743	0.731	0.719	0.708
20.0	-	-	0.960	0.939	0.913	0.889	0.868	0.849	0.831	0.814	0.798	0.784	0.769	0.756	0.744	0.731	0.720	0.708
22.5	-	-	0.963	0.943	0.916	0.892	0.870	0.850	0.832	0.815	0.799	0.785	0.770	0.757	0.744	0.732	0.720	0.709
25.0	-	-	-	0.946	0.919	0.894	0.872	0.852	0.834	0.816	0.800	0.785	0.771	0.757	0.744	0.732	0.720	0.710
27.5	-	-	-	0.948	0.922	0.897	0.874	0.854	0.835	0.817	0.801	0.786	0.772	0.758	0.745	0.733	0.721	0.710
30.0	-	-	-	0.949	0.925	0.899	0.876	0.855	0.837	0.819	0.802	0.787	0.772	0.759	0.746	0.733	0.722	0.710
32.5	-	-	-	0.951	0.929	0.902	0.879	0.857	0.838	0.820	0.803	0.788	0.773	0.759	0.746	0.734	0.722	0.711
35.0	-	-	-	0.953	0.933	0.905	0.881	0.859	0.840	0.822	0.804	0.789	0.774	0.760	0.747	0.734	0.722	0.711
37.5	-	-	-	0.956	0.936	0.908	0.883	0.861	0.841	0.823	0.806	0.790	0.775	0.761	0.748	0.735	0.723	0.711
40.0	-	-	-	0.959	0.940	0.910	0.885	0.863	0.842	0.824	0.807	0.791	0.776	0.762	0.748	0.735	0.723	0.712
42.5	-	-	-	0.961	0.943	0.913	0.887	0.864	0.844	0.825	0.808	0.792	0.776	0.762	0.749	0.736	0.724	0.713
45.0	-	-	-	-	0.944	0.917	0.890	0.866	0.845	0.826	0.809	0.793	0.777	0.763	0.749	0.737	0.725	0.713
47.5	-	-	-	-	0.946	0.919	0.892	0.868	0.847	0.828	0.810	0.793	0.778	0.764	0.750	0.737	0.725	0.713
50.0	-	-	-	-	0.947	0.922	0.894	0.870	0.848	0.829	0.811	0.794	0.779	0.765	0.751	0.738	0.725	0.714
52.5	-	-	-	-	0.949	0.926	0.897	0.872	0.850	0.830	0.812	0.795	0.780	0.765	0.752	0.738	0.726	0.714
55.0	-	-	-	-	0.952	0.930	0.899	0.874	0.851	0.831	0.813	0.797	0.780	0.766	0.752	0.739	0.727	0.714
57.5	-	-	-	-	0.954	0.933	0.902	0.876	0.853	0.833	0.815	0.798	0.782	0.767	0.753	0.739	0.727	0.715
60.0	-	-	-	-	0.957	0.937	0.904	0.878	0.855	0.834	0.816	0.798	0.783	0.768	0.753	0.740	0.727	0.716
62.5	-	-	-	-	0.960	0.940	0.907	0.880	0.856	0.836	0.817	0.799	0.783	0.768	0.754	0.740	0.728	0.716
65.0	-	-	-	-	0.964	0.944	0.910	0.882	0.859	0.837	0.818	0.801	0.784	0.769	0.754	0.741	0.729	0.716
67.5	-	-	-	-	0.966	0.946	0.913	0.885	0.860	0.839	0.819	0.802	0.785	0.769	0.755	0.742	0.729	0.717
70.0	-	-	-	-	-	0.947	0.916	0.887	0.862	0.840	0.820	0.802	0.786	0.770	0.756	0.742	0.729	0.717
72.5	-	-	-	-	-	0.949	0.919	0.889	0.863	0.842	0.822	0.803	0.787	0.771	0.756	0.743	0.730	0.717
75.0	-	-	-	-	-	0.951	0.922	0.891	0.865	0.843	0.823	0.805	0.788	0.772	0.757	0.744	0.730	0.718
77.5	-	-	-	-	-	0.953	0.925	0.893	0.867	0.844	0.824	0.806	0.788	0.772	0.758	0.744	0.731	0.719
80.0	-	-	-	-	-	0.955	0.928	0.896	0.869	0.846	0.825	0.806	0.789	0.773	0.758	0.744	0.732	0.719
82.5	-	-	-	-	-	0.957	0.932	0.898	0.871	0.847	0.827	0.807	0.790	0.774	0.759	0.745	0.732	0.719
85.0	-	-	-	-	-	0.960	0.935	0.901	0.873	0.849	0.828	0.809	0.791	0.775	0.760	0.746	0.732	0.720
87.5	-	-	-	-	-	0.963	0.939	0.903	0.875	0.850	0.829	0.810	0.792	0.776	0.760	0.746	0.733	0.721
90.0	-	-	-	-	-	0.966	0.943	0.906	0.877	0.852	0.830	0.811	0.793	0.776	0.761	0.747	0.734	0.721
92.5	-	-	-	-	-	0.970	0.947	0.909	0.879	0.853	0.832	0.812	0.794	0.777	0.762	0.747	0.734	0.721
95.0	-	-	-	-	-	0.973	0.950	0.911	0.881	0.855	0.833	0.813	0.795	0.778	0.763	0.748	0.734	0.722
97.5	-	-	-	-	-	0.977	0.954	0.914	0.883	0.857	0.834	0.814	0.796	0.779	0.763	0.749	0.735	0.722
100.0	-	-	-	-	-	0.981	0.957	0.917	0.885	0.859	0.836	0.815	0.797	0.780	0.764	0.749	0.735	0.722
102.5	-	-	-	-	-	0.984	0.959	0.920	0.887	0.860	0.837	0.816	0.798	0.780	0.764	0.750	0.736	0.723

PRESSURE RELIEF VALVE ENGINEERING HANDBOOK  
 CHAPTER 8 - ENGINEERING SUPPORT INFORMATION - METRIC UNITS

TABLE 8-1 - Superheat correction factors (continued)

Flowing pressure (bara)	Total temperature of superheated steam, °C																	
	205	225	250	275	300	325	350	375	400	425	450	475	500	525	550	575	600	625
105.0	-	-	-	-	-	-	0.961	0.923	0.889	0.862	0.838	0.817	0.799	0.781	0.765	0.750	0.737	0.723
107.5	-	-	-	-	-	-	0.962	0.925	0.891	0.863	0.839	0.818	0.799	0.782	0.766	0.751	0.737	0.724
110.0	-	-	-	-	-	-	0.963	0.928	0.893	0.865	0.840	0.819	0.800	0.782	0.766	0.751	0.737	0.724
112.5	-	-	-	-	-	-	0.964	0.930	0.893	0.865	0.840	0.819	0.799	0.781	0.765	0.750	0.736	0.723
115.0	-	-	-	-	-	-	0.964	0.931	0.894	0.865	0.840	0.818	0.798	0.780	0.764	0.749	0.735	0.722
117.5	-	-	-	-	-	-	0.965	0.932	0.894	0.865	0.839	0.817	0.797	0.780	0.763	0.748	0.734	0.721
120.0	-	-	-	-	-	-	0.966	0.933	0.894	0.864	0.839	0.817	0.797	0.779	0.762	0.747	0.733	0.719
122.5	-	-	-	-	-	-	0.967	0.935	0.895	0.864	0.839	0.816	0.796	0.778	0.761	0.746	0.732	0.718
125.0	-	-	-	-	-	-	0.967	0.936	0.896	0.864	0.838	0.816	0.796	0.777	0.760	0.745	0.731	0.717
127.5	-	-	-	-	-	-	0.968	0.937	0.896	0.864	0.838	0.815	0.795	0.776	0.759	0.744	0.729	0.716
130.0	-	-	-	-	-	-	0.969	0.939	0.896	0.864	0.837	0.814	0.794	0.775	0.758	0.743	0.728	0.715
132.5	-	-	-	-	-	-	0.971	0.940	0.897	0.864	0.837	0.813	0.792	0.774	0.757	0.741	0.727	0.713
135.0	-	-	-	-	-	-	0.972	0.942	0.897	0.863	0.837	0.813	0.792	0.773	0.756	0.740	0.725	0.712
140.0	-	-	-	-	-	-	0.976	0.946	0.897	0.863	0.835	0.811	0.790	0.771	0.753	0.737	0.723	0.709
142.5	-	-	-	-	-	-	0.978	0.947	0.898	0.862	0.834	0.810	0.789	0.770	0.752	0.736	0.721	0.707
145.0	-	-	-	-	-	-	-	0.948	0.898	0.862	0.833	0.809	0.787	0.768	0.751	0.734	0.720	0.706
147.5	-	-	-	-	-	-	-	0.948	0.898	0.862	0.832	0.808	0.786	0.767	0.749	0.733	0.719	0.704
150.0	-	-	-	-	-	-	-	0.948	0.899	0.861	0.832	0.807	0.785	0.766	0.748	0.732	0.717	0.703
152.5	-	-	-	-	-	-	-	0.947	0.899	0.861	0.831	0.806	0.784	0.764	0.746	0.730	0.716	0.702
155.0	-	-	-	-	-	-	-	0.947	0.899	0.861	0.830	0.804	0.782	0.763	0.745	0.728	0.714	0.700
157.5	-	-	-	-	-	-	-	0.946	0.899	0.860	0.829	0.803	0.781	0.761	0.743	0.727	0.712	0.698
160.0	-	-	-	-	-	-	-	0.945	0.900	0.859	0.828	0.802	0.779	0.759	0.741	0.725	0.710	0.696
162.5	-	-	-	-	-	-	-	0.945	0.900	0.859	0.827	0.801	0.778	0.757	0.739	0.723	0.708	0.694
165.0	-	-	-	-	-	-	-	0.945	0.900	0.858	0.826	0.799	0.776	0.756	0.738	0.721	0.706	0.692
167.5	-	-	-	-	-	-	-	0.944	0.900	0.857	0.825	0.797	0.774	0.754	0.736	0.719	0.704	0.690
170.0	-	-	-	-	-	-	-	0.944	0.900	0.856	0.823	0.796	0.773	0.752	0.734	0.717	0.702	0.688
172.5	-	-	-	-	-	-	-	0.944	0.900	0.855	0.822	0.794	0.771	0.750	0.732	0.715	0.700	0.686
175.0	-	-	-	-	-	-	-	0.944	0.900	0.854	0.820	0.792	0.769	0.748	0.730	0.713	0.698	0.684
177.5	-	-	-	-	-	-	-	0.944	0.900	0.853	0.819	0.791	0.767	0.746	0.728	0.711	0.696	0.681
180.0	-	-	-	-	-	-	-	0.944	0.901	0.852	0.817	0.789	0.765	0.744	0.725	0.709	0.694	0.679
182.5	-	-	-	-	-	-	-	0.945	0.901	0.851	0.815	0.787	0.763	0.742	0.723	0.706	0.691	0.677
185.0	-	-	-	-	-	-	-	0.945	0.901	0.850	0.814	0.785	0.761	0.739	0.720	0.704	0.689	0.674
187.5	-	-	-	-	-	-	-	0.945	0.901	0.849	0.812	0.783	0.758	0.737	0.718	0.701	0.686	0.671
190.0	-	-	-	-	-	-	-	0.946	0.901	0.847	0.810	0.781	0.756	0.734	0.715	0.698	0.683	0.669
192.5	-	-	-	-	-	-	-	0.948	0.901	0.846	0.808	0.778	0.753	0.732	0.713	0.696	0.681	0.666
195.0	-	-	-	-	-	-	-	0.950	0.900	0.844	0.806	0.776	0.750	0.729	0.710	0.693	0.677	0.663
197.5	-	-	-	-	-	-	-	0.952	0.899	0.842	0.803	0.773	0.748	0.726	0.707	0.690	0.674	0.660
200.0	-	-	-	-	-	-	-	-	0.899	0.840	0.801	0.770	0.745	0.723	0.704	0.687	0.671	0.657
202.5	-	-	-	-	-	-	-	-	0.899	0.839	0.798	0.767	0.742	0.720	0.701	0.683	0.668	0.654
205.0	-	-	-	-	-	-	-	-	0.899	0.837	0.795	0.764	0.738	0.717	0.697	0.680	0.665	0.651
207.5	-	-	-	-	-	-	-	-	0.898	0.834	0.792	0.761	0.735	0.713	0.694	0.677	0.661	0.647
210.0	-	-	-	-	-	-	-	-	0.896	0.832	0.790	0.758	0.732	0.710	0.691	0.673	0.658	0.643
212.5	-	-	-	-	-	-	-	-	0.894	0.829	0.786	0.754	0.728	0.706	0.686	0.669	0.654	0.640
215.0	-	-	-	-	-	-	-	-	0.892	0.826	0.783	0.750	0.724	0.702	0.682	0.665	0.650	0.636
217.5	-	-	-	-	-	-	-	-	0.891	0.823	0.779	0.746	0.720	0.698	0.679	0.661	0.646	0.631
220.0	-	-	-	-	-	-	-	-	0.887	0.820	0.776	0.743	0.716	0.694	0.674	0.657	0.641	0.627



**VI. RATIO OF SPECIFIC HEATS, K, AND COEFFICIENT, C**

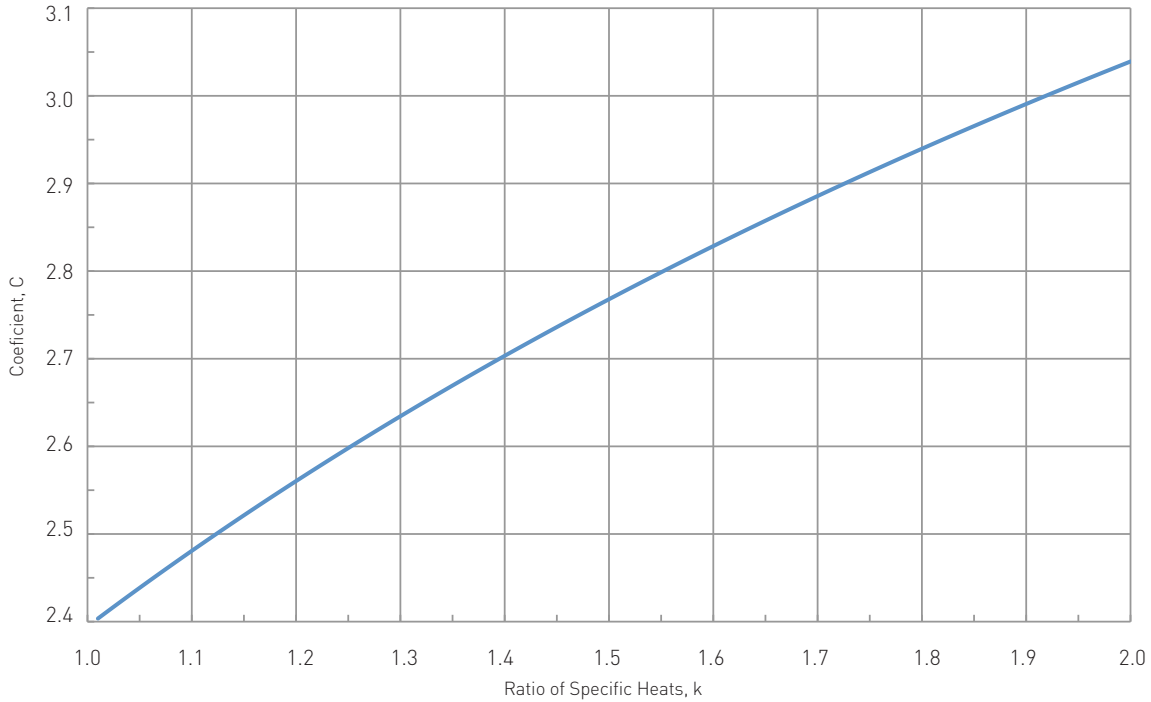
The following formula equates the ratio of specific heats (k) to the coefficient, C, used in sizing methods for gases and vapors. Figure 8-30 and Table 8-2 provide the calculated solution to this formula.

$$C = 3.948 \sqrt{k \left( \frac{2}{k+1} \right)^{\frac{k+1}{k-1}}}$$

Where:

k = Ratio of specific heats

FIGURE 8-30  
 Gas Constant



**TABLE 8-2 - Gas Constant Values**

k	C	k	C	k	C	k	C	k	C
1.01	2.404	1.21	2.568	1.41	2.710	1.61	2.833	1.81	2.945
1.02	2.412	1.22	2.570	1.42	2.717	1.62	2.840	1.82	2.950
1.03	2.421	1.23	2.583	1.43	2.723	1.63	2.846	1.83	2.955
1.04	2.430	1.24	2.591	1.44	2.730	1.64	2.852	1.84	2.960
1.05	2.439	1.25	2.598	1.45	2.736	1.65	2.858	1.85	2.965
1.06	2.447	1.26	2.605	1.46	2.743	1.66	2.863	1.86	2.971
1.07	2.456	1.27	2.613	1.47	2.749	1.67	2.869	1.87	2.976
1.08	2.464	1.28	2.620	1.48	2.755	1.68	2.874	1.88	2.981
1.09	2.472	1.29	2.627	1.49	2.762	1.69	2.880	1.89	2.986
1.10	2.481	1.30	2.634	1.50	2.768	1.70	2.886	1.90	2.991
1.11	2.489	1.31	2.641	1.51	2.774	1.71	2.891	1.91	2.996
1.12	2.497	1.32	2.649	1.52	2.780	1.72	2.897	1.92	3.001
1.13	2.505	1.33	2.656	1.53	2.786	1.73	2.902	1.93	3.006
1.14	2.513	1.34	2.663	1.54	2.793	1.74	2.908	1.94	3.010
1.15	2.521	1.35	2.669	1.55	2.799	1.75	2.913	1.95	3.015
1.16	2.529	1.36	2.676	1.56	2.805	1.76	2.918	1.96	3.020
1.17	2.537	1.37	2.683	1.57	2.811	1.77	2.924	1.97	3.025
1.18	2.545	1.38	2.690	1.58	2.817	1.78	2.929	1.98	3.030
1.19	2.553	1.39	2.697	1.59	2.823	1.79	2.934	1.99	3.034
1.20	2.560	1.40	2.703	1.60	2.829	1.80	2.940	2.00	3.039

**VII. TYPICAL FLUID PROPERTIES**

The specific heat ratios listed herein have been obtained from numerous sources. They may vary from values available to the reader. Exercise caution when selecting the specific heat ratio.

**TABLE 8-3 - Physical Properties for Selected Gases**

Gas	Empirical formula	Molecular weight	Specific heat ratio	Gas constant
		M	k	C
Acetone	C <sub>3</sub> H <sub>6</sub> O	58.08	1.12	2.497
Acetylene (Ethyne)	C <sub>2</sub> H <sub>2</sub>	26.04	1.26	2.605
Air	-	28.97	1.40	2.703
Ammonia, Anhydrous	NH <sub>3</sub>	17.03	1.31	2.641
Argon	Ar	39.95	1.67	2.869
Benzene (Benzol or Benzole)	C <sub>6</sub> H <sub>6</sub>	78.11	1.12	2.497
Boron Trifluoride	BF <sub>3</sub>	67.82	1.2	2.560
Butadiene-1,3 (Divinyl)	C <sub>4</sub> H <sub>6</sub>	54.09	1.12	2.497
Butane (Normal Butane)	C <sub>4</sub> H <sub>10</sub>	58.12	1.09	2.472
Butylene (1-Butene)	C <sub>4</sub> H <sub>8</sub>	56.11	1.11	2.489
Carbon Dioxide	CO <sub>2</sub>	44.01	1.29	2.627
Carbon Disulfide (C. Bisulfide)	CS <sub>2</sub>	76.13	1.21	2.568
Carbon Monoxide	CO	28.01	1.40	2.703
Carbon Tetrachloride	CCl <sub>4</sub>	153.82	1.11	2.489
Chlorine	Cl <sub>2</sub>	70.91	1.36	2.676
Chloromethane (Methyl Chloride)	CH <sub>3</sub> Cl	50.49	1.28	2.620
Cyclohexane	C <sub>6</sub> H <sub>12</sub>	84.16	1.09	2.472
Cyclopropane (Trimethylene)	C <sub>3</sub> H <sub>6</sub>	42.08	1.11	2.489
Decane-n	C <sub>10</sub> H <sub>22</sub>	142.29	1.04	2.430
Diethylene Glycol (DEG)	C <sub>4</sub> H <sub>10</sub> O <sub>3</sub>	106.17	1.07	2.456
Diethyl Ether (Methyl Ether)	C <sub>2</sub> H <sub>6</sub> O	46.07	1.11	2.489
Dowtherm A	-	165.00	1.05	2.439
Dowtherm E	-	147.00	1.00	2.401
Ethane	C <sub>2</sub> H <sub>6</sub>	30.07	1.19	2.553
Ethyl Alcohol (Ethanol)	C <sub>2</sub> H <sub>6</sub> O	46.07	1.13	2.505
Ethylene (Ethene)	C <sub>2</sub> H <sub>4</sub>	28.05	1.24	2.591
Ethylene Glycol	C <sub>2</sub> H <sub>6</sub> O <sub>2</sub>	62.07	1.09	2.472
Ethylene Oxide	C <sub>2</sub> H <sub>4</sub> O	44.05	1.21	2.568
<b>Fluorocarbons:</b>				
12, Dichlorodifluoromethane	CCl <sub>2</sub> F <sub>2</sub>	120.93	1.14	2.513
13, Chlorotrifluoromethane	CClF <sub>3</sub>	104.47	1.17	2.537
13B1, Bromotrifluoromethane	CBrF <sub>3</sub>	148.93	1.14	2.513
22, Chlorodifluoromethane	CHClF <sub>2</sub>	86.48	1.18	2.545
115, Chloropentafluoroethane	C <sub>2</sub> ClF <sub>5</sub>	154.48	1.08	2.464
Glycerine (Glycerin or Glycerol)	C <sub>3</sub> H <sub>8</sub> O <sub>3</sub>	92.10	1.06	2.447

PRESSURE RELIEF VALVE ENGINEERING HANDBOOK  
 CHAPTER 8 - ENGINEERING SUPPORT INFORMATION - METRIC UNITS

**TABLE 8-3 - Physical properties for selected gases (continued)**

Gas	Empirical formula	Molecular weight M	Specific heat ratio k	Gas constant C
Helium	He	4.00	1.67	2.869
Heptane	C <sub>7</sub> H <sub>16</sub>	100.21	1.05	2.439
Hexane	C <sub>6</sub> H <sub>14</sub>	86.18	1.06	2.447
Hydrogen	H <sub>2</sub>	2.02	1.41	2.710
Hydrogen Chloride, Anhydrous	HCl	36.46	1.41	2.710
Hydrogen Sulfide	H <sub>2</sub> S	34.08	1.32	2.649
Isobutane [2-Methylpropane]	C <sub>4</sub> H <sub>10</sub>	58.12	1.10	2.481
Isobutane [2-Methyl-1,3butadiene]	C <sub>5</sub> H <sub>8</sub>	68.12	1.09	2.472
Isopropyl Alcohol [Isopropanol]	C <sub>3</sub> H <sub>8</sub> O	60.10	1.09	2.472
Krypton	Kr	83.80	1.71	2.891
Methane	CH <sub>4</sub>	16.04	1.31	2.641
Methyl Alcohol [Methanol]	CH <sub>4</sub> O	32.04	1.20	2.560
<b>Methylanmines, Anhydrous:</b>				
Monomethylamine (Methylamine)	CH <sub>5</sub> N	31.06	1.02	2.412
Dimethylamine	C <sub>2</sub> H <sub>7</sub> N	45.08	1.15	2.521
Triethylamine	C <sub>3</sub> H <sub>9</sub> N	59.11	1.18	2.545
Methyl Mercaptan (Methylamine)	CH <sub>4</sub> S	48.11	1.20	2.560
Naphthalene (Naphthaline)	C <sub>10</sub> H <sub>8</sub>	128.17	1.07	2.456
Natural Gas (Relative Density = 0.60)	-	17.40	1.27	2.613
Neon	Ne	20.18	1.64	2.852
Nitrogen	N <sub>2</sub>	28.01	1.40	2.703
Nitrous Oxide	N <sub>2</sub> O	44.01	1.30	2.634
Octane	C <sub>8</sub> H <sub>18</sub>	114.23	1.05	2.439
Oxygen	O <sub>2</sub>	32.00	1.40	2.703
Pentane	C <sub>5</sub> H <sub>12</sub>	72.15	1.07	2.456
Propadiene (Allene)	C <sub>3</sub> H <sub>4</sub>	40.07	1.69	2.880
Propane	C <sub>3</sub> H <sub>8</sub>	44.10	1.13	2.505
Propylene (Propene)	C <sub>3</sub> H <sub>6</sub>	42.08	1.15	2.521
Propylene Oxide	C <sub>3</sub> H <sub>6</sub> O	58.08	1.13	2.505
Styrene	C <sub>8</sub> H <sub>8</sub>	104.15	1.07	2.456
Sulfur Dioxide	SO <sub>2</sub>	64.06	1.28	2.620
Sulfur Hexafluoride	SF <sub>6</sub>	146.05	1.09	2.472
Steam	H <sub>2</sub> O	18.02	1.31	2.641
Toluene (Toluol or Methylbenzene)	C <sub>7</sub> H <sub>8</sub>	92.14	1.09	2.472
Triethylene Glycol (TEG)	C <sub>6</sub> H <sub>14</sub> O <sub>4</sub>	150.18	1.04	2.430
Vinyl Chloride Monomer (VCM)	C <sub>2</sub> H <sub>3</sub> Cl	62.50	1.19	2.553
Xenon	Xe	131.30	1.65	2.858
Xylene (p-Xylene)	C <sub>8</sub> H <sub>10</sub>	106.17	1.07	2.456

PRESSURE RELIEF VALVE ENGINEERING HANDBOOK  
 CHAPTER 8 - ENGINEERING SUPPORT INFORMATION - METRIC UNITS

**TABLE 8-4 - Physical Properties for Selected Liquids**

Fluid	Empirical Formula	Relative Density G	Fluid Temperature
		Water = 1	°C
Acetaldehyde	C <sub>2</sub> H <sub>4</sub>	0.779	20
Acetic Acid	C <sub>2</sub> H <sub>4</sub> O <sub>2</sub>	1.051	20
Acetone	C <sub>3</sub> H <sub>6</sub> O	0.792	20
Ammonia, Anhydrous	NH <sub>3</sub>	0.666	20
<b>Automotive Crankcase and Gear Oils:</b>			
SAE-5W Through SAE 150	-	0.88-0.94	15.6
Beer	-	1.01	15.6
Benzene (Benzol)	C <sub>6</sub> H <sub>6</sub>	0.880	20
Boron Trifluoride	BF <sub>3</sub>	1.57	-100
Butadiene-1,3	C <sub>4</sub> H <sub>6</sub>	0.622	20
Butane-n (Normal Butane)	C <sub>4</sub> H <sub>10</sub>	0.579	20
Butylene (1-Butene)	C <sub>4</sub> H <sub>8</sub>	0.600	20
Carbon Dioxide	CO <sub>2</sub>	1.03	-20
Carbon Disulphide (C. Bisulphide)	CS <sub>2</sub>	1.27	20
Carbon Tetrachloride	CCl <sub>4</sub>	1.60	20
Chlorine	Cl <sub>2</sub>	1.42	20
Chloromethane (Methyl Chloride)	CH <sub>3</sub> Cl	0.921	20
<b>Crude Oils:</b>			
32.6 Deg API	-	0.862	15.6
35.6 Deg API	-	0.847	15.6
40 Deg API	-	0.825	15.6
48 Deg API	-	0.79	15.6
Cyclohexane	C <sub>6</sub> H <sub>12</sub>	0.780	20
Cyclopropane (Trimethylene)	C <sub>3</sub> H <sub>6</sub>	0.621	20
Decane-n	C <sub>10</sub> H <sub>22</sub>	0.731	20
Diesel Fuel Oils	-	0.82-0.95	15.6
Diethylene Glycol (DEG)	C <sub>4</sub> H <sub>10</sub> O <sub>3</sub>	1.12	20
Dimethyl Ether (Methyl Ether)	C <sub>2</sub> H <sub>6</sub> O	0.663	20
Dowtherm A	-	0.998	20
Dowtherm E	-	1.087	20
Ethane	C <sub>2</sub> H <sub>6</sub>	0.336	20
Ethyl Alcohol (Ethanol)	C <sub>2</sub> H <sub>6</sub> O	0.79	20
Ethylene (Ethene)	C <sub>2</sub> H <sub>4</sub>	0.569	-104
Ethylene Glycol	C <sub>2</sub> H <sub>6</sub> O <sub>2</sub>	1.115	20
Ethylene Oxide	C <sub>2</sub> H <sub>4</sub> O	0.901	20
<b>Fluorocarbons:</b>			
R12, Dichlorodifluoromethane	CCl <sub>2</sub> F <sub>2</sub>	1.34	20
R13, Chlorotrifluoromethane	CClF <sub>3</sub>	0.916	20
R13B1, Bromotrifluoromethane	CBrF <sub>3</sub>	1.58	20
R22, Chlorodifluoromethane	CHClF <sub>2</sub>	1.21	20
R115, Chloropentafluoroethane	C <sub>2</sub> ClF <sub>5</sub>	1.31	20
Fuel Oils, Nos. 1, 2, 3, 5 and 6	-	0.82-0.95	15.6

PRESSURE RELIEF VALVE ENGINEERING HANDBOOK  
CHAPTER 8 - ENGINEERING SUPPORT INFORMATION - METRIC UNITS

**TABLE 8-4 - Physical Properties for Selected Liquids (continued)**

Fluid	Empirical formula	Relative Density G:	Fluid Temperature
		Water = 1	°C
Gasolines	-	0.68-0.74	15.6
Glycerine (Glycerin or Glycerol)	C <sub>3</sub> H <sub>8</sub> O <sub>3</sub>	1.26	20
Heptane	C <sub>7</sub> H <sub>16</sub>	0.685	20
Hexane	C <sub>6</sub> H <sub>14</sub>	0.660	20
Hydrochloric Acid	HCl	1.64	15.6
Hydrogen Sulphide	H <sub>2</sub> S	0.78	20
Isobutane (2-Methylpropane)	C <sub>4</sub> H <sub>10</sub>	0.558	20
Isoprene (2-Methyl-1,3-Butadiene)	C <sub>5</sub> H <sub>8</sub>	0.682	20
Isopropyl Alcohol (Isopropanol)	C <sub>3</sub> H <sub>8</sub> O	0.786	20
Jet Fuel (average)	-	0.82	15.6
Kerosene	-	0.78-0.82	15.6
Methyl Alcohol (Methanol)	CH <sub>4</sub> O	0.792	20
<b>Methylamines, Anhydrous:</b>			
Monomethylamine (Methylamine)	CH <sub>5</sub> N	0.663	20
Dimethylamine	C <sub>2</sub> H <sub>7</sub> N	0.656	20
Trimethylamine	C <sub>3</sub> H <sub>9</sub> N	0.634	20
Methyl Mercaptan (Methanethiol)	CH <sub>4</sub> S	0.870	20
Nitric Acid	HNO <sub>3</sub>	1.5	15.6
Nitrous Oxide	N <sub>2</sub> O	1.23	-88.5
Octane	C <sub>8</sub> H <sub>18</sub>	0.703	20
Pentane	C <sub>5</sub> H <sub>12</sub>	0.627	20
Propadiene (Allene)	C <sub>3</sub> H <sub>4</sub>	0.659	-34.4
Propane	C <sub>3</sub> H <sub>8</sub>	0.501	20
Propylene (Propene)	C <sub>3</sub> H <sub>6</sub>	0.514	20
Propylene Oxide	C <sub>3</sub> H <sub>6</sub> O	0.830	20
Styrene	C <sub>8</sub> H <sub>8</sub>	0.908	20
Sulfur Dioxide	SO <sub>2</sub>	1.43	20
Sulphur Hexafluoride	SF <sub>6</sub>	1.37	20
<b>Sulphur Acid:</b>			
95-100%	-	1.839	20
60%	-	1.50	20
20%	-	1.14	20
Toluene (Toluol or Methylbenzene)	C <sub>7</sub> H <sub>8</sub>	0.868	20
Triethylene Glycol (TEG)	C <sub>6</sub> H <sub>12</sub> O <sub>4</sub>	1.126	20
Vinyl Chloride Monomer (VCM)	C <sub>2</sub> H <sub>3</sub> Cl	0.985	-20
Water, fresh	H <sub>2</sub> O	1.00	20
Water, sea	-	1.03	20
Xylene (p-Xylene)	C <sub>8</sub> H <sub>10</sub>	0.862	20

**VIII. SATURATED STEAM PRESSURE TABLE**

**TABLE 8-5 - Saturation Pressure (bara)/Temperature (°C)**

Pressure bara	Temperature deg C	Pressure bara	Temperature deg C
1.01	100.0	35.9	243.9
1.03	100.7	37.2	246.1
1.38	108.9	38.6	248.2
1.72	115.6	40.0	250.3
2.07	121.3	41.4	252.3
2.41	126.3	42.7	254.3
2.76	130.7	44.1	256.2
3.10	134.7	45.5	258.1
3.45	138.3	46.9	259.9
3.79	141.7	48.3	261.7
4.14	144.8	49.6	263.4
4.48	147.8	51.0	265.2
4.83	150.5	52.4	266.8
5.17	153.1	53.8	268.5
5.52	155.6	55.2	270.1
5.86	157.9	56.5	271.7
6.21	160.2	57.9	273.3
6.55	162.3	59.3	274.8
6.90	165.3	60.7	276.3
7.24	166.3	62.1	277.8
7.58	168.2	63.4	279.2
7.93	170.1	64.8	280.6
8.27	171.8	66.2	282.1
8.62	173.6	67.6	283.4
8.96	175.2	69.0	284.8
9.31	176.8	72.4	288.1
9.65	178.3	75.8	291.3
10.00	179.9	79.3	294.3
10.30	181.3	82.7	297.3
11.00	184.2	86.2	300.2
11.70	186.9	89.6	303.0
12.40	189.5	93.1	305.7
13.10	191.9	96.5	308.4
13.80	194.3	100.0	310.9
14.50	196.6	103.0	313.4
15.20	198.8	110.0	318.3
15.90	200.9	117.0	322.8
16.50	203.0	124.0	327.2
17.20	205.0	131.0	331.4
17.90	206.9	137.0	335.4
18.60	208.8	144.0	339.3
19.30	210.6	151.0	343.1
20.00	212.4	158.0	346.6
20.70	214.1	165.0	350.1
22.10	217.4	172.0	353.4
23.40	220.6	179.0	356.6
24.80	223.8	186.0	359.7
26.20	226.4	193.0	362.8
27.60	229.2	200.0	365.7
29.00	231.9	207.0	368.5
30.30	234.0	213.0	371.3
31.70	236.9	220.0	373.9
33.10	239.3	221.0	374.2
34.50	241.7		

### IX. ANDERSON GREENWOOD AND CROSBY PRESSURE RELIEF VALVES

---

#### Orifice Area and Coefficient of Discharge

As mentioned in Chapter Three and Six, the use of the proper orifice area (A) and coefficient of discharge (K) in the sizing formulas presented in this handbook are critical to determining the correct valve size. For some valve designs, two sets of values are published.

One set, the effective area and effective coefficient of discharge, are published by API in Standard 526, Flanged Steel Pressure Relief Valves and Standard 520 part I, Sizing, Selection and Installation of Pressure Relieving Devices. These values are independent of any specific valve design and are used to determine a preliminary pressure relief valve size. The "effective" coefficient of discharge is 0.975 for gases, vapors and steam, and 0.650 for liquids.

Where applicable, a second set of areas and discharge coefficients is used to determine the "rated" capacity of a valve using the "actual" orifice area and "rated" coefficient of discharge.

Rated coefficients are established by regulatory bodies like ASME and "actual" areas are published by the manufacturer.

It is important to remember that the effective area and effective coefficient of discharge are used only for the initial selection. The actual orifice area and rated coefficient of discharge must always be used to verify the actual capacity of the pressure relief valve.

*In no case should an effective area or effective coefficient of discharge be used with actual area or rated coefficient of discharge. Sizing errors can be made if the effective values are mixed with the actual values.*

The following tables provide orifice areas and coefficient of discharge for Anderson Greenwood and Crosby pressure relief valves. Once again, where applicable, there is a table with API "effective" values and a separate table with ASME "rated" and "actual" values.

*Do not mix values from these tables.*

**TABLE 8-6 - JOS-E/JBS-E/JLT-E Full Nozzle Direct Acting Spring Valves**

API Effective Orifice Area and Coefficient of Discharge				
Minimum inlet size mm	Orifice designation	Gas (mm <sup>2</sup> )	Liquid (mm <sup>2</sup> )	Steam (mm <sup>2</sup> )
		Series	Series	Series
		JOS-E, JBS-E, JLT-JOS-E, JLT-JBS-E K = 0.975	JLT-JOS-E, JLT-JBS-E K = 0.650	JOS-E, JBS-E K = 0.975
25	D	71.00	71.00	71.00
25	E	126.50	126.50	126.50
40	F	198.10	198.10	198.10
40	G	324.50	324.50	324.50
40	H	506.50	506.50	506.50
50	J	830.30	830.30	830.30
80	K	1186.00	1186.00	1186.00
80	L	1841.00	1841.00	1841.00
100	M	2333.00	2333.00	2333.00
100	N	2800.00	2800.00	2800.00
100	P	4116.00	4116.00	4116.00
150	Q	7129.00	7129.00	7129.00
150	R	10320.00	10320.00	10320.00
200	T	16770.00	16770.00	16770.00

**TABLE 8-7 - JOS-E/JBS-E/JLT-E Full Nozzle Direct Acting Spring Valves**

ASME Actual Orifice Area and Rated Coefficient of Discharge					
Minimum inlet size mm	Orifice designation	Air/gas (mm <sup>2</sup> )	Air/gas (mm <sup>2</sup> )	Liquid (mm <sup>2</sup> )	Steam (mm <sup>2</sup> )
		Series	Series	Series	Series
		JOS-E, JBS-E K = 0.865	JLT-JOS-E, JLT-JBS-E K = 0.870	JLT-JOS-E, JLT-JBS-E K = 0.656	JOS-E, JBS-E K = 0.865
25	D	80.00	80.00	80.00	80.00
25	E	142.80	142.80	142.80	142.80
40	F	223.90	223.90	223.90	223.90
40	G	366.10	366.10	366.10	366.10
40	H	572.20	572.20	572.20	572.20
50	J	937.40	937.40	937.40	937.40
80	K	1339.00	1339.00	1339.00	1339.00
80	L	2078.00	2078.00	2078.00	2078.00
100	M	2622.00	2622.00	2622.00	2622.00
100	N	3161.00	3161.00	3161.00	3161.00
100	P	4649.00	4649.00	4649.00	4649.00
150	Q	8046.00	8046.00	8046.00	8046.00
150	R	11650.00	11650.00	11650.00	11650.00
200	T	18940.00	18940.00	18940.00	18940.00
200	T2	20300.00	20300.00	20300.00	20300.00



**TABLE 8-8 - OMNI 800/900/BP Portable Direct Acting Spring Valves**

Minimum Inlet Size mm		Orifice Designation		ASME Actual Orifice Area and Rated Coefficient of Discharge							
				Gas (mm <sup>2</sup> )			Liquid (mm <sup>2</sup> )		Steam (mm <sup>2</sup> )		
				Section VIII			Section VIII		Section VIII		
		Series 800 K = 0.877	Series 900 K = 0.878	Series BP K = 0.841	Series 900 K = 0.662	Series BP K = 0.631	Series 800 K = 0.877	Series 900 K = 0.878			
15	-5	-	54.84	-	54.84	-	-	54.84			
15	-6	-	80.20	-	80.20	-	-	80.20			
18	-5	-	-	60.00	-	60.00	-	-			
18	-6	80.20	-	87.74	-	87.74	80.20	-			
25	-7	141.90	141.90	-	141.90	-	141.90	141.90			
40	-8	222.00	223.90	-	223.90	-	222.00	223.90			
40	-9	366.10	366.10	-	366.10	-	366.10	366.10			

**TABLE 8-9 - Series 60 and Series 80 Portable Direct Acting Spring Valves**

Minimum Inlet Size mm		Orifice Designation		ASME Actual Orifice Area and Rated Coefficient of Discharge							
				Gas (mm <sup>2</sup> )				Liquid (mm <sup>2</sup> )	Steam (mm <sup>2</sup> )		
				Section VIII				Section VIII	Section VIII		
		81/83 K = 0.816	81P K = 0.816	61 K = 0.877	63B K = 0.847	81P K = 0.720	86 K = 0.816				
15	-4	31.61	-	-	-	-	31.61				
15	-5	-	-	-	49.03	-	-				
15	-6	71.00	-	71.00	-	-	-				
18	-4	-	-	-	-	31.61	31.61				
18	-7	-	-	-	96.17	-	-				
18	-8	126.50	126.5	-	-	126.50	126.50				
40	F	198.10	-	-	-	-	-				
40	G	324.50	-	-	-	324.50	-				
50	H	506.50	-	-	-	-	-				
50	J	830.30	-	-	-	830.30	830.30				

**TABLE 8-10 - H SERIES DIRECT ACTING SPRING SAFETY VALVES**

ASME Actual Orifice Area and Rated Coefficient of Discharge				
Minimum Inlet size mm	Orifice Designation	Steam (mm <sup>2</sup> )		
		Section I/Section VIII		
		HSJ K = 0.878	HCI ISOFLEX K = 0.878	HE ISOFLEX K = 0.877
30	F	-	-	-
30	G	-	-	-
40	F	198.1	-	-
40	G	324.5	-	-
40	H	506.5	-	-
40	H2	-	641.3	-
40	J	-	-	-
50	H	506.5	-	-
50	J	830.3	-	-
50	J2	-	923.2	-
50	K	-	-	-
60	K	1186.0	-	1186
60	K2	-	1642.0	1642
60	L	-	-	-
80	K	1186.0	-	-
80	L	1841.0	-	-
80	L2	-	2156.0	-
80	M	2323.0	-	2323
80	M <sup>2</sup>	-	2565.0	2565
100	N	2800.0	-	-
100	P	4116.0	-	-
100	P2	-	4561.0	4559
150	Q	7129.0	-	-
150	Q2	-	7903.0	-
150	R	-	10320.0	-
150	RR	-	12440.0	-

**TABLE 8-11 - High Pressure Pilot Operated Valves**

API Effective Orifice Area and Coefficient of Discharge								
Minimum Inlet mm	Orifice Designation	Gas (mm <sup>2</sup> )			Liquid (mm <sup>2</sup> )		Steam (mm <sup>2</sup> )	
		Series			Series		Series	
		200/400/800 K = 0.975	500 K = 0.975	727 K = 0.975	400/800 K = 0.650	500 K = 0.650	500 K = 0.975	727 K = 0.975
25	D	71.0	-	-	71.0	-	-	-
25	E	126.5	-	-	126.5	-	-	-
25	F	198.1	198.1	-	198.1	198.1	198.1	-
40	G	324.5	-	-	324.5	-	-	-
40	H	506.5	506.5	-	506.5	506.5	506.5	-
50	G	324.5	-	324.5	324.5	-	-	324.5
50	H	506.5	-	506.5	506.5	-	-	506.5
50	J	830.3	830.3	830.3	830.3	830.3	830.3	830.3
80	K	1186.0	-	1186.0	1186.0	-	-	1186.0
80	L	1841.0	1841.0	1841.0	1841.0	1841.0	1841.0	1841.0
100	M	2323.0	-	2323.0	2323.0	-	-	2323.0
100	N	2800.0	-	2800.0	2800.0	-	-	2800.0
100	P	4116.0	4116.0	4116.0	4116.0	4116.0	4116.0	4116.0
150	Q	7129.0	-	7129.0	7129.0	-	-	7129.0
150	R	10320.0	10320.0	10320.0	10320.0	10320.0	10320.0	10320.0
200	T	16770.0	16770.0	16770.0	16770.0	16770.0	16770.0	16770.0

PRESSURE RELIEF VALVE ENGINEERING HANDBOOK  
 CHAPTER 8 - ENGINEERING SUPPORT INFORMATION - METRIC UNITS

**TABLE 8-12 - High Pressure Pilot Operated Valves**

ASME Actual Orifice Area and Rated Coefficient of Discharge										
Min. Inlet Size	Orifice Designation	Gas				Liquid		Steam		Economizer
		Section VIII				Section VIII		Section VIII		Section I
		200/400/800	500	LCP	727	400/800	500	500	727	5100
25	D	A = 132.2 mm <sup>2</sup> K = 0.627	-	-	-	A = 142.6 mm <sup>2</sup> K = 0.491	-	-	-	-
25	E	A = 229.7 mm <sup>2</sup> K = 0.627	-	-	-	A = 229.7 mm <sup>2</sup> K = 0.491	-	-	-	-
25	F	A = 230.3 mm <sup>2</sup> K = 0.877	-	-	-	A = 230.3 mm <sup>2</sup> K = 0.766	-	-	-	-
25	-	-	-	A = 506.4 mm <sup>2</sup> K = 0.860	-	-	-	-	-	-
40	G	A = 536.1 mm <sup>2</sup> K = 0.627	-	-	-	A = 587.7 mm <sup>2</sup> K = 0.491	-	-	-	-
40	H	A = 589.0 mm <sup>2</sup> K = 0.877	A = 589.0 mm <sup>2</sup> K = 0.877	-	-	A = 589.0 mm <sup>2</sup> K = 0.766	A = 589.0 mm <sup>2</sup> K = 0.766	A = 589.0 mm <sup>2</sup> K = 0.877	-	A = 589.0 mm <sup>2</sup> K = 0.876 (steam) K = 0.759 (water)
40	-	-	-	A = 1140 mm <sup>2</sup> K = 0.860	-	-	-	-	-	-
40	FB	A = 965.2 mm <sup>2</sup> K = 0.860	A = 965.2 mm <sup>2</sup> K = 0.860	-	-	A = 965.2 mm <sup>2</sup> K = 0.712	A = 965.2 mm <sup>2</sup> K = 0.712	A = 965.2 mm <sup>2</sup> K = 0.860	-	A = 965.2 mm <sup>2</sup> K = 0.849 (steam) K = 0.709 (water)
50	G	A = 548.4 mm <sup>2</sup> K = 0.627	-	-	A = 405.8 mm <sup>2</sup> K = 0.788	A = 648.4 mm <sup>2</sup> K = 0.491	-	-	A = 405.8 mm <sup>2</sup> K = 0.788	-
50	H	A = 846.4 mm <sup>2</sup> K = 0.627	-	-	A = 632.9 mm <sup>2</sup> K = 0.788	A = 964.5 mm <sup>2</sup> K = 0.491	-	-	A = 632.9 mm <sup>2</sup> K = 0.788	-
50	J	A = 965.2 mm <sup>2</sup> K = 0.877	A = 965.2 mm <sup>2</sup> K = 0.877	-	A = 1055 mm <sup>2</sup> K = 0.788	A = 965.2 mm <sup>2</sup> K = 0.766	A = 965.2 mm <sup>2</sup> K = 0.766	A = 965.2 mm <sup>2</sup> K = 0.877	A = 1055 mm <sup>2</sup> K = 0.788	A = 965.2 mm <sup>2</sup> K = 0.876 (steam) K = 0.759 (water)
50	-	-	-	A = 2027 mm <sup>2</sup> K = 0.860	-	-	-	-	-	-
50	FB	A = 1868 mm <sup>2</sup> K = 0.860	A = 1868 mm <sup>2</sup> K = 0.860	-	-	A = 1868 mm <sup>2</sup> K = 0.712	A = 1868 mm <sup>2</sup> K = 0.712	A = 1868 mm <sup>2</sup> K = 0.860	-	A = 1868 mm <sup>2</sup> K = 0.849 (steam) K = 0.709 (water)
80	J	A = 1376 mm <sup>2</sup> K = 0.627	-	-	-	A = 1661 mm <sup>2</sup> K = 0.491	-	-	-	-
80	K	A = 1963 mm <sup>2</sup> K = 0.627	-	-	A = 1482 mm <sup>2</sup> K = 0.788	A = 2137 mm <sup>2</sup> K = 0.491	-	-	A = 1482 mm <sup>2</sup> K = 0.788	-
80	L	A = 2140 mm <sup>2</sup> K = 0.877	A = 2140 mm <sup>2</sup> K = 0.877	-	A = 2295 mm <sup>2</sup> K = 0.788	A = 2140 mm <sup>2</sup> K = 0.766	A = 2140 mm <sup>2</sup> K = 0.766	A = 2140 mm <sup>2</sup> K = 0.877	A = 2295 mm <sup>2</sup> K = 0.788	A = 2140 mm <sup>2</sup> K = 0.876 (steam) K = 0.759 (water)
80	-	-	-	A = 4561 mm <sup>2</sup> K = 0.860	-	-	-	-	-	-
80	FB	A = 4344 mm <sup>2</sup> K = 0.860	A = 4344 mm <sup>2</sup> K = 0.860	-	-	A = 4344 mm <sup>2</sup> K = 0.712	A = 4344 mm <sup>2</sup> K = 0.712	A = 4344 mm <sup>2</sup> K = 0.860	-	A = 4344 mm <sup>2</sup> K = 0.849 (steam) K = 0.709 (water)
100	L	A = 3051 mm <sup>2</sup> K = 0.627	-	-	-	A = 3685 mm <sup>2</sup> K = 0.491	-	-	-	-
100	M	A = 3845 mm <sup>2</sup> K = 0.627	-	-	A = 2906 mm <sup>2</sup> K = 0.788	A = 4119 mm <sup>2</sup> K = 0.491	-	-	A = 2906 mm <sup>2</sup> K = 0.788	-
100	N	A = 4637 mm <sup>2</sup> K = 0.627	-	-	A = 3500 mm <sup>2</sup> K = 0.788	A = 4554 mm <sup>2</sup> K = 0.491	-	-	A = 3500 mm <sup>2</sup> K = 0.788	-
100	P	A = 4932 mm <sup>2</sup> K = 0.877	A = 4932 mm <sup>2</sup> K = 0.877	-	A = 5104 mm <sup>2</sup> K = 0.788	A = 4561 mm <sup>2</sup> K = 0.766	A = 4561 mm <sup>2</sup> K = 0.766	A = 4932 mm <sup>2</sup> K = 0.877	A = 5104 mm <sup>2</sup> K = 0.788	-
100	FB	A = 6941 mm <sup>2</sup> K = 0.860	A = 6941 mm <sup>2</sup> K = 0.860	-	-	A = 6941 mm <sup>2</sup> K = 0.712	A = 6941 mm <sup>2</sup> K = 0.712	A = 6941 mm <sup>2</sup> K = 0.860	-	A = 6941 mm <sup>2</sup> K = 0.849 (steam) K = 0.709 (water)

**TABLE 8-12 - High Pressure Pilot Operated Valves (continued)**

ASME Actual Orifice Area and Rated Coefficient of Discharge										
Min. Inlet Size	Orifice Designation	Gas				Liquid		Steam		Economizer
		Section VIII				Section VIII		Section VIII		Section I
		200/400/800	500	LCP	727	400/800	500	500	727	5100
150	Q	A = 11800 mm <sup>2</sup> K = 0.627	-	-	A = 8912 mm <sup>2</sup> K = 0.788	A = 10250 mm <sup>2</sup> K = 0.491	-	-	A = 8912 mm <sup>2</sup> K = 0.788	-
150	R	A = 12000 mm <sup>2</sup> K = 0.877	A = 12000 mm <sup>2</sup> K = 0.877	-	A = 12900 mm <sup>2</sup> K = 0.788	A = 10260 mm <sup>2</sup> K = 0.766	A = 10260 mm <sup>2</sup> K = 0.766	A = 12000 mm <sup>2</sup> K = 0.877	A = 10260 mm <sup>2</sup> K = 0.788	-
150	FB	A = 15050 mm <sup>2</sup> K = 0.860	A = 15050 mm <sup>2</sup> K = 0.860	-	-	A = 15050 mm <sup>2</sup> K = 0.712	A = 15050 mm <sup>2</sup> K = 0.712	A = 15050 mm <sup>2</sup> K = 0.860	-	A = 15050 mm <sup>2</sup> K = 0.849 (steam) K = 0.709 (water)
150	T	A = 19730 mm <sup>2</sup> K = 0.877	A = 19730 mm <sup>2</sup> K = 0.877	-	A = 20970 mm <sup>2</sup> K = 0.788	A = 18240 mm <sup>2</sup> K = 0.766	A = 18240 mm <sup>2</sup> K = 0.766	A = 19730 mm <sup>2</sup> K = 0.877	A = 20970 mm <sup>2</sup> K = 0.788	-
150	8FB 8x8	A = 20750 mm <sup>2</sup> K = 0.860	A = 20750 mm <sup>2</sup> K = 0.860	-	-	A = 20110 mm <sup>2</sup> K = 0.712	A = 20110 mm <sup>2</sup> K = 0.712	A = 20750 mm <sup>2</sup> K = 0.860	-	-
150	8FB 10	A = 28500 mm <sup>2</sup> K = 0.860	A = 28500 mm <sup>2</sup> K = 0.860	-	-	A = 28500 mm <sup>2</sup> K = 0.712	A = 28500 mm <sup>2</sup> K = 0.712	A = 28500 mm <sup>2</sup> K = 0.860	-	A = 28500 mm <sup>2</sup> K = 0.849 (steam) K = 0.709 (water)
200	FB	A = 46460 mm <sup>2</sup> K = 0.860	A = 46460 mm <sup>2</sup> K = 0.860	-	-	-	-	A = 46460 mm <sup>2</sup> K = 0.860	-	-

**TABLE 8-13 - LOW PRESSURE PILOT OPERATED VALVES**

ASME Actual Orifice Area and Rated Coefficient of Discharge (Set pressure ≥ 1.03 barg)					
Min. Inlet Size mm	Orifice Designation	Gas (mm <sup>2</sup> )			
		91/94 K = 0.770	93 K = 0.845	95 K = 0.852	9300 K = 0.629
50	*	1884	1477	1890	2161
80	*	4026	3329	4032	4768
100	*	6666	5639	6658	8213
150	*	14340	12620	14290	18640
200	*	25530	23480	-	32260
250	*	36610	32900	-	50870
300	*	57980	54190	-	72900

**TABLE 8-14 - LOW PRESSURE PILOT OPERATED VALVES**

Actual Orifice Area and Rated Coefficient of Discharge (Set pressure < 1.03 barg)						
Min. Inlet Size mm	Orifice Designation	Gas (mm <sup>2</sup> )				
		91/94 K <sub>d</sub> = 0.678 (P <sub>2</sub> /P <sub>1</sub> ) <sup>-0.285</sup>	93 K <sub>d</sub> = 0.700 (P <sub>1</sub> /P <sub>2</sub> ) <sup>-0.265</sup>	95 K <sub>d</sub> = 0.678 (P <sub>1</sub> /P <sub>2</sub> ) <sup>-0.285</sup>	9200 K <sub>d</sub> = 0.756 (P <sub>1</sub> /P <sub>2</sub> ) <sup>0.0517</sup>	9300 K <sub>d</sub> = 0.650 (P <sub>1</sub> /P <sub>2</sub> ) <sup>-0.349</sup>
50	*	1884	1477	1890	2161	2161
80	*	4026	3329	4032	4768	4763
100	*	6666	5639	6653	8213	8213
150	*	14340	12620	14290	18640	18640
200	*	25530	23480	-	32260	32260
250	*	36610	32900	-	50870	50870
300	*	57980	54190	-	72900	72900

\* Full bore

Where:

P<sub>2</sub> = Pressure at valve outlet during flow, bara. This is total back pressure (barg) + atmospheric pressure (bara).

P<sub>1</sub> = Relieving pressure, bara. This is the set pressure (barg) + overpressure (barg) + atmospheric pressure (bara) - inlet pressure piping loss (barg).

P<sub>A</sub> = Atmospheric pressure (bara).

**TABLE 8-15 - Low Pressure Pilot Operated Valves**

Minimum Inlet Size		Air/Gas (mm <sup>2</sup> )	
mm	Orifice Designation	9200	9300
		K <sub>d</sub> = 0.667	K <sub>d</sub> = 0.55
50	*	2161	2161
80	*	4768	4768
100	*	8213	8213
150	*	18640	18640
200	*	32260	32260
250	*	50870	50870
300	*	72900	72900

\* Full bore

**TABLE 8-16 - JB-TD Direct Acting Spring Valves**

ASME Actual Orifice Area and Rated Coefficient of Discharge		Air/Gas/Steam (mm <sup>2</sup> )
Inlet x Outlet Size mm	Orifice Designation	JB-TD
		K = 0.856
10x14	V	30870
12x16	W	44450
12x16	W <sub>1</sub>	46450
14x18	Y	60500
16x18	Z	66550
16x18	Z <sub>1</sub>	70970
16x20	Z <sub>2</sub>	79660
18x24	AA	100000
20x24	BB	123500

PRESSURE RELIEF VALVE ENGINEERING HANDBOOK  
 CHAPTER 8 - ENGINEERING SUPPORT INFORMATION - METRIC UNITS

**X. EQUIVALENTS AND CONVERSION FACTORS**

**TABLE 8-17 - Equivalents and Conversion Factors**

<b>A</b>	<b>B</b>	<b>C</b>
<b>Multiply</b>	<b>By</b>	<b>Obtain</b>
Atmospheres	14.70	Pounds per square inch
Atmospheres	1.033	Kilograms per sq. cm
Atmospheres	29.92	Inches of mercury
Atmospheres	760.0	Millimeters of mercury
Atmospheres	407.5	Inches of water
Atmospheres	33.96	Feet of water
Atmospheres	1.013	Bars
Atmospheres	101.3	Kilo Pascals
Barrels	42.00	Gallons (U.S.)
Bars	14.50	Pounds per square inch
Bars	1.020	Kilograms per sq. cm
Bars	100.0	Kilo Pascals
Centimeters	0.3937	Inches
Centimeters	0.03281	Feet
Centimeters	0.010	Meters
Centimeters	0.01094	Yards
Cubic centimeters	0.06102	Cubic inches
Cubic feet	7.481	Gallons
Cubic feet	0.1781	Barrels
Cubic feet per minute	0.02832	Cubic meters per minute
Cubic feet per second	448.8	Gallons per minute
Cubic inches	16.39	Cubic centimeters
Cubic inches	0.004329	Gallons
Cubic meters	264.2	Gallons
Cubic meters per hour	4.403	Gallons per minute
Cubic meters per minute	35.31	Cubic feet per minute
Standard cubic feet per min.	60.00	Standard cubic ft. per hr
Standard cubic feet per min.	1440.0	Standard cubic ft. per day
Standard cubic feet per min.	0.02716	Nm <sup>3</sup> /min. (0°C, 1 Bara)
Standard cubic feet per min.	1.630	Nm <sup>3</sup> /hr. (0°C, 1 Bara)
Standard cubic feet per min.	39.11	Nm <sup>3</sup> /day (0°C, 1 Bara)
Standard cubic feet per min.	0.02832	Nm <sup>3</sup> /min
Standard cubic feet per min.	1.699	Nm <sup>3</sup> /hr
Standard cubic feet per min.	40.78	Nm <sup>3</sup> /day
Feet	0.3048	Meters
Feet	0.3333	Yards
Feet	30.48	Centimeters
Feet of water (68°F)	0.8812	Inches of mercury (0°C)
Feet of water (68°F)	0.4328	Pounds per square inch
Gallons (U.S.)	3785.0	Cubic centimeters
Gallons (U.S.)	0.1337	Cubic feet
Gallons (U.S.)	231.0	Cubic inches
Gallons (Imperial)	277.4	Cubic inches
Gallons (U.S.)	0.8327	Gallons (Imperial)
Gallons (U.S.)	3.785	Liters
Gallons of water (60°F)	8.337	Pounds
Gallons of liquid	500 x Sp. Gr.	Pounds per hour liquid per minute
Gallons per minute	0.002228	Cubic feet per second
Gallons per minute (60°F)	227.0 x SG	Kilograms per hour
Gallons per minute	0.06309	Liters per second
Gallons per minute	3.785	Liters per minute
Gallons per minute	0.2271	M <sup>3</sup> /hr
Grams	0.03527	Ounces
Inches	2.540	Centimeters
Inches	0.08333	Feet
Inches	0.0254	Meters
Inches	0.02778	Yards

**NOTES**

This table may be used in two ways:

1. **Multiply** the unit under column A by the figure under column B, the result is the unit under column C.
2. **Divide** the unit under column C by the figure under column B, the result is then the unit under column A.

PRESSURE RELIEF VALVE ENGINEERING HANDBOOK  
 CHAPTER 8 - ENGINEERING SUPPORT INFORMATION - METRIC UNITS

**TABLE 8-17 - Equivalents and Conversion Factors (continued)**

<b>A</b>	<b>B</b>	<b>C</b>
<b>Multiply</b>	<b>By</b>	<b>Obtain</b>
Inches of mercury (0°C)	1.135	Feet of water (68°F)
Inches of mercury (0°C)	0.4912	Pounds per square inch
Inches of mercury (0°C)	0.03342	Atmospheres
Inches of mercury (0°C)	0.03453	Kilograms per sq. cm
Inches of water (68°F)	0.03607	Pounds per sq. in.
Inches of water (68°F)	0.07343	Inches of mercury (0°C)
Kilograms	2.205	Pounds
Kilograms	0.001102	Short tons (2000 lbs.)
Kilograms	35.27	Ounces
Kilograms per minute	132.3	Pounds per hour
Kilograms per sq. cm	14.22	Pounds per sq. in.
Kilograms per sq. cm	0.9678	Atmospheres
Kilograms per sq. cm	28.96	Inches of mercury
Kilograms per cubic meter	0.0624	Pounds per cubic foot
Kilo Pascals	0.1450	Pounds per sq. in.
Kilo Pascals	0.0100	Bars
Kilo Pascals	0.01020	Kilograms per sq. cm
Liters	0.03531	Cubic feet
Liters	1000.0	Cubic centimeters
Liters	0.2642	Gallons
Liters per hour	0.004403	Gallons per minute
Meters	3.281	Feet
Meters	1.094	Yards
Meters	100.0	Centimeters
Meters	39.37	Inches
Pounds	0.1199	Gallons H <sub>2</sub> O at 60°F (U.S.)
Pounds	453.6	Grams
Pounds	0.0005	Short tons (2000 lbs.)
Pounds	0.4536	Kilograms
Pounds	0.0004536	Metric tons
Pounds	16.00	Ounces
Pounds per hour	6.324/M.W.	SCFM
Pounds per hour	0.4536	Kilograms per hour
Pounds per hour liquid	0.002/Sp.Gr.	Gallons per minute liquid (at 60°F)
Pounds per sq. inch	27.73	Inches of water (68°F)
Pounds per sq. inch	2.311	Feet of water (68°F)
Pounds per sq. inch	2.036	Inches of mercury (0°C)
Pounds per sq. inch	0.07031	Kilograms per sq. cm
Pounds per sq. inch	0.0680	Atmospheres
Pounds per sq. inch	51.71	Millimeters of mercury (0°C)
Pounds per sq. inch	0.7043	Meters of water (68°F)
Pounds per sq. inch	0.06895	Bar
Pounds per sq. inch	6.895	Kilo Pascals
Specific gravity (of gas or vapors)	28.97	Molecular weight (of gas or vapors)
Square centimeter	0.1550	Square inch
Square inch	6.4516	Square centimeter
Square inch	645.16	Square millimeter
SSU	0.2205 x SG	Centipoise
SSU	0.2162	Centistoke
Water (cubic feet at 60°F)	62.37	Pounds
Temperature:		
Centigrade	=	5/9 (Fahrenheit -32)
Kelvin	=	Centigrade + 273
Fahrenheit	=	9/5 (Centigrade) +32
Fahrenheit	=	Rankine -460
Fahrenheit	=	(9/5 Kelvin) -460

**NOTES**

This table may be used in two ways:

1. **Multiply** the unit under column A by the figure under column B, the result is the unit under column C.
2. **Divide** the unit under column C by the figure under column B, the result is then the unit under column A.

**CONVERSION FACTORS**

**TABLE 8-18 - Pressure Conversions<sup>[1]</sup>**

Given	To Find (To find desired value, multiply "Given" value by factor below)									
	mm wc	mbar	mm Hg	in wc	oz	kPa	in Hg	psig	kg/cm <sup>2</sup>	bars
mm wc (mm water column) (60°F or 15.6°C)	-	0.0980	0.735	0.0394	0.0227	0.00980	0.00290	0.001421	$\frac{1}{10010}$	$\frac{1}{10207}$
mbar (millibars)	10.21	-	0.750	0.4019	0.2320	0.1000	0.0296	0.01450	0.00102	0.00100
mm Hg <sup>[2]</sup> (mm Mercury) (32°F or 0°C)	13.61	1.333	-	0.5358	0.3094	0.1333	0.03948	0.01934	0.00136	0.00133
in wc (in. water column) (60°F or 15.6°C)	25.40	2.488	1.866	-	0.5775	0.2488	0.0737	0.03609	0.00254	0.00249
oz (oz/in <sup>2</sup> )	43.99	4.309	3.232	1.732	-	0.4309	0.1276	0.0625 or 1/16	0.00439	0.00431
kPa (kilopascal)	102.1	10.00	7.501	4.019	2.321	-	0.2961	0.1450	0.0102	0.0100
in Hg (in. Mercury) (60°F or 15.6°C)	344.7	33.77	25.33	13.57	7.836	3.377	-	0.4898	0.0344	0.0338
psig (lbs/in <sup>2</sup> )	703.8	68.95	51.72	27.71	16.00	6.895	2.042	-	0.0703	0.0689
kg/cm <sup>2</sup>	10010	980.7	735.6	394.1	227.6	98.07	29.04	14.22	-	0.9807
bars	10207	1000	750.1	401.9	232.1	100.0	29.61	14.50	1.020	-

**NOTES**

1. When pressure is stated in liquid column height, conversions are valid only for listed temperature.
2. Also expressed as torr.
3. Normal Temperature and Pressure (NTP) conditions, are at sea level, equal to 1.013 bars (absolute) or 1.033 kg/cm<sup>2</sup> (kilograms force per square centimeter absolute) at base temperature of 0°C. This differs slightly from Metric Standard conditions, (MSC), which uses 15°C for the base temperature.



**CONVERSION FACTORS**

**TABLE 8-19 - Gas Flow Conversions**

Given	Notes	To Find (To find desired value, multiply "Given" value by factor below)					
		scfm	scfh	lb/hr	kg/hr	Nm <sup>3</sup> /hr	Nm <sup>3</sup> /min
scfm	[1]	-	60	$\frac{M}{6.32}$	$\frac{M}{13.93}$	1.608	0.0268
scfh	[1]	0.01677	-	$\frac{M}{379.2}$	$\frac{M}{836.1}$	0.0268	0.000447
lb/hr	[2]	$\frac{6.32}{M}$	$\frac{379.2}{M}$	-	0.4536	$\frac{10.17}{M}$	$\frac{0.1695}{M}$
kg/hr	[3]	$\frac{13.93}{M}$	$\frac{836.1}{M}$	2.205	-	$\frac{22.40}{M}$	$\frac{0.3733}{M}$
Nm <sup>3</sup> /hr	[4]	0.6216	37.30	$\frac{M}{10.17}$	$\frac{M}{22.40}$	-	0.01667
Nm <sup>3</sup> /min	[4]	37.30	2238	5.901 M	2.676 M	60	-

**NOTES**

- M = molecular weight of gas.
- Volumetric flow (per time unit of hour or minute as shown) in standard cubic feet per minute at 14.7 psia, 60°F.
  - Weight flow in pounds per hour.
  - Weight flow in kilograms per hour.
  - Volumetric flow (per time unit of hour or minute as shown) at 1.013 bars absolute, 0°C. This represents the commercial standard, known as the Normal Temperature and Pressure (NTP).

Conversions from volumetric to volumetric or to weight flow (and vice versa) may only be done when the volumetric flow is expressed in the standard conditions shown above. If flows are expressed at temperature or pressure bases that differ from those listed above, they must first be converted to the standard base.

If flow is expressed in actual volume, such as m<sup>3</sup>/hr (cubic meters per hour) as is often done for compressors, where the flow is described as displacement or swept volume, the flow may be converted to Nm<sup>3</sup>/hr as follows.

**USCS UNITS**

$$Nm^3/hr = m^3/hr \times \frac{1.013 + p}{1.013} \times \frac{273}{273 + t}$$

Where:

p= gauge pressure of gas in barg

t= temperature of gas in °C

m<sup>3</sup>/hr= displacement or swept volume in cubic meters/hour

PRESSURE RELIEF VALVE ENGINEERING HANDBOOK  
 CHAPTER 8 - ENGINEERING SUPPORT INFORMATION - METRIC UNITS

**CONVERSION FACTORS**

**TABLE 8-20 - LIQUID FLOW CONVERSIONS**

Given	To Find (To find desired value, multiply "Given" value by factor below)				
	l/hr	gpm (US)	gpm (Imp)	barrels/ day	m <sup>3</sup> /hr
l/hr liters/hour	-	0.00440	0.003666	0.1510	0.0010
gpm (US) US gallons per minute	227.1	-	0.8327	34.29	0.2271
gpm (Imp) Imperial gallons per minute	272.8	1.201	-	41.18	0.2728
barrels/day (petroleum) (42 US gallons)	6.624	0.02917	0.02429	-	0.006624
m <sup>3</sup> /hr cubic meters per hour	1000	4.403	3.666	151.0	-
m <sup>3</sup> /s cubic meters per second	3.6 x 10 <sup>6</sup>	15.850	13.200	543.400	3600
kg/hr kilograms per hour	$\frac{1}{G}$	$\frac{1}{227.1G}$	$\frac{1}{272.8G}$	$\frac{0.151}{G}$	$\frac{1}{1000G}$
lb/hr pounds per hour	$\frac{1}{2.205G}$	$\frac{1}{500.8G}$	$\frac{1}{601.5G}$	$\frac{1}{14.61G}$	$\frac{1}{2205G}$

**NOTE**

G = relative density of liquid at its relieving temperature to that of water at 20°C where G<sub>water</sub> = 1.00.

**CONVERSION FACTORS**

**Viscosity Units and Their Conversion**

When a correction for the effects of viscosity in the liquid orifice sizing formula is needed, the value of viscosity, expressed in centipoise, is required. Since most liquid data for viscosity uses other expressions, a convenient method for conversion is presented below.

The viscosity,  $\mu$  (Greek mu), in centipoise, is correctly known as absolute or dynamic viscosity. This is related to the kinematic viscosity expression,  $\nu$  (Greek nu), in centistokes as follows:

$$\mu = \nu \times G$$

Where:

- $\mu$  = absolute viscosity, centipoise
- $\nu$  = kinematic viscosity, centistokes
- G = relative density (water = 1.00)

Most other viscosity units in common usage are also kinematic units and can be related to the kinematic viscosity in centistokes, via the accompanying table. To use this table, obtain the viscosity from data furnished. Convert this to  $\nu$ , in centistokes, then convert to absolute viscosity  $\mu$ , in centipoise.

The conversions are approximate but satisfactory for viscosity correction in liquid safety valve sizing.

**TABLE 8-21 - VISCOSITY CONVERSION**

Seconds Viscosity Centistokes $\nu$	Seconds Saybolt Universal ssu	Seconds Saybolt Furot ssf	Seconds Redwood1 (standard)	Seconds Redwood2 (Admiralty)
1.00	31	-	29.0	-
2.56	35	-	32.1	-
4.30	40	-	36.2	5.10
7.40	50	-	44.3	5.83
10.3	60	-	52.3	6.77
13.1	70	12.95	60.9	7.60
15.7	80	13.70	69.2	8.44
18.2	90	14.40	77.6	9.30
20.6	100	15.24	85.6	10.12
32.1	150	19.30	128.0	14.48
43.2	200	23.50	170.0	18.90
54.0	250	28.00	212.0	23.45
65.0	300	32.50	254.0	28.00
87.60	400	41.90	338.0	37.10
110.0	500	51.60	423.0	46.20
132.0	600	61.40	508.0	55.40
154.0	700	71.10	592.0	64.60
176.0	800	81.00	677.0	73.80
198.0	900	91.00	462.0	83.00
220.0	1000	100.70	896.0	92.10
330.0	1500	150.00	1270.0	138.20
440.0	2000	200.00	1690.0	184.20
550.0	2500	250.00	2120.0	230.00
660.0	3000	300.00	2540.0	276.00
880.0	4000	400.00	3380.0	368.00
1100.0	5000	500.00	4230.0	461.00
1320.0	6000	600.00	5080.0	553.00
1540.0	7000	700.00	5920.0	645.00
1760.0	8000	800.00	6770.0	737.00
1980.0	9000	900.00	7620.0	829.00
2200.0	10000	1000.00	8460.0	921.00
3300.0	15000	1500.00	13700.0	-
4400.0	20000	2000.00	18400.0	-

### **XI - CAPACITY CORRECTION FACTOR FOR RUPTURE DISC/PRESSURE RELIEF VALVE COMBINATION, $K_c$**

---

It may be desirable to isolate a pressure relief valve from the process fluid in the vessel that it is protecting. A non-reclosing device such as a rupture disc can be installed upstream of the pressure relief valve to provide this isolation. For example, it may be more economical to install a rupture disc made from Inconel and then mount a standard stainless steel pressure relief valve in series with the disc where the service conditions require such a high alloy material. This rupture disc/pressure relief valve combination may also be beneficial when the fluid may have entrained solids or is viscous. The rupture disc can also provide for a zero leak point during normal vessel operation.

Since the rupture disc is in the flow path of the pressure relief valve, the ASME Section VIII Code mandates that the pressure relief valve rated capacity be adjusted with a capacity combination factor ( $K_c$ ). This correction factor is determined by performing actual flow tests with specific rupture disc and pressure relief valve designs. The materials of construction, minimum size, and minimum burst pressure of the rupture disc must be specified to use this measured correction factor.

If there has been no combination testing performed then the  $K_c$  factor is equal to 0.90.

Table 8-22 lists the combination tests performed with the Crosby J series direct acting spring loaded valves. For any other Crosby brand or Anderson Greenwood brand pressure relief valve product used in series with a rupture disc, use a  $K_c$  factor equal to 0.90.

PRESSURE RELIEF VALVE ENGINEERING HANDBOOK  
 CHAPTER 8 - ENGINEERING SUPPORT INFORMATION - METRIC UNITS

**TABLE 8-22 - Capacity Correction Factor for Rupture Disc/PRV Combination ( $K_c$ )**

Emerson PRV Series	Rupture disc manufacturer	Disc type	Minimum disc size (mm)	Minimum burst pressure (barg)	Disc material	$K_c$ Factor
J05-E/JBS-E	BS&B	CSR	40	3.45	Inconel®	0.986
		JRS	25	4.14	316 SS	0.993
		JRS	40	1.59	Monel®	0.981
		RLS	25	9.52	Monel®	0.981
		RLS	25	11.9	Hastelloy®	0.972
		RLS	50	5.83	Monel®	0.981
		S90	25	8.62	Nickel	0.995
		S90	50	5.17	Nickel	0.994
J05-E/JBS-E	Continental Disc	CDC	25	4.14	Monel®/Teflon®	0.971
		CDC-FS	80	1.03	Monel®/Teflon®	0.986
		CDCV FS	25	4.14	316 SS/Teflon®	0.985
		CDCV FS	25	4.14	Hastelloy®/Teflon®	0.983
		CDCV FS	40	2.07	316 SS/Teflon®	0.976
		CDCV FS	40	2.07	Hastelloy®/Teflon®	0.973
		CDCV FS	80	1.03	316 SS/Teflon®	0.982
		CDCV FS	80	1.03	Hastelloy®/Teflon®	0.981
		CDCV LL	25	4.14	316 SS/Teflon®	0.978
		CDCV LL	25	4.14	Hastelloy®/Teflon®	0.960
		CDCV LL	25	4.14	Monel®/Teflon®	0.961
		CDCV LL	40	2.07	316 SS/Teflon®	0.959
		CDCV LL	40	2.07	Monel®/Teflon®	0.958
		CDCV LL	40	2.07	Nickel/Teflon®	0.953
		CDCV LL	80	1.03	316 SS/Teflon®	0.953
		CDCV LL	80	1.03	Monel®/Teflon®	0.979
		DCV	80	2.41	Monel®/Teflon®	0.994
		DCV	80	2.41	316 SS/Teflon®	0.978
		KBA	25	4.14	Monel®	0.984
		Micro X	25	10.3	Monel®	0.984
		Micro X	25	10.3	Nickel	0.990
		Micro X	50	5.52	316 SS	0.991
		Micro X	50	5.52	Inconel®	0.997
		Micro X	50	5.52	Monel®	0.988
		Micro X	50	5.52	Nickel	0.992
		ULTRX	25	4.14	316 SS	0.980
		MINTRX	25	4.14	Hastelloy®	0.987
		STARX	25	4.14	Inconel®	0.984
		STARX	25	4.14	Monel®	0.980
		STARX	25	4.14	Nickel	0.981
		STARX	40	2.07	316 SS	0.984
		STARX	40	2.07	Hastelloy®	0.986
STARX	40	2.07	Inconel®	0.989		
STARX	40	2.07	Monel®	0.987		
STARX	40	2.07	Nickel	0.981		
STARX	40	2.07	Tantalum	0.978		
STARX	80	1.03	316 SS	0.985		
STARX	80	1.03	Hastelloy®	0.992		
STARX	80	1.03	Inconel®	0.991		
STARX	80	1.03	Monel®	0.987		
STARX	80	1.03	Nickel	0.981		

**TABLE 8-22 - Capacity correction factor for rupture disc/PRV combination ( $K_v$ ) (continued)**

Emerson PRV series	Rupture disc manufacturer	Disc type	Minimum disc size (mm)	Minimum burst pressure (barg)	Disc material	$K_c$ Factor
J05-E/JBS-E	Continental Disc	ZAP	25	4.14	Monel®	0.985
		ZAP	25	4.14	316 SS	0.985
		ZAP	25	4.14	Inconel®	0.988
		ZAP	25	4.14	Nickel	0.992
		ZAP	40	2.07	316 SS	0.955
		ZAP	40	2.07	Monel®	0.955
		ZAP	40	2.07	Nickel	0.992
		ZAP	80	2.41	Inconel®	0.992
		ZAP	80	2.41	Monel®	0.982
		ZAP	80	2.41	Nickel	1.000
		ZAP	80	2.41	316 SS	0.970
		J05-E/JBS-E	Fike	Axius	25	1.03
MRK	25			4.14	316 SS	0.967
MRK	25			4.14	Nickel	0.977
MRK	80			2.41	316 SS	0.982
MRK	80			2.41	Nickel	0.995
Poly-SD CS	25			8.55	Aluminum	0.970
Poly-SD DH	25			2.21	Aluminum	0.997
SRL	25			1.86	SS Nickel	0.979
SRX	25			6.55	Nickel	0.996
J05-E/JBS-E	OSECO	COV	50	2.14	Monel®/Teflon®	0.979
		FAS	80	6.21	Nickel	0.975
		PCR	80	6.21	Nickel	0.967